

# 2023

PASSION  
RIDES  
HERE

WORKBOOK



**PASSION  
RIDES  
HERE**

## IN DIRT WE TRUST ...

Racetech company, founded in 2002, was born for the two-wheeled world by the passion of its CEO Cristian Mittone who has been a pro-enduro rider.

We have a deep knowledge about Motocross and Off Road Racing, we know what it takes to achieve the goals needed to make great products; this is our strength!

We listen to our customers and our engineering results are summarized in our attitude: producing the highest quality, the best off-road products in the world!

We work constantly, continually improving what we create and sell, so we can share with you our great passion!

## WE ARE THE SOURCE

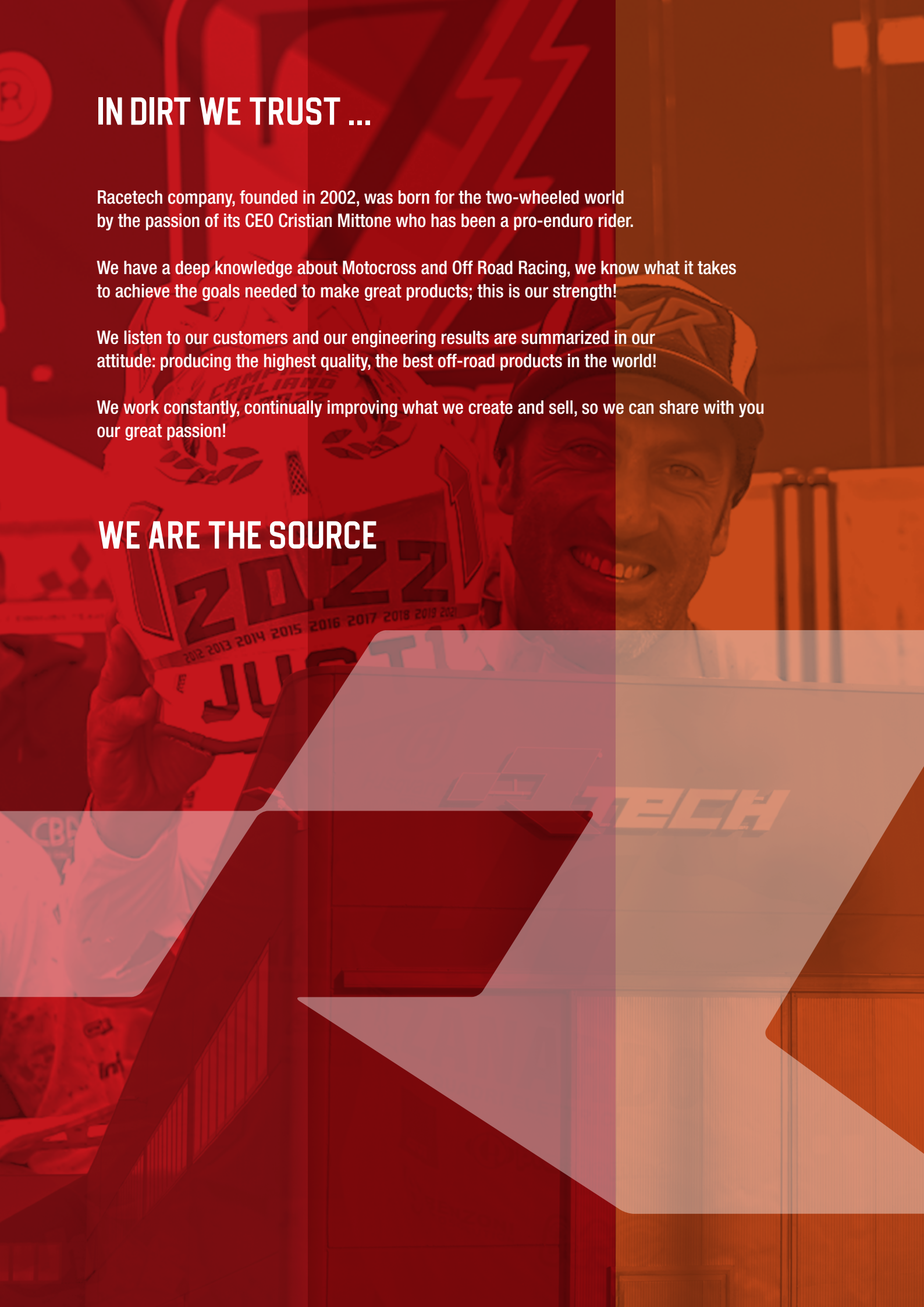



YZ REVOLUTION ..... pag 8  
 CRF REVOLUTION ..... pag 12

**HANDGUARDS / PARAMANI**



**HP1**  
pag. 18



**HP1 SCRAMBLER**  
pag. 21



**HP2**  
pag. 22



**HP3 MX / EN**  
pag. 26



**HP3 ADVENTURE**  
pag. 30



**FLX**  
pag. 32



**FLX ALU**  
pag. 34



**FLX ATV**  
pag. 36



**VERTIGO**  
pag. 38



**VERTIGO ALU**  
pag. 40



**VERTIGO ATV**  
pag. 41



**GLADIATOR EASY**  
pag. 42



**GLADIATOR ALU**  
pag. 43



**DUAL EVO**  
pag. 44



**RAPTOR**  
pag. 46



**PUMP GUARDS**  
pag. 47



**MOUNTING KIT**  
pag. 48

**GRIPS / MANOPOLE**



**R20 LOCK-ON**  
pag. 51



**WAVE**  
pag. 53



**RACING**  
pag. 54



**FULL DIAMOND**  
pag. 56



**ACCESSORIES**  
pag. 57

**HEADLIGHT / MASCHERINE PORTAFARO**



**V-FACE**  
pag. 60



**GENESIS**  
pag. 64



**MATRIX**  
pag. 65



**REPLACE PARTS**  
pag. 66



**KIT LED 3000**  
pag. 68

**TAIL-LIGHT / PORTATARGA**



**INTEGRA**  
pag. 70



**KTM  
HUSQVARNA  
INTEGRA**  
pag. 73



**GASGAS  
BETA  
INTEGRA**  
pag. 75



**REPLACE PARTS**  
pag. 76



**EXTREME RACING**  
pag. 78



**DEVIL**  
pag. 79

REPLICA PLASTICS / PLASTICHE REPLICA

HONDA ..... pag 81  
 YAMAHA ..... pag 101  
 KAWASAKI ..... pag 125  
 SUZUKI ..... pag 141  
 KTM ..... pag 153  
 HUSABERG ..... pag 189  
 HUSQVARNA ..... pag 195  
 GAS GAS ..... pag 221  
 BETA ..... pag 229



UNIVERSAL FRONT FENDER / PARAFANGHI ANTERIORI UNIVERSALI .... pag 236  
 CHAIN ROLLER / RULLI SCORRICATENA .... pag 237

PROTECTIONS / PROTEZIONI



**ENGINE GUARDS**  
pag. 240



**RADIATOR GUARDS**  
pag. 246



**DISC PROTECTOR**  
pag. 248



**SWINGARM PROTECTORS**  
pag. 250



**FRAME PROTECTOR**  
pag. 251



**CHAIN GUIDE**  
pag. 254

TRACK WORKSHOP / BOX OFFICINA GARA



**BIKE STAND**  
pag. 258



**TIRE LEVERS**  
pag. 262



**TIRE CHANGER**  
pag. 263



**RIM LOCK**  
pag. 264



**AIR VALVE PULLER**  
pag. 264



**TIRE PRESSURE GAUGE**  
pag. 264

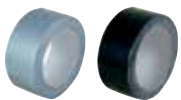

**NASHUA TAPE**  
pag. 264



**WIRE PLIERS**  
pag. 264



**MX BOOT WASH STEEL STAND**  
pag. 264



**ZIP TIES**  
pag. 265



**MUD REMOVER CHAIN BRUSH**  
pag. 265



**RETICULATED FOAM**  
pag. 265



**R15 GAS CAN**  
pag. 266



**ECO TANKS**  
pag. 269



**PADDOCK AND GARAGE MAT**  
pag. 269



**HOURLY METER**  
pag. 270



**STARTING BLOCKS**  
pag. 271



**FOLDING RAMP**  
pag. 272



**EXTREME ENDURO FRONT STRAP**  
pag. 272



**SILENCER END CAPS**  
pag. 272



**TIE DOWNS**  
pag. 273

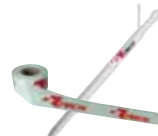

**TRACK MARKER**  
pag. 274



**PIT BOARD**  
pag. 275



**NUMBER STICKERS**  
pag. 275

**FUEL SYSTEM / SISTEMA DI ALIMENTAZIONE**



**GAS TANK CAP**  
pag. 278



**FUEL HOSE BREATHER**  
pag. 278



**AIR FILTER**  
pag. 279



**BIO WASH KIT**  
pag. 283



**AIR BOX WASH COVER**  
pag. 284



**ANTI-SLOSH FUEL TANK FOAM**  
pag. 286



**SEAT FOAMS**  
pag. 287

**HANDLEBARS / MANUBRI**



**ø22 - ø28,6**  
pag. 292



**PADS**  
pag. 297



**ADAPTERS**  
pag. 298



**RISER**  
pag. 298

**CONTROLS, LEVERS / COMANDI, LEVE**



**LEVERS**  
pag. 302



**TROTTLER TUBE**  
pag. 385



**BRAKE PEDAL**  
pag. 307



**SHIFT LEVER**  
pag. 308



**LIFT CONTROL**  
pag. 310



**FORK BLEEDER**  
pag. 311



**GAS TANK VALVE**  
pag. 311



**STEEL SCREWS**  
pag. 311

APPAREL / ABBIGLIAMENTO



**SWEATSHIRT,  
T-SHIRT, SHIRT**  
pag. 314



**CAP - BEANIE**  
pag. 315



**BOMBER JACKET**  
pag. 316



**GILET**  
pag. 316



**PANTS / SHORT**  
pag. 317

RACE / GARA / MERCHANDISING



**WAIST PACK**  
pag. 318



**WATER BOTTLE**  
pag. 318



**BACKPACK**  
pag. 318



**UMBRELLA**  
pag. 319



**FOLDING CHAIR**  
pag. 319



**LED TORCH**  
pag. 319



**SHOPPERS**  
pag. 319



**KEY HOLDER**  
pag. 319



**RACE TENT**  
pag. 320



**RACE MAT**  
pag. 321



**FLAG**  
pag. 321



**PRODUCT DISPLAY**  
pag. 321

> WORLD DISTRIBUTION <



pag. 322

> ITALY DISTRIBUTION <



pag. 354





***YZ Revolution***  
***CRF Revolution***



The graphic represented in the photo is not included into the plastic kit. For more information about graphic kit please contact - info@thebos.it

Le grafiche in foto non sono comprese con il kit. Per informazioni sulle grafiche contattare - info@thebos.it

**DOWNLOAD**  
YZ Revolution graphic template  
Tracciato grafiche YZ Revolution  
[www.rtechmx.com](http://www.rtechmx.com)

## CHANGE THE LOOK OF YOUR YAMAHA YZ

YZ-X 125-250 2016 > 2021 · YZ 125-250 2002 > 2021

OEM original color - ☀ fluorescent color

| COMPONENT                                 | NOTES   | COLOR                     | CODE           | PRICE               |               |                |         |
|---|---|---------------------------|----------------|---------------------|---------------|----------------|---------|
| <b>Front Fender</b>                       | Vented front fender - to drill                        | YZ Blue                   | R-PAYZFBLL9911 | € 29,95             |               |                |         |
|   |   | White                     | R-PAYZFBN9911  |                     |               |                |         |
|   |   | Neon Yellow ☀             | R-PAYZFGF9911  |                     |               |                |         |
|   |   | Y Yellow                  | R-PAYZFGY9911  |                     |               |                |         |
|   |   | Black                     | R-PAYZFNR9911  |                     |               |                |         |
|   |   | Quantum Grey              | R-PAYZFGR9911  |                     |               |                |         |
|   |   | Ducati Neon Red ☀         | R-PAYZFRD9911  |                     |               |                |         |
|   |   | <b>Rear Fender</b>        |                |                     | YZ Blue       | R-PPYZ0BL0015  | € 31,95 |
|   |   |                           |                |                     | White         | R-PPYZ0BN0015  |         |
|   |   |                           |                |                     | Neon Yellow ☀ | R-PPYZ0GF0015  |         |
| Y Yellow                                  | R-PPYZ0GY0015   |                           |                |                     |               |                |         |
| Black                                     | R-PPYZ0NR0015   |                           |                |                     |               |                |         |
| Quantum Grey                              | R-PPYZ0GR0015   |                           |                |                     |               |                |         |
| Ducati Neon Red                           | R-PPYZ0RD0015   |                           |                |                     |               |                |         |
| <b>Revolution Radiator Scoops</b>         | Bi-Color<br>Bi-Color<br>Bi-Color<br>Bi-Color          |                           |                | YZ Blue-Black       | R-CVYZ0BL0016 | € 59,95        |         |
|   |   |                           |                | White-Black         | R-CVYZ0BN0016 |                |         |
|   |   |                           |                | Neon Yellow-Black ☀ | R-CVYZ0GF0016 |                |         |
|   |   | Y Yellow-Black            | R-CVYZ0GY0016  |                     |               |                |         |
|   |   | Black                     | R-CVYZ0NR0016  |                     |               |                |         |
|   | Bi-Color<br>Bi-Color                                  | Quantum Grey              | R-CVYZ0GR0016  |                     |               |                |         |
|   |   | Ducati Neon Red ☀         | R-CVYZ0RD0016  |                     |               |                |         |
| <b>Revolution Airbox Side Panels</b>      | Only for Revolution side panels                       | Black                     | R-FILCFYZNR16  | € 52,95             |               |                |         |
| <b>Revolution Side Panels</b>             | Matches only with Revolution airbox side panels       | YZ Blue                   | R-FIYZ0BL0016  | € 52,95             |               |                |         |
|   |   | White                     | R-FIYZ0BN0016  |                     |               |                |         |
|   |   | Neon Yellow ☀             | R-FIYZ0GF0016  |                     |               |                |         |
|   |   | Y Yellow                  | R-FIYZ0GY0016  |                     |               |                |         |
|   |   | Black                     | R-FIYZ0NR0016  |                     |               |                |         |
|   |   | Quantum Grey              | R-FIYZ0GR0016  |                     |               |                |         |
|   |   | Ducati Neon Red ☀         | R-FIYZ0RD0016  |                     |               |                |         |
|   |   | <b>Front Number Plate</b> |                |                     | YZ Blue       | R-TBYZFBLL0010 | € 28,95 |
| White                                     | R-TBYZFBN0010   |                           |                |                     |               |                |         |
| Y Yellow                                  | R-TBYZFGY0010   |                           |                |                     |               |                |         |
| Neon Yellow ☀                             | R-TBYZFGF0010   |                           |                |                     |               |                |         |
| Black                                     | R-TBYZFNR0010   |                           |                |                     |               |                |         |
| CR Red                                    | R-TBYZFRS0010   |                           |                |                     |               |                |         |
| Quantum Grey                              | R-TBYZFGR0010   |                           |                |                     |               |                |         |
| Ducati Neon Red ☀                         | R-TBYZFRD0010   |                           |                |                     |               |                |         |
| <b>Front Number Plate Adaptor</b>         | To fit 2015-21 front number plate on 2002>2005 models |                           |                | Red                 | R-SUPTABYZ915 | € 18,95        |         |
| <b>Revolution Gas Tank 2002 &gt; 2014</b> | adapt. to 02=>14 models with Revolution rad. scoops   |                           |                | Black               | R-SERYZ016NR0 | € 229,95       |         |
| <b>Revolution Tank Cap</b>                |   | Black                     | R-TAPPOYZREV1  | € 19,95             |               |                |         |

Revolution plastic kit included gas tank, tank cap and number plate adaptor  
Il kit Revolution include serbatoio con tappo e kit di fissaggio tabella anteriore

price € 399,95



OEM - cod. R-KITYZO-BL0-016



White - cod. R-KITYZO-BN0-016



Quantum Grey - cod. R-KITYZO-GR0-016



Ducati Neon Red - cod. R-KITYZO-RD0-016



Neon Yellow - cod. R-KITYZO-GF0-016



Black - cod. R-KITYZO-NR0-016



Y Yellow - cod. R-KITYZO-GY0-016



Full Blue - cod. R-KITYZO-BL1-016

Revolution Replacement plastic kit without gas tank, tank cap and front number plate adaptor  
Il kit Revolution Replacement NON include serbatoio con tappo e kit di fissaggio tabella anteriore

**price € 164,95**



OEM - cod. R-KITYZO-BL0-REV



White - cod. R-KITYZO-BN0-REV



Quantum Grey - cod. R-KITYZO-GR0-REV



Ducati Neon Red - cod. R-KITYZO-RD0-REV



**NEON**

Neon Yellow - cod. R-KITYZO-GF0-REV



Black - cod. R-KITYZO-NR0-REV



Y Yellow - cod. R-KITYZO-GY0-REV



Full Blue - cod. R-KITYZO-BL1-REV



TANK CAP - Black  
cod. R-TAPPOYZREV1 - € 19,95



REVOLUTION GAS TANK - Black  
cod. R-SERYZ016NR0 - € 229,95  
**TANK CAP NOT INCLUDED**



AIRBOX SIDE PANELS  
Black Carbon Look  
cod. R-FILCFYZNR16 - € 52,95



FRONT NUMBER PLATE ADAPTOR  
cod. R-SUPTABYZ915 - € 18,95



RADIATOR SCOOPS - YZ Blue-Black  
cod. R-CVYZ0BL0016 - € 59,95



SIDE PANELS - YZ Blue  
cod. R-FIYZ0BL0016 - € 52,95



RADIATOR SCOOPS - Ducati Neon Red  
cod. R-CVYZ0RD0016 - € 59,95



SIDE PANELS - Ducati Neon Red  
cod. R-FIYZ0RD0016 - € 52,95



RADIATOR SCOOPS - Y Yellow-Black  
cod. R-CVYZ0GY0016 - € 59,95



SIDE PANELS - Y Yellow  
cod. R-FIYZ0GY0016 - € 52,95



RADIATOR SCOOPS - Neon Yellow-Black  
cod. R-CVYZ0GF0016 - € 59,95

**NEON**



SIDE PANELS - Neon Yellow  
cod. R-FIYZ0GF0016 - € 52,95



RADIATOR SCOOPS - Black  
cod. R-CVYZ0NR0016 - € 59,95



SIDE PANELS - Black  
cod. R-FIYZ0NR0016 - € 52,95



RADIATOR SCOOPS - White-Black  
cod. R-CVYZ0BN0016 - € 59,95



SIDE PANELS - White  
cod. R-FIYZ0BN0016 - € 52,95



RADIATOR SCOOPS - Quantum Grey  
cod. R-CVYZ0GR0016 - € 59,95



SIDE PANELS - Quantum Grey  
cod. R-FIYZ0GR0016 - € 52,95

### **New concept CRF 2021>2023**

re-designed plastic kit composed by:

- new factory front number plate
- new slimmer and modern shrouds
- new streamline side number panels
- vented front fender
- reinforced rear fender
- fork protectors



DOWNLOAD  
CRF Revolution graphic template  
*Tracciato grafiche CRF Revolution*  
[www.rtechmx.com](http://www.rtechmx.com)

**CRF**

**EVOLUTION**

CHANGE THE LOOK OF YOUR

**HONDA CRF**

CRF 250 2022-2023 · CRF 450 2021>2023 · CRF-RWE 450 2021>2023

**ORIGINAL**



**REVOLUTION**





**CRF** **Evolution**



OEM - cod. R-KITCRF-RS0-522



OEM - cod. R-KITCRF-BN0-522

**Full plastic kit - 179.95€**



OEM - cod. R-KITCRF-GR0-522



OEM - cod. R-KITCRF-NR0-522



Full plastic kit 179.95€  
 Fork protectors - Front fender - Rear fender  
 Revolution radiator scoops - Revolution side panels - Factory front number plate

| PLASTICS KIT | COLOR        |  | CODE             | PRICE    |
|--------------|--------------|--|------------------|----------|
|              | OEM          |  | R-KITCRF-RS0-522 | € 179,95 |
|              | White        |  | R-KITCRF-BN0-522 | € 179,95 |
|              | Black        |  | R-KITCRF-NR0-522 | € 179,95 |
|              | Quantum Grey |  | R-KITCRF-GR0-522 | € 179,95 |

**OEM** original color - fluorescent color

| COMPONENT                         | NOTES  | COLOR              |  | CODE          | PRICE   |
|-----------------------------------|--|--------------------|--|---------------|---------|
| <b>Front Fender</b>               | OEM - vented front fender  | CR Red             |  | R-PACRFRS9921 | € 29,95 |
|                                   | vented front fender  | White              |  | R-PACRFBN9921 |         |
|                                   | vented front fender  | Black              |  | R-PACRFNR9921 |         |
|                                   | vented front fender  | Quantum Grey       |  | R-PACRFRG9921 |         |
| <b>Rear Fender</b>                | OEM  | CR Red             |  | R-PPCRFRS0021 | € 32,95 |
|                                   |  | White              |  | R-PPCRFBN0021 |         |
|                                   |  | Black              |  | R-PPCRFNR0021 |         |
|                                   |  | Quantum Grey       |  | R-PPCRFRG0021 |         |
| <b>Revolution Radiator Scoops</b> | CRF/CRF-RX 250 2022<br>CRF-R/CRF-RWE/CRF-RX 450 2021-2022  | CR Red             |  | R-CVCRFRS0022 | € 65,95 |
|                                   |  | White              |  | R-CVCRFBN0022 |         |
|                                   |  | Black              |  | R-CVCRFNR0022 |         |
|                                   |  | Quantum Grey       |  | R-CVCRFRG0022 |         |
| <b>Revolution Side Panels</b>     | CRF/CRF-RX 250 2022<br>CRF-R/CRF-RX/CRF-RWE 450 2021-2022  | CR Red-Black       |  | R-FICRFRSNR22 | € 79,95 |
|                                   |  | White-Black        |  | R-FICRFBNNR22 |         |
|                                   |  | Black              |  | R-FICRFNR0022 |         |
|                                   |  | Quantum Grey-Black |  | R-FICRFRG0022 |         |
| <b>Front Number Plate</b>         | OEM - <b>FACTORY</b> front number plate<br><b>FACTORY</b> front number plate<br><b>FACTORY</b> front number plate<br><b>FACTORY</b> front number plate | CR Red             |  | R-TBCRFRS0022 | € 38,95 |
|                                   |  | White              |  | R-TBCRFBN0022 |         |
|                                   |  | Black              |  | R-TBCRFNR0022 |         |
|                                   |  | Quantum Grey       |  | R-TBCRFRG0022 |         |
| <b>Fork Protectors</b>            | OEM  | CR Red             |  | R-PSCRFRS0019 | € 34,95 |
|                                   |  | White              |  | R-PSCRFBN0019 |         |
|                                   |  | Black              |  | R-PSCRFNR0019 |         |
|                                   |  | YZ Blue            |  | R-PSCRFBL0019 |         |
|                                   |  | Neon Yellow        |  | R-PSCRFGF0019 |         |
|                                   | Limited Edition  | Quantum Grey       |  | R-PSCRFRG0019 |         |



EIKON

EICMA FIM Federazione Motoristica Italiana

FP

Martini

SEBINO camuno

GRAD  
TRAC



## **HANDGUARDS**

*HP1 >pag 18*

*HP1 Scrambler >pag 21*

*HP2 >pag 22*

*HP3 >pag 26*

*HP3 Adventure >pag 30*

*FLX >pag 32*

*FLX ALU >pag 34*

*FLX ATV >pag 36*

*Vertigo >pag 38*

*Vertigo ALU >pag 40*

*Vertigo ATV >pag 41*

*Gladiator Easy >pag 42*

*Gladiator Alu >pag 43*

*Dual Evo >pag 44*

*Raptor >pag 46*

*Pump Guards >pag 47*

*Mounting Kit >pag 48*

## **GRIPS**

*R20 Lock-On grips >pag 50*

*Wave grips >pag 53*

*Racing grips >pag 54*

*Full Diamond >pag 56*

*Grips Accessories >pag 57*



€ 43.95



- Made by bi-material, resistant and flexible
- Excellent durability, lightness and ventilation
- **Permanent co-injected R logo**
- Adjustable in different side positions
- Includes both handlebar and lever mounts kit
- Replacement shield plastics as spare part suitable for Ktm, Gas Gas, Husqvarna and Sherco using stock brackets

- *Realizzati in bi-materiale, robusto e flessibile*
- *Eccellente resistenza, leggerezza e ventilazione*
- **Logo co-stampato in maniera permanente**
- *Regolabile lateralmente in differenti posizioni*
- *Inclusi kit di montaggio al manubrio ed alle leve*
- *Placche di ricambio adatte agli originali kit di montaggio Ktm, Gas Gas, Husqvarna e Sherco*

2x **UNIVERSAL MOUNTING KIT INCLUDED**



Universal handlebar mounting kit  
Kit montaggio al manubrio Universale



Universal lever mounting kit  
Kit montaggio alle leve Universale

## > MOUNTING - MONTAGGIO

### Handlebar mounting kit Kit montaggio al manubrio



### Lever mounting kit Kit montaggio alle leve



- Extra strong
- *Extra resistenti*
- Possible horizontal side regulation
- *Possibilità di regolazione orizzontale*
- Clutch hose protection
- *Protezione tubo-frizione*

Available colors - *Colori disponibili*



White - **R-KITPMHP1BN0**



Black - **R-KITPMHP1NR0**



KX Green - **R-KITPMHP1VE0**



K Orange - **R-KITPMHP1AR0**



CR Red - **R-KITPMHP1RS0**



YZ Blue - **R-KITPMHP1BL0**



Neon Orange - **R-KITPMHP1AN0**



RM Yellow - **R-KITPMHP1GI0**



Neon Yellow - **R-KITPMHP1GF0**

> REPLACEMENT PARTS - RICAMBI PARAMANI

Replacement plastic shield - *Plastiche di ricambio*



fluorescent color

| COLOR       | CODE                 | PRICE   |
|-------------|----------------------|---------|
| White       | <b>R-REPPMHP1BN0</b> | € 24,95 |
| Black       | <b>R-REPPMHP1NR0</b> | € 24,95 |
| CR Red      | <b>R-REPPMHP1RS0</b> | € 24,95 |
| K Orange    | <b>R-REPPMHP1AR0</b> | € 24,95 |
| Neon Orange | <b>R-REPPMHP1AN0</b> | € 24,95 |
| YZ Blue     | <b>R-REPPMHP1BL0</b> | € 24,95 |
| RM Yellow   | <b>R-REPPMHP1GI0</b> | € 24,95 |
| KX Green    | <b>R-REPPMHP1VE0</b> | € 24,95 |
| Neon Yellow | <b>R-REPPMHP1GF0</b> | € 24,95 |
| GG Red      | <b>R-REPPMHP1RG0</b> | € 24,95 |

Replacement shield plastics as spare part suitable for KTM, GAS GAS, HUSQVARNA and SHERCO stock brackets.  
*Plastiche di ricambio adattabili ai supporti paramano originali KTM - GAS GAS - HUSQVARNA - SHERCO.*

Replacement Mounting Kit - *Ricambi kit di montaggio*



€ 16.95

Handlebar mounting kit - *Kit montaggio al manubrio*  
**R-KITSUPHP2NR**



€ 16.95

Lever mounting kit - *Kit montaggio alle leve*  
**R-KITSUPHP1NR**

**GASGAS EC/ECF 2021>2023 | HUSQVARNA TE/FE 2020>2023**

With specific **Braketec** nylon mounting kit on the levers / Forniti con kit montaggio alle leve specifico **Braketec**

**NEW**

€ 38.95

**2x** **SPECIFIC MOUNTING KIT INCLUDED**

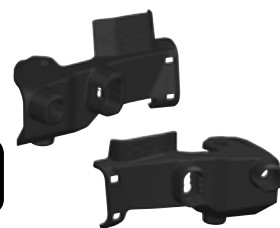

White - **R-KITPMHP1BN3**



Black - **R-KITPMHP1NR3**



YZ Blue - **R-KITPMHP1BL3**



CR Red - **R-KITPMHP1RG3**



CR Red - **R-KITPMHP1RS3**

**NEON**



Neon Yellow - **R-KITPMHP1GF3**

**HONDA CRF 250 2022-2023 CRF 450 2021>2023  
KAWASAKI KX 250 2021>2023 KX 450 2019>2023**

With specific **Nissin** nylon mounting kit on the levers - Forniti con kit montaggio alle leve specifico per **Nissin**  
Only for Hydraulic clutch pump / Solo per frizione idraulica

**NEW**

€ 38.95

**2x** **SPECIFIC MOUNTING KIT INCLUDED**



White - **R-KITPMHP1BN4**



Black - **R-KITPMHP1NR4**



KX Green - **R-KITPMHP1VE4**



CR Red - **R-KITPMHP1RS4**

**> REPLACEMENT PARTS - RICAMBI PARAMANI**

**Replacement plastic shield - Plastiche di ricambio**



☀ fluorescent color

| COLOR       | CODE            | PRICE   |
|-------------|-----------------|---------|
| White       | R-REPPMHP1BN0   | € 24,95 |
| Black       | R-REPPMHP1NR0   | € 24,95 |
| CR Red      | R-REPPMHP1RS0   | € 24,95 |
| K Orange    | R-REPPMHP1AR0   | € 24,95 |
| Neon Orange | ☀ R-REPPMHP1AN0 | € 24,95 |
| YZ Blue     | R-REPPMHP1BL0   | € 24,95 |
| RM Yellow   | R-REPPMHP1GI0   | € 24,95 |
| KX Green    | R-REPPMHP1VE0   | € 24,95 |
| Neon Yellow | ☀ R-REPPMHP1GF0 | € 24,95 |
| GG Red      | R-REPPMHP1RG0   | € 24,95 |

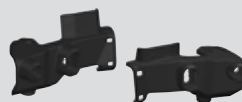

Specific Braketec nylon mounting kit on the levers  
Kit montaggio alle leve specifico Braketec  
**R-KITSUPHP3NR**

€ 16.95

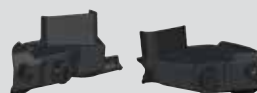

Specific Kawasaki KX/Honda CRF nylon mounting kit on the levers  
Kit montaggio alle leve specifico Kawasaki KX/Honda CRF  
**R-KITSUPHP4NR**

€ 16.95



€ 94.95

- The clean shape makes a perfect combination with naked and scrambler street bikes
- Realized in bi-material, resistant and flexible
- Excellent durability, lightness and ventilation
- Thanks to the "double expander" mounting kit allows an easy installation eliminating the possibility of rotation after locking
- Available with silver or black anodized aluminum bars

- La linea pulita e filante si abbina perfettamente alle più diffuse moto scrambler e naked
- Realizzati in bi-materiale, robusto e flessibile
- Eccellente resistenza, leggerezza e ventilazione
- Facile da montare grazie al kit di montaggio con espansore a "doppio cono" che ne evita la rotazione dopo il bloccaggio
- Disponibile con barre in alluminio anodizzato silver o nero



Steel galvanized expanders for handlebars with inner hole  
Espansori in acciaio zincato per manubri in acciaio con foro interno



ø 14-18 mm



ø 16-17 mm



ø 18-20,5 mm



**BLACK BAR**  
HP1 handguards with black aluminium bars  
**R-KITPMHP1NR2**



**GREY BAR**  
HP1 handguards with grey aluminium bars  
**R-KITPMHP1NR1**

-  UNIVERSAL MOUNTING
-  SCRAMBLER DUAL ROAD
-  VENTILATION
-  ADVENTURE NAKED
-  ALL TERRAIN
-  LIGHT WEIGHT
-  BI-MATERIAL

# HANDGUARDS - PARAMANI HP2



€ 38.95



## The only one that offers the possibility of being used upside down!!

- Made by a special technopolymer material
- Allows the maximum strength in the central section and an elastic rubber surface carbon look all around
- Excellent durability, lightness and ventilation
- Ipl permanent graphic
- Adjustable in different side positions
- Handlebar mounting kit included
- Replacement shield plastics as spare part suitable for KTM, Gas Gas, Husqvarna and Sherco using stock brackets
- **Enduro World Champion 2020, 2021, 2022 Team Beta Factory**

## Gli unici che offrono la possibilità' di essere montati in due varianti opposte!!

- Realizzati in uno speciale tecnopolimero
- Massima resistenza nella parte centrale, superficie gommata e flessibile con effetto carbonio tutt'attorno
- Eccellente resistenza, leggerezza e ventilazione
- Grafica permanente ipl co-stampata
- Regolabile lateralmente in differenti posizioni
- Incluso kit di montaggio al manubrio
- Placche di ricambio adatte agli originali kit di montaggio KTM, Gas Gas, Husqvarna e Sherco
- **Campione del Mondo assoluto enduro 2020, 2021 e 2022 Team Beta Factory**



Handlebar mounting kit, up to the levers  
Kit montaggio al manubrio, sopra le leve



## > MOUNTING - MONTAGGIO

The only one that offers the possibility of being used upside down!!

Gli unici che offrono la possibilità' di essere montati in due varianti opposte!!



Available colors - *Colori disponibili*



**NEON**

Neon Orange - **R-KITPMHP2AN0**



Black - **R-KITPMHP2NR0**



White - **R-KITPMHP2BN0**



K Orange - **R-KITPMHP2AR0**



YZ Blue - **R-KITPMHP2BL0**



**NEON**

Neon Yellow - **R-KITPMHP2GF0**



RM Yellow - **R-KITPMHP2GI0**



CR Red - **R-KITPMHP2RS0**



KX Green - **R-KITPMHP2VE0**

> REPLACEMENT PARTS - RICAMBI PARAMANI

Replacement plastic shield - *Plastiche di ricambio*



fluorescent color

| COLOR       | CODE                 | PRICE   |
|-------------|----------------------|---------|
| White       | <b>R-REPPMHP2BN0</b> | € 24,95 |
| Black       | <b>R-REPPMHP2NR0</b> | € 24,95 |
| CR Red      | <b>R-REPPMHP2RS0</b> | € 24,95 |
| K Orange    | <b>R-REPPMHP2AR0</b> | € 24,95 |
| Neon Orange | <b>R-REPPMHP2AN0</b> | € 24,95 |
| YZ Blue     | <b>R-REPPMHP2BL0</b> | € 24,95 |
| RM Yellow   | <b>R-REPPMHP2GI0</b> | € 24,95 |
| KX Green    | <b>R-REPPMHP2VE0</b> | € 24,95 |
| Neon Yellow | <b>R-REPPMHP2GF0</b> | € 24,95 |
| GG Red      | <b>R-REPPMHP2RG0</b> | € 24,95 |

Replacement shield plastics as spare part suitable for KTM, GAS GAS, HUSQVARNA and SHERCO stock brackets.  
*Plastiche di ricambio adattabili ai supporti paramano originali KTM - GAS GAS - HUSQVARNA - SHERCO.*

Replacement Mounting Kit - *Ricambi kit di montaggio*



**€ 16.95**

Handlebar mounting kit - *Kit montaggio al manubrio*  
**R-KITSUPHP2NR**

**OPTIONAL**



**€ 16.95**

Lever mounting kit - *Kit montaggio alle leve*  
**R-KITSUPHP1NR**

**GASGAS EC/ECF 2021>2023 | HUSQVARNA TE/FE 2020>2023**

With specific **Braketec** nylon mounting kit on the levers / *Forniti con kit montaggio alle leve specifico **Braketec***

**NEW**

€ 38.95

**2x** **SPECIFIC MOUNTING KIT INCLUDED**

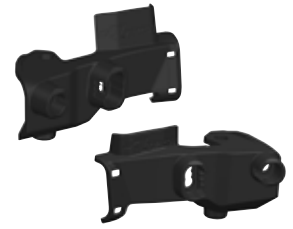

Black - **R-KITPMHP2NR3**



White - **R-KITPMHP2BN3**



CR Red - **R-KITPMHP2RS3**



YZ Blue - **R-KITPMHP2RG3**



YZ Blue - **R-KITPMHP2BL3**



Neon Yellow - **R-KITPMHP2GF3**

**NEON**

**NEW**

**HONDA CRF 250 2022-2023 CRF 450 2021-2023  
KAWASAKI KX 250 2021>2023 KX 450 2019>2023**

With specific **Nissin** nylon mounting kit on the levers - *Forniti con kit montaggio alle leve specifico per **Nissin***  
Only for Hydraulic clutch pump / *Solo per frizione idraulica*

€ 38.95

**2x** **SPECIFIC MOUNTING KIT INCLUDED**



Black - **R-KITPMHP2NR4**



White - **R-KITPMHP2BN4**



KX Green - **R-KITPMHP2VE4**



CR Red - **R-KITPMHP2RS4**

**> REPLACEMENT PARTS - RICAMBI PARAMANI**

**Replacement plastic shield - *Plastiche di ricambio***

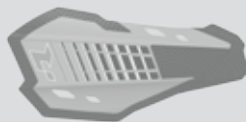

💡: fluorescent color

| COLOR       | CODE          | PRICE   |
|-------------|---------------|---------|
| White       | R-REPPMHP2BN0 | € 24,95 |
| Black       | R-REPPMHP2NR0 | € 24,95 |
| CR Red      | R-REPPMHP2RS0 | € 24,95 |
| K Orange    | R-REPPMHP2AR0 | € 24,95 |
| Neon Orange | R-REPPMHP2AN0 | € 24,95 |
| YZ Blue     | R-REPPMHP2BL0 | € 24,95 |
| RM Yellow   | R-REPPMHP2GI0 | € 24,95 |
| KX Green    | R-REPPMHP2VE0 | € 24,95 |
| Neon Yellow | R-REPPMHP2GF0 | € 24,95 |
| GG Red      | R-REPPMHP2RG0 | € 24,95 |



Specific **Braketec** nylon mounting kit on the levers  
*Kit montaggio alle leve specifico **Braketec***  
**R-KITSUPHP3NR**

€ 16.95

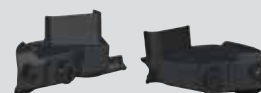

Specific **Kawasaki KX/Honda CRF** nylon mounting kit on the levers  
*Kit montaggio alle leve specifico **Kawasaki KX/Honda CRF***  
**R-KITSUPHP4NR**

€ 16.95



# HANDGUARDS - PARAMANI HP3 CROSS / ENDURO



€ 43.95

-  UNIVERSAL MOUNTING
-  ENDURO
-  VENTILATION
-  MOTOCROSS
-  LIGHT WEIGHT
-  BI-MATERIAL

- Made by a special technopolymer material, strong and flexible
- Excellent durability, lightness and ventilation
- Adjustable in different side positions
- Supplied by 2 mount kits, to the handlebar and perch levers
- Replacement shield plastics as spare part suitable for KTM, Gas Gas, Husqvarna and Sherco using stock brackets



- *Realizzati in uno speciale tecnopolimero robusto e flessibile*
- *Eccellente durata, leggerezza e ventilazione*
- *Regolabile lateralmente in differenti posizioni*
- *Incluso kit di montaggio al manubrio ed alle leve*
- *Placche di ricambio adatte agli originali kit di montaggio KTM, Gas Gas, Husqvarna e Sherco*



Handlebar mounting kit - *Kit montaggio al manubrio*

**2x** UNIVERSAL MOUNTING KIT INCLUDED



Lever mounting kit - *Kit montaggio alle leve*



## Available colors - Colori disponibili



Black - **R-HP3ENDNR000**



White/Black - **R-HP3ENDBNNR0**



**NEON**

Black/ Neon Orange - **R-HP3ENDNRANO**



K Orange/Black - **R-HP3ENDARNR0**



KX Green/Black - **R-HP3ENDVENR0**



RM Yellow/Black - **R-HP3ENDGINR0**



**NEON**

Black/ Neon Yellow - **R-HP3ENDNRGFO**



CR Red/White - **R-HP3ENDRSBNO**



Quantum Grey/Black - **R-HP3ENDGRNR0**



YZ Blue/White - **R-HP3ENDBLBNO**

## > REPLACEMENT PARTS – RICAMBI PARAMANI

### Replacement plastic shield - *Plastiche di ricambio*



fluorescent color

| COLOR              | CODE                 | PRICE   |
|--------------------|----------------------|---------|
| K Orange/Black     | <b>R-HP3REPARNR0</b> | € 24,95 |
| YZ Blue/White      | <b>R-HP3REPBLBNO</b> | € 24,95 |
| White/Black        | <b>R-HP3REPBNNR0</b> | € 24,95 |
| RM Yellow/Black    | <b>R-HP3REPGINR0</b> | € 24,95 |
| Black/Neon yellow  | <b>R-HP3REPNRGFO</b> | € 24,95 |
| Black/Neon orange  | <b>R-HP3REPNRANO</b> | € 24,95 |
| Quantum grey/Black | <b>R-HP3REPGRNR0</b> | € 24,95 |
| Black              | <b>R-HP3REPNR000</b> | € 24,95 |
| CR Red/White       | <b>R-HP3REPRSBNO</b> | € 24,95 |
| KX Green/Black     | <b>R-HP3REPVENR0</b> | € 24,95 |

### Replacement Mounting Kit - *Ricambi kit di montaggio*



**€ 16.95**

Handlebar mounting kit - *Kit montaggio al manubrio*  
**R-KITSUPHP2NR**



**€ 16.95**

Lever mounting kit - *Kit montaggio alle leve*  
**R-KITSUPHP1NR**

**GASGAS EC/ECF 2021>2023 | HUSQVARNA TE/FE 2020>2023**

With specific **Braketec** nylon mounting kit on the levers / *Forniti con kit montaggio alle leve specifico **Braketec***

**NEW**



White/Black - **R-KITPMHP3BN3**



**R-KITPMHP3RS3**

**2x** **SPECIFIC MOUNTING KIT INCLUDED**



**€ 38.95**



**R-KITPMHP3GF3**



**R-KITPMHP3BL3**



Black - **R-KITPMHP3NR3**

**NEW**

**HONDA CRF 250 2022-2023 CRF 450 2021>2023**

**KAWASAKI KX 250 2021>2023 KX 450 2019>2023**

With specific **Nissin** nylon mounting kit on the levers - *Forniti con kit montaggio alle leve specifico per **Nissin***  
Only for Hydraulic clutch pump / *Solo per frizione idraulica*

**2x** **SPECIFIC MOUNTING KIT INCLUDED**



**€ 38.95**



White/Black - **R-KITPMHP3BN4**



**R-KITPMHP3RS4**



Black - **R-KITPMHP3NR4**



Black - **R-KITPMHP3VE4**

**> REPLACEMENT PARTS – RICAMBI PARAMANI**

**Replacement plastic shield - *Plastiche di ricambio***

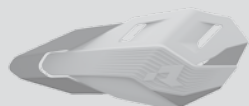

☀: fluorescent color

| COLOR               | CODE                 | PRICE   |
|---------------------|----------------------|---------|
| K Orange/Black      | <b>R-HP3REPARNR0</b> | € 24,95 |
| YZ Blue/White       | <b>R-HP3REPBNO</b>   | € 24,95 |
| White/Black         | <b>R-HP3REPBNNR0</b> | € 24,95 |
| RM Yellow/Black     | <b>R-HP3REPGINR0</b> | € 24,95 |
| Black/Neon yellow ☀ | <b>R-HP3REPNRGF0</b> | € 24,95 |
| Black/Neon orange ☀ | <b>R-HP3REPNRANO</b> | € 24,95 |
| Quantum grey/Black  | <b>R-HP3REPGRR0</b>  | € 24,95 |
| Black               | <b>R-HP3REPNR000</b> | € 24,95 |
| CR Red/White        | <b>R-HP3REPRSBNO</b> | € 24,95 |
| KX Green/Black      | <b>R-HP3REPVENR0</b> | € 24,95 |



Specific **Braketec** nylon mounting kit on the levers  
*Kit montaggio alle leve specifico **Braketec***

**R-KITSUPHP3NR**

**€ 16.95**

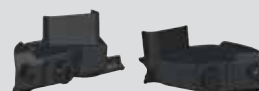

Specific **Kawasaki KX/Honda CRF** nylon mounting kit on the levers  
*Kit montaggio alle leve specifico **Kawasaki KX/Honda CRF***

**R-KITSUPHP4NR**

**€ 16.95**



## HANDGUARDS - PARAMANI HP3 ADVENTURE

- Made by a special technopolymer material, strong and flexible
  - Excellent protection, durability, lightness and stability also at high speed
  - Micrometric height adjustment of the removable polycarbonate transparent extra shield
  - Supplied by a strong technopolymer plastic bar
  - **Specific mounting kit for the most popular adventure/rally bikes sold separately**
- Realizzati in uno speciale tecnopolimero robusto e flessibile
  - Eccellente durata, leggerezza e stabilita' e anche alle alte velocita'
  - Spoiler in polycarbonato removibile regolabile micrometricamente in altezza
  - Fornito di robusta barra in tecnopolimero
  - **Kit di montaggio specifico per le piu' diffuse moto adventure/rally venduto separatamente**

€ 74.95

### > MOUNTING - CONFIGURATION 1

Specific mounting kit / *Kit di montaggio specifici*

BMW GS 1200/1250 - BMW GS 700/800 - HONDA AFRICA TWIN 1000/1100 - YAMAHA SUPERTENERE' 700/1200 - KTM ADV/DUCATI MULTISTRADA  
KIT NOT INCLUDED see pag. 202 / *KIT DI MONTAGGIO NON INCLUSO vedere a pag. 202*



### > MOUNTING - CONFIGURATION 2

ATV mounting kit / *Kit di montaggio ATV / ADVENTURE*

KIT NOT INCLUDED see pag. 175 / *KIT DI MONTAGGIO NON INCLUSO vedere a pag. 172*

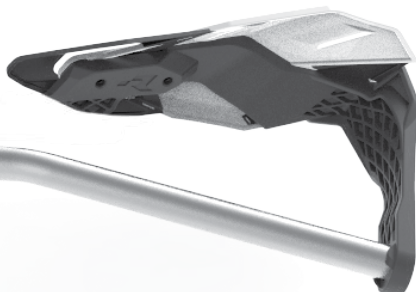

## Available colors - Colori disponibili



Black - **R-HP3ADVNR000**



White/Black - **R-HP3ADVBNNR0**



**NEON**

Black/ Neon Orange - **R-HP3ADVNRANO**



K Orange/Black - **R-HP3ADVARNR0**



KX Green/Black - **R-HP3ADVVENR0**



RM Yellow/Black - **R-HP3ADVGINR0**



**NEON**

Black/ Neon Yellow - **R-HP3ADVNRGFO**



CR Red/White - **R-HP3ADVRSBNO**



Quantum Grey/Black - **R-HP3ADVGRNR0**



YZ Blue/White - **R-HP3ADVBLBNO**

## > REPLACEMENT PARTS – RICAMBI PARAMANI

### Replacement plastic shield - *Plastiche di ricambio*



fluorescent color

| COLOR              | CODE                 | PRICE   |
|--------------------|----------------------|---------|
| K orange/Black     | <b>R-HP3REPARNR0</b> | € 24,95 |
| YZ Blue/White      | <b>R-HP3REPBLBNO</b> | € 24,95 |
| White/Black        | <b>R-HP3REPBNNR0</b> | € 24,95 |
| RM Yellow/Black    | <b>R-HP3REPGINR0</b> | € 24,95 |
| Black/Neon yellow  | <b>R-HP3REPNRGFO</b> | € 24,95 |
| Black/Neon orange  | <b>R-HP3REPNRANO</b> | € 24,95 |
| Quantum grey/Black | <b>R-HP3REPGRNR0</b> | € 24,95 |
| Black              | <b>R-HP3REPNR000</b> | € 24,95 |
| CR Red/White       | <b>R-HP3REPRSBN0</b> | € 24,95 |
| KX Green/Black     | <b>R-HP3REPVENR0</b> | € 24,95 |

### Replacement Mounting Kit - *Ricambi kit di montaggio*

Plastic Bar **BLACK** - Barra di montaggio **NERO**  
**R-REPBARRAHP3**

**€ 38.95**

Polycarbonate shield **LIGHT SMOKE** - Spoiler in policarbonato **TRASPARENTE**  
**R-REPSHIELHP3**

**€ 24.95**



# HANDGUARDS - PARAMANI FLX

Used by Pro Circuit Factory Team



## UNIVERSAL

Contains an universal bracket to the handlebar plus a specific mounting kit to the levers with specific screws for each motorcycle brand. Permanent IPL graphic co-injected

## UNIVERSALE

Contiene un kit di montaggio al manubrio universale ed un kit di montaggio alle leve specifico per ogni moto. Le decorazioni grafiche sono stampate in modo permanente e garantiscono brillantezza e durata nel tempo.



€ 43.95

2x **UNIVERSAL MOUNTING KIT INCLUDED**

Handlebar mounting kit - Kit montaggio al manubrio



Lever mounting kit - Kit montaggio alle leve



## CONFIGURABLE IN 4 DIFFERENT WAYS



LIGHT



STANDARD



MEDIUM



WINTER



Adjustable in 3 side position  
Regolabile lateralmente in 3 posizioni



Allows the rotation in case of impact  
Ruota in caso di caduta

## > MOUNTING - MONTAGGIO

Lever mounting kit  
Kit montaggio alle leve



Handlebar mounting kit  
Kit montaggio al manubrio

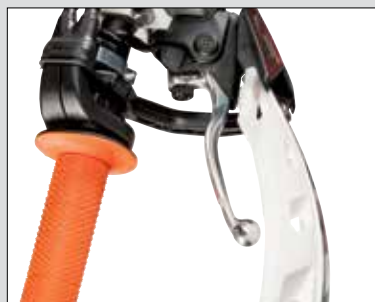

Available colors - Colori disponibili



CR Red - R-KITPMFLRS00



K Orange - R-KITPMFLAR00



Black - R-KITPMFLNR00



RM Yellow - R-KITPMFLGI00



KX Green - R-KITPMFLVE00



YZ Blue - R-KITPMFLBL00



NEON

Neon Yellow - R-KITPMFLGF00



NEON

Neon Orange - R-KITPMFLAN00



NEON

Neon Pink - R-KITPMFLFU00



White - R-KITPMFLBN00

> REPLACEMENT PARTS - RICAMBI PARAMANI

Replacement plastic shield - Plastiche di ricambio



☀ fluorescent color

| COLOR       | CODE            | PRICE   |
|-------------|-----------------|---------|
| K Orange K  | R-REPPMFLAR00   | € 24,95 |
| Neon Orange | ☀ R-REPPMFLAN00 | € 24,95 |
| YZ Blue     | R-REPPMFLBL00   | € 24,95 |
| White       | R-REPPMFLBN00   | € 24,95 |
| Neon Pink   | ☀ R-REPPMFLFU00 | € 24,95 |
| Neon Yellow | ☀ R-REPPMFLGF00 | € 24,95 |
| RM Yellow   | R-REPPMFLGI00   | € 24,95 |
| Black       | R-REPPMFLNR00   | € 24,95 |
| CR Red      | R-REPPMFLRS00   | € 24,95 |
| KX Green    | R-REPPMFLVE00   | € 24,95 |



€ 15.95

Handlebar mounting kit  
R-KITSUPVTNR0



€ 20.95

Lever mounting kit  
R-KITSUPFLXNR

OPTIONAL

Forged alloy handlebar mount kit

Kit di montaggio racing in alluminio forgiato anodizzato



R-KITSUPVTRS1



R-KITSUPVTAR1

€ 38.95



R-KITSUPVTAL1



R-KITSUPVTBL1



## HANDGUARDS - PARAMANI FLX ALU



### LIGHTWEIGHT, STRONG, MAX AIRFLOW

With aluminum bar and plastic side protection.  
Permanent IPL graphic co-injected

### OTTIMA RESISTENZA E VENTILAZIONE

Con barra di rinforzo in alluminio e slider in PP antiurto.  
Le decorazioni grafiche sono stampate in modo permanente e garantiscono brillantezza e durata nel tempo.

€ 74.95



\*Mounting kit NOT INCLUDED with FLX ALU.  
Recommended KITMOUNT003 or KITMOUNT005 - Mounting kit on pag. 48  
\*Kit di montaggio NON INCLUSO.  
Kit consigliato KITMOUNT003 o KITMOUNT005 - Kit di montaggio a pag. 48

### CONFIGURABLE IN 4 DIFFERENT WAYS



LIGHT



STANDARD



MEDIUM



WINTER

### > MOUNTING - MONTAGGIO



**Available colors - Colori disponibili**



CR Red - **R-KITPMFMRS00**



K Orange - **R-KITPMFMAR00**



Black - **R-KITPMFMNR00**



RM Yellow - **R-KITPMFMGI00**



KX Green - **R-KITPMFMVE00**



YZ Blue - **R-KITPMFMBL00**



**NEON**

Neon Yellow - **R-KITPMFMGF00**



**NEON**

Neon Orange - **R-KITPMFMAN00**



**NEON**

Neon Pink - **R-KITPMFMFU00**



White - **R-KITPMFMBN00**



**> REPLACEMENT PARTS - RICAMBI PARAMANI**

**Replacement plastic shield - Plastiche di ricambio**



fluorescent color

| COLOR       | CODE                 | PRICE   |
|-------------|----------------------|---------|
| K Orange    | <b>R-REPPMFLAR00</b> | € 24,95 |
| Neon Orange | <b>R-REPPMFLAN00</b> | € 24,95 |
| YZ Blue     | <b>R-REPPMFLBL00</b> | € 24,95 |
| White       | <b>R-REPPMFLBN00</b> | € 24,95 |
| Neon Pink   | <b>R-REPPMFLFU00</b> | € 24,95 |
| Neon Yellow | <b>R-REPPMFLGF00</b> | € 24,95 |
| RM Yellow   | <b>R-REPPMFLGI00</b> | € 24,95 |
| Black       | <b>R-REPPMFLNR00</b> | € 24,95 |
| CR Red      | <b>R-REPPMFLRS00</b> | € 24,95 |
| KX Green    | <b>R-REPPMFLVE00</b> | € 24,95 |



**€ 13.95**

Handguards slider - *Slider*  
**R-REPSLVTNR00**



**€ 44.95**

Aluminum reinforcing bar  
**R-REPALUSM018**

## HANDGUARDS FOR ATV'S IDEATI PER QUAD/ATV



€ 89.95



**UNIVERSAL MOUNTING KIT INCLUDED**

Steel galvanized expanders for handlebars with inner hole  
*Espansori in acciaio zincato per manubri in acciaio con foro interno*



ø 14-18 mm



ø 16-17 mm



ø 18-20,5 mm

### CONFIGURABLE IN 4 DIFFERENT WAYS



LIGHT



STANDARD



MEDIUM



WINTER

### > MOUNTING - MONTAGGIO

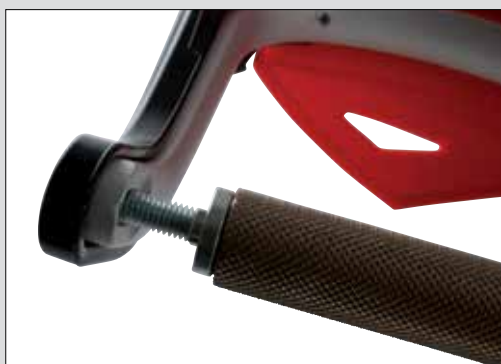

New "double expanders" mounting kit for handlebars with hole ø14mm or ø18mm. The special fitting system avoids the rotation of the handguards. Spare mounting kit available in the "mounting kit hand guards" on page 48

*Dettaglio del fissaggio del kit di montaggio FLX e VERTIGO ATV con "double expanders" universali per tutti i manubri. Lo speciale fissaggio ad incastro evita la rotazione del paramani. Ricambi ed accessori a pag. 48*

**Available colors - Colori disponibili**



CR Red - **R-KITPMATVRSF**



K Orange - **R-KITPMATVARF**



Black - **R-KITPMATVNR**



RM Yellow - **R-KITPMATVGIF**



KX Green - **R-KITPMATVVEF**



YZ Blue - **R-KITPMATVBLF**



Neon Yellow - **R-KITPMATVGFF**



Neon Orange - **R-KITPMATVANF**



Neon Pink - **R-KITPMATVFUF**



White - **R-KITPMATVBNF**

**> REPLACEMENT PARTS - RICAMBI PARAMANI**

**Replacement plastic shield - Plastiche di ricambio**



☀ fluorescent color

| COLOR       | CODE            | PRICE   |
|-------------|-----------------|---------|
| K Orange K  | R-REPPMFLAR00   | € 24,95 |
| Neon Orange | ☀ R-REPPMFLAN00 | € 24,95 |
| YZ Blue     | R-REPPMFLBL00   | € 24,95 |
| White       | R-REPPMFLBN00   | € 24,95 |
| Neon Pink   | ☀ R-REPPMFLFU00 | € 24,95 |
| Neon Yellow | ☀ R-REPPMFLGF00 | € 24,95 |
| RM Yellow   | R-REPPMFLGI00   | € 24,95 |
| Black       | R-REPPMFLNR00   | € 24,95 |
| CR Red      | R-REPPMFLRS00   | € 24,95 |
| KX Green    | R-REPPMFLVE00   | € 24,95 |



€ 13.95

Handguards slider - Slider  
**R-REPSLVTNR00**



€ 44.95

Aluminum reinforcing bar  
**R-REPALUSM018**





## USED BY TOP TEAMS

Characterized by an attractive and modern design, supplied with mounting kit from independent levers, adjustable height and sideways. Permanent IPL graphic co-injected

## UTILIZZATO DAI TOP TEAM

*Caratterizzato da un design moderno ed accattivante, fornito con kit di montaggio indipendente dalle leve, regolabile in altezza e lateralmente.*

*Il sistema di fissaggio permette la rotazione in caso di caduta.*

*Disponibili in opzione kit di fissaggio in alluminio forgiato e kit di montaggio alle leve.*

*Le decorazioni grafiche sono stampate in modo permanente e garantiscono brillantezza e durata nel tempo.*



€ 32.95

**HANDLEBAR MOUNTING KIT INCLUDED**



Handlebar mounting kit - Kit montaggio al manubrio



Adjustable in 3 side position  
Regolabile lateralmente in 3 posizioni



Allows the rotation in case of impact  
Ruota in caso di caduta

## > MOUNTING - MONTAGGIO



Standard handlebar bracket - Montaggio standard



Inverted handlebar bracket - Montaggio invertito

Available colors - Colori disponibili



CR Red - R-KITPMVTRS00



K Orange - R-KITPMVTAR00



Black - R-KITPMVTNR00



White - R-KITPMVTBN00



KX Green - R-KITPMVTE00



YZ Blue - R-KITPMVTBL00



RM Yellow - R-KITPMVTGI00



Neon Orange - R-KITPMVTAN00



Neon Yellow - R-KITPMVTGF00



OPTIONAL

Forged alloy handlebar mount kit  
Kit di montaggio racing in alluminio forgiato anodizzato



R-KITSUPVTRS1



R-KITSUPVTAR1

€ 38.95



R-KITSUPVTAL1



R-KITSUPVTBL1

Lever mount kit / Kit di montaggio alle leve



€ 20.95

Lever mounting kit  
R-KITSUPFLXNR

> REPLACEMENT PARTS - RICAMBI PARAMANI

Replacement plastic shield - Plastiche di ricambio



💡 fluorescent color

| COLOR       | CODE           | PRICE   |
|-------------|----------------|---------|
| K Orange    | R-REPPMTAR00   | € 20,95 |
| Neon Orange | 💡 R-REPPMTAN00 | € 20,95 |
| YZ Blue     | R-REPPMTBL00   | € 20,95 |
| White       | R-REPPMTBN00   | € 20,95 |
| Neon Yellow | R-REPPMTGF00   | € 20,95 |
| RM Yellow   | R-REPPMTGI00   | € 20,95 |
| Black       | R-REPPMTNR00   | € 20,95 |
| CR Red      | R-REPPMVTRS00  | € 20,95 |
| KX Green    | R-REPPMTE00    | € 20,95 |



€ 15.95

Handlebar mounting kit  
R-KITSUPVTNR0

# HANDGUARDS - PARAMANI VERTIGO ALU



## ESSENTIAL AND HIGH RESISTANT

Supplied with alu reinforcing bar and slider of shock resistant polyurethane in order to protect the bar in case of fall. Permanent IPL graphic co-injected.

## PARAMANI LINEA MINIMAL

Barra di rinforzo in alluminio ed esclusivo slider in poliuretano antiurto a protezione della stessa in caso di caduta. Le decorazioni grafiche sono stampate in modo permanente e garantiscono brillantezza e durata nel tempo.



€ 71.95

\*Mounting kit NOT INCLUDED with VERTIGO ALU.  
Recommended KITMOUNT003 or KITMOUNT005 - Mounting kit on pag. 48  
\*Kit di montaggio NON INCLUSO.  
Kit consigliato KITMOUNT003 o KITMOUNT005 - Kit di montaggio a pag. 48



## Available colors - Colori disponibili



CR Red - R-KITPMVMRS00



K Orange - R-KITPMVMAR00



Black - R-KITPMVMNR00



White - R-KITPMVMBN00



KX Green - R-KITPMVMVE00



YZ Blue - R-KITPMVMBL00



RM Yellow - R-KITPMVMGI00



Neon Orange - R-KITPMVMAN00



Neon Yellow - R-KITPMVMGF00

## > REPLACEMENT PARTS - RICAMBI PARAMANI

### Replacement plastic shield - Plastiche di ricambio

| COLOR       | CODE          | PRICE   |
|-------------|---------------|---------|
| K Orange    | R-REPPMVTAR00 | € 20,95 |
| Neon Orange | R-REPPMVTAN00 | € 20,95 |
| YZ Blue     | R-REPPMVTBL00 | € 20,95 |
| White       | R-REPPMVTBN00 | € 20,95 |
| Neon Yellow | R-REPPMVTGF00 | € 20,95 |
| RM Yellow   | R-REPPMVTGI00 | € 20,95 |
| Black       | R-REPPMVTNR00 | € 20,95 |
| CR Red      | R-REPPMVTRS00 | € 20,95 |
| KX Green    | R-REPPMVTVE00 | € 20,95 |

fluorescent color



€ 13.95

Handguards slider - Slider  
R-REPSLVTNR00



€ 44.95

Aluminum reinforcing bar  
R-REPALUSM018



## HANDGUARDS FOR ATV'S IDEATI PER QUAD/ATV



€ 79.95



Steel galvanized expanders for handlebars with inner hole  
Espansori in acciaio zincato per manubri in acciaio con foro interno



ø 14-18 mm



ø 16-17 mm



ø 18-20,5 mm



### Available colors - Colori disponibili



CR Red - R-KITPMATVRSO



K Orange - R-KITPMATVARO



Black - R-KITPMATVNRO



White - R-KITPMATVBNO



KX Green - R-KITPMATVVEO



YZ Blue - R-KITPMATVBLO



RM Yellow - R-KITPMATVGIO





Neon Orange - R-KITPMATVANO 



Neon Yellow - R-KITPMATVGF0 

## > REPLACEMENT PARTS - RICAMBI PARAMANI

 fluorescent color

| COLOR   | CODE          | PRICE   |
|---|---------------|---------|
| K Orange  | R-REPPMVTAR00 | € 20,95 |
| Neon Orange  | R-REPPMVTAN00 | € 20,95 |
| YZ Blue   | R-REPPMVTBLO0 | € 20,95 |
| White   | R-REPPMVTBN00 | € 20,95 |
| Neon Yellow  | R-REPPMVTGF00 | € 20,95 |
| RM Yellow   | R-REPPMVTGIO0 | € 20,95 |
| Black   | R-REPPMVTNR00 | € 20,95 |
| CR Red  | R-REPPMVTRS00 | € 20,95 |
| KX Green  | R-REPPMVTVE00 | € 20,95 |

### Replacement plastic shield Plastiche di ricambio



€ 13.95

Handguards slider - Slider  
R-REPSLVNRO0

# HANDGUARDS - PARAMANI GLADIATOR EASY

EASY TO INSTALL, LIGHTWEIGHT, WINNING DESIGN  
LINEA ACCATTIVANTE, ESTREMA LEGGEREZZA



€ 49.95

**STANDARD MOUNTING KIT INCLUDED**



Includes standard mounting kit for 22 mm (7/8") and 28mm (1-1/8") handlebars  
*Kit di montaggio standard incluso per manubri ø28 e ø22*

**OPTIONAL** - Mounting Kit KITMOUNT003 or KITMOUNT005  
Mounting kit on pag. 48 - *Kit di montaggio a pag. 48*



## Available colors - Colori disponibili



RM Yellow - R-KITPMGLI08



K Orange - R-KITPMGLAR08



White - R-KITPMGLBN08



KX Green - R-KITPMGLVE08



Black - R-KITPMGLNR08



CR Red - R-KITPMGLRS08



Neon Yellow - R-KITPMGLGF08



YZ Blue - R-KITPMGLBL08

## > REPLACEMENT PARTS - RICAMBI PARAMANI

### Replacement plastic shield - Plastiche di ricambio

| COLOR       | CODE          | PRICE   |
|-------------|---------------|---------|
| K Orange    | R-REPPMGLAR00 | € 27,95 |
| YZ Blue     | R-REPPMGLBL00 | € 27,95 |
| White       | R-REPPMGLBN00 | € 27,95 |
| Neon Yellow | R-REPPMGLGF00 | € 27,95 |
| RM Yellow   | R-REPPMGLGI00 | € 27,95 |
| Black       | R-REPPMGLNR00 | € 27,95 |
| CR Red      | R-REPPMGLRS00 | € 27,95 |
| KX Green    | R-REPPMGLVE00 | € 27,95 |

fluorescent color





## SUPER TOUGH AND LIGHTWEIGHT DESIGN

Maximum strenght thanks to the reinforcing aluminum bar, co-injected IPL permanent graphics allow shining and durable. Permanent IPL graphic co-injected

## LINEA ACCATTIVANTE MASSIMA RESISTENZA

Grazie alla barra di rinforzo in alluminio trafilato e temprato.

Le decorazioni grafiche sono stampate in modo permanente e garantiscono brillantezza e durata nel tempo.



€ 69.95

\*Mounting kit NOT INCLUDED  
Recommended KITMOUNT003 or KITMOUNT005 - Mounting kit on pag. 48  
\*Kit di montaggio NON INCLUSO.  
Kit consigliato KITMOUNT003 o KITMOUNT005 - Kit di montaggio a pag. 48



RM Yellow - R-KITPMGLGIR9



K Orange - R-KITPMGLARR9



Black - R-KITPMGLNRR9



White - R-KITPMGLBNR9



KX Green - R-KITPMGLVER9



YZ Blue - R-KITPMGLBLR9



CR Red - R-KITPMGLRSR9



Neon Yellow - R-KITPMGLGFR9

## > REPLACEMENT PARTS - RICAMBI PARAMANI

### Replacement plastic shield - Plastiche di ricambio

| COLOR       | CODE          | PRICE   |
|-------------|---------------|---------|
| K Orange    | R-REPPMGLAR00 | € 27,95 |
| YZ Blue     | R-REPPMGLBL00 | € 27,95 |
| White       | R-REPPMGLBN00 | € 27,95 |
| Neon Yellow | R-REPPMGLGF00 | € 27,95 |
| RM Yellow   | R-REPPMGLGI00 | € 27,95 |
| Black       | R-REPPMGLNR00 | € 27,95 |
| CR Red      | R-REPPMGLRS00 | € 27,95 |
| KX Green    | R-REPPMGLVE00 | € 27,95 |

💡 fluorescent color



€ 44.95

Aluminum reinforcing bar  
R-REPALUSM009



## WORLD CHAMPIONS ENDURO 2016-17-18-19

### STEVE HOLCOMBE Team BETA FACTORY

New dual handguards with bracket for handlebar shared with Vertigo and FLX models.  
Can be fitted and adjusted independently from the levers. Are provided with universal nylon connections.  
Available as an option forged aluminum mounting kits and nylon Mounting kit to the levers.  
Permanent IPL graphic co-injected

## I PARAMANI CAMPIONI DEL MONDO ENDURO 2016-17-18-19

### STEVE HOLCOMBE Team BETA FACTORY

Con supporto al manubrio in comune ai modelli Vertigo ed Flx.  
Può essere montato e regolato indipendentemente dalle leve. Fornito di attacchi universali.  
Disponibili come accessori i kit di fissaggio in alluminio forgiato e kit di montaggio alle leve.  
Le decorazioni grafiche sono stampate in modo permanente e garantiscono brillantezza e durata nel tempo.



€ 32.95

Handlebar mounting kit  
Kit montaggio al manubrio



Adjustable in 3 side position  
Regolabile lateralmente in 3 posizioni

Allows the rotation in case of impact  
Ruota in caso di caduta

## > MOUNTING – MONTAGGIO



Available colors - Colori disponibili



CR Red - R-KITPMDURS14



K Orange - R-KITPMDUAR14



Black - R-KITPMDUNR14



White - R-KITPMDUBN14



RM Yellow - R-KITPMDUGI14



YZ Blue - R-KITPMDUBL14



KX Green - R-KITPMDUVE14



Neon Yellow - R-KITPMDUGF14



OPTIONAL

Forged alloy handlebar mount kit  
Kit di montaggio racing in alluminio forgiato anodizzato



R-KITSUPVTRS1



R-KITSUPVTAR1



R-KITSUPVTAL1



R-KITSUPVTBL1

€ 38.95

Lever mount kit / Kit di montaggio alle leve



€ 20.95

> REPLACEMENT PARTS - RICAMBI PARAMANI

Replacement plastic shield - Plastiche di ricambio



💡 fluorescent color

| COLOR       | CODE            | PRICE   |
|-------------|-----------------|---------|
| K Orange    | R-REPPMDUAR14   | € 20,95 |
| YZ Blue     | R-REPPMDUBL14   | € 20,95 |
| White       | R-REPPMDUBN14   | € 20,95 |
| Neon Yellow | 💡 R-REPPMDUGF14 | € 20,95 |
| RM Yellow   | R-REPPMDUGI14   | € 20,95 |
| Black       | R-REPPMDUNR14   | € 20,95 |
| CR Red      | R-REPPMDURS14   | € 20,95 |
| KX Green    | R-REPPMDUVE14   | € 20,95 |



€ 15.95

Handlebar mounting kit  
R-KITSUPVTNRO

# HANDGUARDS - PARAMANI RAPTOR

## MAXIMUM STRENGTH AND LIGHTNESS

Protective, with a slender design, extremely light and high resistant to suit the new modern supermotard and rally trends. Permanent IPL graphic co-injected. Supermoto world champion!

## MASSIMA RESISTENZA ED OTTIMA LEGGEREZZA

Protettivi dalla linea filante per seguire le nuove tendenze del supermotard e rally. Paramani pluri campione del mondo Supermoto. Le decorazioni grafiche sono stampate in modo permanente e garantiscono brillantezza e durata nel tempo.

€ 54.95



CR Red - R-KITPMRPRS00



K Orange - R-KITPMRPAR00



Black - R-KITPMRPNR00



White - R-KITPMRPNB00



KX Green - R-KITPMRPVE00



YZ Blue - R-KITPMRPNB00



RM Yellow - R-KITPMRPGI00



Neon Orange - R-KITPMRPNR00



Neon Yellow - R-KITPMRPGF00



### OPTIONAL

Mounting Kit KITMOUNT003 or KITMOUNT005

Mounting kit on pag. 48 - Kit di montaggio a pag. 48

Includes standard mounting kit For 22 mm (7/8") and 28mm (1-1/8") handlebars  
Kit di montaggio standard incluso per manubri ø28 e ø22



## > MOUNTING - MONTAGGIO



NYLON HYDRAULIC PUMPS GUARD SPECIFIC FOR **BRAKTEC**  
GASGAS EC/ECF 2021>2023 | HUSQVARNA TE/FE 2020>2023



**€ 16.95**  
R-PRTPUMPNR01

NYLON HYDRAULIC PUMPS GUARD SPECIFIC **NISSIN**  
HONDA CRF 250 2022-2023 CRF 450 2021>2023  
KAWASAKI KX 250 2021>2023 KX 450 2019>2023



**€ 16.95**  
R-PRTPUMPNR02



## HP3 MOUNTING KIT

€ 43.95



**R-KITMOUNTGS1**  
SPECIFIC MOUNTING KIT  
**BMW GS**  
1200/1250  
HANDLEBAR :22 > 28

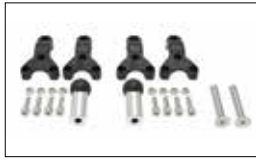

**R-KITMOUNTGS8**  
SPECIFIC MOUNTING KIT  
**BMW GS**  
700/800  
HANDLEBAR :22 > 28



**R-KITMOUNTAFR**  
SPECIFIC MOUNTING KIT  
**HONDA AFRICA TWIN**  
1000/1100  
HANDLEBAR :22 > 28

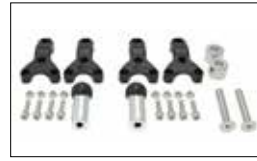

**R-KITMOUNTXTZ**  
SPECIFIC MOUNTING KIT  
**YAMAHA**  
SUPERTENERE' 700/1200  
HANDLEBAR :22 > 28

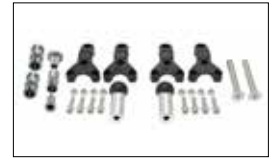

**R-KITMOUNTADV**  
SPECIFIC MOUNTING KIT  
**KTM ADV**  
**DUCATI MULTISTRADA**  
HANDLEBAR :22 > 28



**SPHERIC MOUNTING KIT**  
Adjustable plastic/alloy mounting kit.  
Universal for handlebars  
ø28mm (1-1/8") > ø22mm (7/8")  
included 14/16/18 mm steel expanders

*Kit di montaggio "sferico"  
in plastica/alluminio.  
Universale per manubri Ø28 > Ø22 mm  
Inclusi espansori da 14/16/18 mm*



**R-KITMOUNT006** € 43.95



**ADJUSTABLE MOUNTING KIT**  
Adjustable forged alloy mounting kit.  
Universal for any diameter handlebars  
thanks to the new nylon reductions  
ø28mm (1-1/8") > ø22mm (7/8")

*Kit di montaggio "snodato" in alluminio  
forgiato. Universale per manubri di  
qualsiasi diametro grazie alle riduzioni in  
nylon Ø28 > Ø22 mm*



**R-KITMOUNT003** € 52.95



Detail cable rout

**MOUNTING KIT**  
Solid forged alloy mounting kit.  
Universal for any diameter handlebars  
thanks to the new nylon reductions  
ø28mm (1-1/8") > ø22mm (7/8")

*Kit di montaggio "fisso" in alluminio  
forgiato. Universale per manubri  
di qualsiasi diametro grazie alle nuove  
riduzioni in nylon Ø28 > Ø22 mm*



**R-KITMOUNT005** € 52.95

**MOUNTING KIT**  
Nylon mounting kit for Gladiator.  
For ø22mm (7/8") or ø28mm (1-1/8")  
diameter handlebars.

*Kit montaggio snodato in plastica.  
Universale per manubri  
di diametro Ø22 e Ø28 mm*



**R-KITMOUNT014** € 27.95

### PAIR OF M8 SPACERS MADE BY STEEL GALVANIZED FOR NON JOINTED MOUNTING KIT COPPIA DISTANZIALI M8 PER KIT DI MONTAGGIO SNODATI IN ALLUMINIO ANODIZZATO



Spacer 40mm  
**R-DSPMSMM8L40**

€ 15.95



Spacer 65mm  
**R-DSPMSMM8L65**

€ 15.95



Spacer 30mm  
**R-DSPMSMRAC30**

€ 12.95

### DOUBLE EXPANDER



Allows an exponential increase in the force of the knurled surface to the handlebar for non-slip mounting.  
\* Patent national and international required.

*Consente un incremento esponenziale della forza di ancoraggio, la superficie zigrinata è COMPLETAMENTE a contatto con il manubrio.*















*\*Brevetti nazionali ed internazionali richiesti.*













### TRADITIONAL EXPANDER



Only a small part of the knurled surface has a direct contact with the inner of the handlebar.

*Solo una piccola porzione della superficie zigrinata è a diretto contatto con il manubrio.*

| HANDLEBAR EXPANDERS / ESPANSORI MANUBRIO  |  |  |  |   |  |  |
|---|--|--|--|---|--|--|
| <b>MOTARD / RALLY</b>   |  |  |  |   |  |  |
| <b>€ 19.95</b>  |  |  |  |   |  |  |
|   |   |   |   |   |   |   |
|   | <b>HP3</b>   | <b>FLX ALU</b>   | <b>VERTIGO ALU</b>   | <b>GLADIATOR</b>  | <b>GLADIATOR ALU</b>   | <b>RAPTOR</b>  |
| Handlebars inner hole<br><i>Manubri con foro interno</i><br><b>Ø 14-15,5 mm</b> | <br>Expanders mounting kit<br><b>R-KITEXP014AC</b>  | <br>Expanders mounting kit<br><b>R-KITEXP014AC</b>  | <br>Expanders mounting kit<br><b>R-KITEXP014AC</b>  | <br>Expanders mounting kit<br><b>R-KITEXP014AC</b>  | <br>Expanders mounting kit<br><b>R-KITEXP014AC</b>  | <br>Expanders mounting kit<br><b>R-KITEXP014AC</b>  |
| Handlebars inner hole<br><i>Manubri con foro interno</i><br><b>Ø 16-17,5 mm</b> | <br>Expanders mounting kit<br><b>R-KITEXP016AC</b>  | <br>Expanders mounting kit<br><b>R-KITEXP016AC</b>  | <br>Expanders mounting kit<br><b>R-KITEXP016AC</b>  | <br>Expanders mounting kit<br><b>R-KITEXP016AC</b>  | <br>Expanders mounting kit<br><b>R-KITEXP016AC</b>  | <br>Expanders mounting kit<br><b>R-KITEXP016AC</b>  |
| Handlebars inner hole<br><i>Manubri con foro interno</i><br><b>Ø 18-20,5 mm</b> | <br>Expanders mounting kit<br><b>R-KITEXP018AC</b> | <br>Expanders mounting kit<br><b>R-KITEXP018AC</b> | <br>Expanders mounting kit<br><b>R-KITEXP018AC</b> | <br>Expanders mounting kit<br><b>R-KITEXP018AC</b> | <br>Expanders mounting kit<br><b>R-KITEXP018AC</b> | <br>Expanders mounting kit<br><b>R-KITEXP018AC</b> |

| HANDLEBAR EXPANDERS / ESPANSORI MANUBRIO  |   |  |   |
|---|---|--|---|
| <b>ATV</b>  |   |  |   |
| <b>€ 19.95</b>  |   |  |   |
|   |    |    |    |
|   | <b>HP1 SCRAMBLER</b>  | <b>FLX ATV</b>   | <b>VERTIGO ATV</b>  |
| Handlebars inner hole<br><i>Manubri con foro interno</i><br><b>Ø 14-15,5 mm</b> | <br>Expanders mounting kit<br><b>R-KITEXP14ATV</b> | <br>Expanders mounting kit<br><b>R-KITEXP14ATV</b> | <br>Expanders mounting kit<br><b>R-KITEXP14ATV</b> |
| Handlebars inner hole<br><i>Manubri con foro interno</i><br><b>Ø 16-17,5 mm</b> | <br>Expanders mounting kit<br><b>R-KITEXP16ATV</b> | <br>Expanders mounting kit<br><b>R-KITEXP16ATV</b> | <br>Expanders mounting kit<br><b>R-KITEXP16ATV</b> |
| Handlebars inner hole<br><i>Manubri con foro interno</i><br><b>Ø 18-20,5 mm</b> | <br>Expanders mounting kit<br><b>R-KITEXP18ATV</b> | <br>Expanders mounting kit<br><b>R-KITEXP18ATV</b> | <br>Expanders mounting kit<br><b>R-KITEXP18ATV</b> |

**R20**

LOCK-ON GRIPS



**WAVE DESIGN**



**HALF WAFFLE DESIGN**

## GRIPS - MANOPOLE R20 LOCK-ON

- Easily installation thanks to the Lock-On System
  - 100% guaranteed slip-free performance under any condition
  - Diameter  $\varnothing 28.5\text{mm}$  for maximum ride feeling, throttle tube included with multi regulation point adjustment
  - Stainless bolt on alminum lock side
  - 8 different throttle cams included for all the most popular off-road bikes
- 3 specific throttle cams for Beta models:**
- one for 2 stroke, one replica as original 4 stroke
  - one for 4 stroke with quicker response especially in the first phase of acceleration

- Facile installazione grazie al sistema Lock-On
  - 100% antiscivolo in ogni condizione
  - Diametro  $\varnothing 28.5\text{mm}$ , massima sensibilità! Regolabile in più posizioni
  - Vite in acciaio inossidabile
  - 8 diverse camme, per adattarsi alla maggior parte delle moto
- 3 camme specifiche per modelli Beta:**
- una per 2 tempi, una replica dell'originale 4 tempi
  - una per 4 tempi con più rapida risposta del gas nella prima parte di accelerazione

€ 27.95

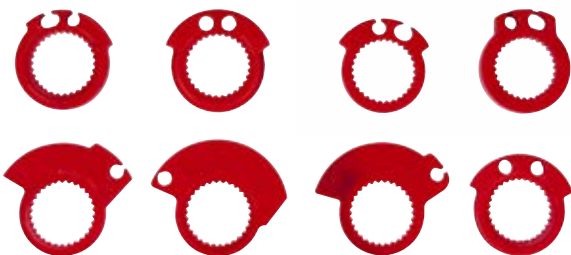

**8 different throttle cams included**  
**8 diverse camme incluse**

# GRIPS - MANOPOLE R20 LOCK-ON WAVE DESIGN



Blue  
R-MPRBL000020



Neon Yellow  
R-MPRGF000020



Neon Red  
R-MPRRF000020



Neon Orange  
R-MPRAN000020



Neon Green  
R-MPRVF000020



Grey  
R-MPRGR000020



Black  
R-MPRNR000020

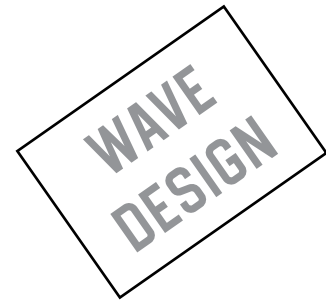

Neon Red  
R-MPRRFBETA20



Black  
R-MPRNRBETA20



Grey  
R-MPRGRBETA20

For BETA RR 125 > 530 with 3 specific throttle cams / con 3 camme specifiche

# R20 LOCK-ON CLASSIC HALF WAFFLE DESIGN



Blue  
R-MPRBL000021



Neon Yellow  
R-MPRGF000021



Neon Red  
R-MPRRF000021



Neon Orange  
R-MPRAN000021



Grey  
R-MPRGR000021



Neon Green  
R-MPRVF000021



Black  
R-MPRNR000021

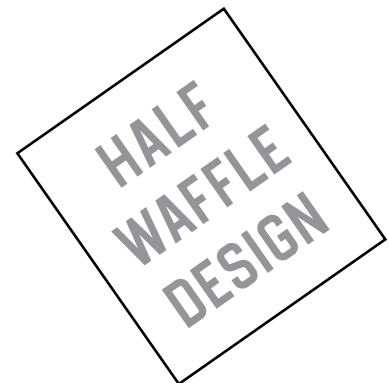

Grey  
R-MPRGRBETA21



Black  
R-MPRNRBETA21



Neon Red  
R-MPRRFBETA21

For BETA RR 125 > 530 with 3 specific throttle cams / con 3 camme specifiche

**ERGONOMIC DESIGN DEVELOPED ON YOUR HAND**

**Newest generation of grips** made of a special heat-sensitive material, designed to satisfy exactly the shape of the hand.

**Extra slim** thick for a better grip.

Ergonomically designed to reduce hand and arm fatigue.

End plate reinforced to prevent tearing during a fall.

**Super soft** to ensure comfort and grip like never before.

Side lange universal gas suitable for all motorcycles, length 116mm.

€ 11.95



**THE UNIQUE HELICOIDALLY DESIGNED OF LOWER PATTERN  
ALLOWS A BETTER GRIP WITH THE FINGER TIPS**

Diamond knurled helicoidally designed to avoid mud and dust with pyramids of varying size.

Smaller at the palm of your hand and the largest in the rest with your fingers.



**DESIGN ERGONOMICO SVILUPPATO SULLA TUA MANO**

*Nuovissima generazione di manopole, realizzate in uno speciale materiale termosensibile, studiate per assecondare esattamente la forma della mano.*

*Spessore extra slim per una presa migliore.*

*Design ergonomico studiato per ridurre l'affaticamento della mano e delle braccia.*

*Fondello rinforzato per evitare lacerazioni in caso di caduta.*

*Mescola super soft per assicurare confort e grip mai raggiunti finora.*

*Flangia lato gas universale adatta a tutte le moto, lunghezza 116mm.*

**L' ESCLUSIVO SVILUPPO ELICOIDALE DEL RETICOLO INFERIORE  
PERMETTE UNA MIGLIORE PRESA CON I POLPASTRELLI DELLE DITA.**

Zigrinatura diamantata a sviluppo elicoidale per scaricare al meglio fango e polvere con piramidi di dimensioni variabili.

Più piccole in corrispondenza del palmo della mano e più grandi nella zona di appoggio con le dita.



Side lange universal gas  
suitable for all motorcycles

Flangia universale lato comando gas  
Adatta a tutti i modelli di moto

> AVAILABLE IN 8 DIFFERENT COLORS



Blue  
R-MPRWAVEBL015



Yellow  
R-MPRWAVEGI015



Red  
R-MPRWAVERS015



Neon Yellow  
R-MPRWAVEGF015



Black  
R-MPRWAVENR015



Grey  
R-MPRWAVEGR015



Green  
R-MPRWAVEVE015



Orange  
R-MPRWAVEAR015



Blue  
R-MPR000BL014

€ 10.95



STEVE HOLCOMBE - Team Beta Factory



Side large universal gas  
suitable for all motorcycles

*Nuova flangia universale  
lato comando gas  
Adatta a tutti i modelli di moto*

**PROFESSIONAL OFF-ROAD HAND GRIPS**

Made exclusively for the most discerning riders of a special top quality thermosensitive material, designed for efficiency in the widest racing conditions of use. They also assure a perfect grip for the hands, damping vibrations thanks to the differentiated thicknesses.

**MANOPOLE OFF-ROAD PROFESSIONALI  
CAMPIONI DEL MONDO ENDURO 16-17-18-19-20  
STEVE HOLCOMBE Team BETA FACTORY**

*Realizzate in uno speciale materiale termosensibile di primissima scelta, con un design efficace nelle più svariate condizioni di utilizzo. Garantiscono inoltre una perfetta aderenza alla mano, smorzando le vibrazioni grazie agli spessori differenziati in corrispondenza dell'appoggio con il palmo della mano. Disponibili in un'unica versione con flangia comando gas universale adatta a tutte le moto. Lunghezza 115mm.*

**> AVAILABLE IN 7 DIFFERENT COLORS – DISPONIBILE IN 7 DIVERSI COLORI**



Yellow  
R-MPR000GI014



Orange  
R-MPR000AR014



Red  
R-MPR000RS014



Grey  
R-MPR000GR014



Black  
R-MPR000NR014



Green  
R-MPR000VE014



Orange-Black  
R-MPRNRAR0015

€ 15.95



**PROFESSIONAL OFF-ROAD  
HAND GRIPS DUAL COMPOUND**

Made exclusively for the most discerning riders of a special top quality thermosensitive material, designed for efficiency in the widest racing conditions of use. Thanks to the double layer, they also assure a perfect grip for the hands, damping vibrations thanks to the differentiated thicknesses.

**MANOPOLE OFF-ROAD DOPPIA MESCOLO**

*La mescola interna piu rigida assicura un migliore fissaggio al manubrio ed una maggiore resistenza alle lacerazioni del fondello in caso di caduta. La mescola esterna piu morbida ed a spessore differenziato permette un miglior grip ed un efficace riduzione delle vibrazioni trasmesse alla mano del pilota. Il design è concepito per essere efficace nelle più svariate condizioni di utilizzo. Disponibili in un unica versione con flangia comando gas universale adatta a tutte le moto.*



Side lange universal gas  
suitable for all motorcycles

Nuova flangia universale  
lato comando gas

**> AVAILABLE IN 6 DIFFERENT COLORS – DISPONIBILE IN 6 DIVERSI COLORI**



Red-Grey  
R-MPRGRRS0015



Yellow-Black  
R-MPRNRGI0015



Green-Black  
R-MPRNRVE0015



Black-Grey  
R-MPRGRNR0015



Blue-Grey  
R-MPRGRBL0015

## GRIPS – MANOPOLE FULL DIAMOND



€ 15.95

Red-Grey  
R-MPRGRRS0011



### FOR RIDING IN MUDDY AND DIFFICULT CONDITIONS

Dual-Compound grips reduce vibrations based on distinctive layer thickness. Proprietary heat sensitive material is designed for the most discriminating rider. Diamond grip area provides unsurpassed grip contact area for the widest range of riding conditions.

### MANOPOLE OFF-ROAD IDEALI PER L'IMPIEGO NEL FANGO

*Il design della speciale piramidatura e la miscela termosensibile molto morbida garantiscono un eccellente smorzamento delle vibrazioni assicurando un grip eccezionale. Studiate per ridurre al minimo diametro e spessori ed aumentare la capacità di presa sul manubrio da parte del pilota. Sono realizzate internamente con un componente più rigido che ne facilita il montaggio. Il grip elevato scongiura problemi di scivolamento durante la guida.*

### > AVAILABLE IN 4 DIFFERENT COLORS – DISPONIBILE IN 4 DIVERSI COLORI



Blue-Grey R-MPRGRBL0011



Red-Grey  
R-MPRGRRS0011



Black-Grey  
R-MPRGRNR0011



Red-Black R-MPRNRAR0011



€ 9.95

R-tech grips cover  
 Coprimanopola Rtech  
**R-CMRACNR0000**  
 (grips not included / manopole non incluse)



Neoprene grip donuts anti-blister  
 Rondelle antivesciche in neoprene  
**R-GRIPDONUNR1**  
 (grips not included / manopole non incluse)

€ 7.95



Wire zinc coil 30 mt x 0,8 mm  
 Rotolo filo 30 mt x 0,8 mm  
**R-FILOZINC010**

€ 9.95



€ 49.95

Wire pliers - black color  
 Pinza girafilo - colore nero  
**R-PINZAFILO01**







## HEADLIGHTS

*V-Face >pag 60*

*V-Face Led >pag 61*

*V-Face Full Led >pag 62*

*Genesis >pag 64*

*Matrix >pag 65*

*Replacement parts >pag 66*

*LED R3000 light kit >pag 68*

## TAIL-LIGHT

*Integra - Euro version >pag 70*

*Integra - USA version >pag 72*

*Integra - KTM >pag 73*

*Integra - HUSQVARNA >pag 74*

*Integra - BETA >pag 75*

*Integra - GAS GAS >pag 756*

*Replacement parts >pag 76*

*Extreme >pag 78*

*Devil >pag 79*

## HEADLIGHTS-MASCHERINE V-FACE

### INNOVATIVE DESIGN

Universal headlight, studied for the off-road use. It's composed of two elements whose colours can be changed, connected with four screws.

### DESIGN INNOVATIVO

Mascherina universale, studiata per abbinarsi alle più diffuse moto da fuoristrada. È realizzata in robusto e leggero polipropilene, con faro alogeno omologato da 12v/35w.

€ 84.95



V-Face headlight  
Neon Yellow-Black  
**R-MASKGFNR008**



RM Yellow-Black  
**R-MASKGINR008**



KX Green-Black  
**R-MASKVENR008**



CR Red-Black  
**R-MASKRSNR008**



K Orange-Black  
**R-MASKARNR008**



White-Black  
**R-MASKBNR008**



Black  
**R-MASKNR008**



YZ Blue-Black  
**R-MASKBLNR008**



TM Blue-Black  
**R-MASKBLTMNR8**



Supplied with four rubber bands to be fixed to the fork and with a large hole for the front brake tube. In the section "accessories and headlight's replacement parts" there is the availability of a big range of products which can make unique your V-Face headlight.

*Composta da due elementi, dal colore personalizzabile, uniti tramite 4 viti. Fornita con quattro elastici in gomma per permetterne il fissaggio ai foderi della forcella e di anello di passaggio per il tubo freno anteriore. Nella sezione "accessori e ricambi mascherine" è disponibile un'ampia scelta di componenti con cui rendere unica la tua mascherina V-Face.*





€ 114.95

V-Face Led headlight  
Red CRF-Black  
**R-MASKRSNR009**



**EVEN MORE BRIGHTNESS  
THANKS TO 2 ADDITIONAL SIDE LED LIGHTS**

For this type of headlight it's the same explained for the v-face, but it has two more ornamental DRL (Daytime Running Lights) led lights at both sides with ixed rubber gasket in order to be protected from mud and water.

**ANCORA PIÙ LUMINOSA GRAZIE AI 2 LED LATERALI**

Per questa mascherina vale quanto detto per la v-face ma possiede in piu' delle luci diurne a led protette da una guarnizione di tenuta che impedisce l'ingresso di fango ed acqua.



RM Yellow-Black  
**R-MASKGINR009**



KX Green-Black  
**R-MASKVENR009**



Yellow Neon-Black  
**R-MASKGFNR009**



K Orange-Black  
**R-MASKARNR009**



YZ Blue-Black  
**R-MASKBLNR009**



TM Blue-Black  
**R-MASKBLTMNR9**



White-Black  
**R-MASKBNNR009**



Black  
**R-MASKNR00009**

# HEADLIGHTS-MASCHERINE V-FACE FULL LED

## FULL LED HEADLIGHT

Universal headlight, suitable to the most common offroad bikes on the market. Made of strong technopolymer with homologated led light 12V / 14,5W. It provides a clearer and powerful light beam than the original.

## FARO FULL LED

Mascherina universale, studiata per abbinarsi alle più diffuse moto da fuoristrada.

È realizzata in robusto e leggero polipropilene, con faro a tecnologia LED omologato da 12v/14,5w.

Garantisce un fascio di luce più chiaro e potente rispetto alla classica lampada.



Black  
R-MASKNR00010



White-Black  
R-MASKBNNR010

€ 154.95



RM Yellow-Black  
R-MASKGINR010



KX Green-Black  
R-MASKVENR010



Yellow Neon-Black  
R-MASKGFNR010



K Orange-Black  
R-MASKARNR010



YZ Blue-Black  
R-MASKBLNR010



TM Blue-Black  
R-MASKBLTMNR010

**1000 LUMEN**

V-Face FullLed headlight  
Red CRF-Black  
R-MASKRSNR010

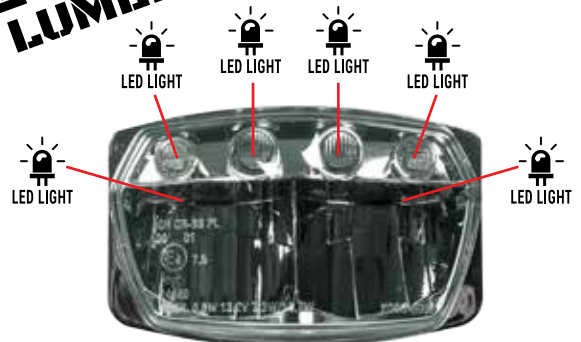

Before using check that the electric and electronic parts of the motorbike are in perfect state of use. It is not recommended for use on small displacement models without a charging system.

Prima dell'utilizzo verificare che le parti elettriche ed elettroniche della moto siano in perfetto stato d'uso.

Si sconsiglia il montaggio su modelli di piccola cilindrata privi di impianto di ricarica.

## LED HEADLIGHT



LED headlight  
R-FAR00000004

€ 114.95



# HEADLIGHTS—MASCHERINE GENESIS



€ 69.95



Genesis headlight  
R-MASKVE00006

## SLENDER AND COMPACT DESIGN

Headlight made of polypropylene with approved 12v/35w light.

It has four rubber bands to be fixed to the fork and a wide hole for the front brake tube.

In the section "accessories and headlight's replacement parts" there is the availability of specific fork's spacers sets.

## LINEE FILANTI E DESIGN COMPATTO

Mascherina universale realizzata in polipropilene con faretto omologato da 12v/35w.

Dispone di quattro elastici per il fissaggio alle forcelle e di un ampio passaggio per il tubo freno anteriore.

Nella sezione "accessori e ricambi mascherine" in opzione sono disponibili specifici distanziatori forcella.

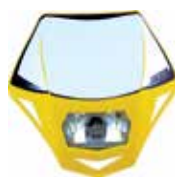

RM Yellow  
R-MASKGI00006



K Orange  
R-MASKAR00006



CR Red  
R-MASKRS00006



White  
R-MASKBN00006



Black  
R-MASKNR00006



YZ Blue  
R-MASKBL00006



€ 64.95

Matrix headlight  
R-MASKBN00007

## WITH ITS SHARP-CORNERED AND ESSENTIAL SHAPE

The universal matrix headlight is realized with shock resistant polypropylene and provided with an approved 12V/35w light. Supplied with four bands to be fixed to the fork and with a hole for the front brake tube. In the section "accessories and headlight's replacement parts" you can find all the available products for your Matrix headlight.

## FORME SPIGOLOSE ED ESSENZIALI

La mascherina universale Matrix è realizzata in polipropilene antiurto e dotata di faretto omologato da 12v/35w. È fornita con quattro elastici per il fissaggio ai foderi forcella ed un anello passatubo. Vai alla sezione "accessori e ricambi mascherine" per trovare tutti i prodotti disponibili per la tua mascherina Matrix.



White  
R-MASKBN00007



Black  
R-MASKNR00007



## HEADLIGHTS-MASCHERINE REPLACEMENT PARTS, ACCESSORIES / RICAMBI E ACCESSORI



V-Face light frame  
plastic replacement  
**R-BASEMASKVE8**

€ 18.95



Silver  
**R-BASEMASKSI8**



Black  
**R-BASEMASKNR8**



HSQ Red  
**R-BASEMASKRQ8**



RM Yellow  
**R-BASEMASKGI8**



K Orange  
**R-BASEMASKAR8**



CR Red  
**R-BASEMASKRS8**



YZ Blue  
**R-BASEMASKBL8**



White  
**R-BASEMASKBN8**



V-Face number plate  
plastic replacement  
**R-TABMASKBL08**

€ 18.95



RM Yellow  
**R-TABMASKGI08**



K Orange  
**R-TABMASKAR08**



CR Red  
**R-TABMASKRS08**



Neon Yellow  
**R-TABMASKGF08**



White  
**R-TABMASKBN08**



Silver  
**R-TABMASKSI08**



Black  
**R-TABMASKNR08**



KX Green  
**R-TABMASKVE08**



TM Blue  
**R-TABMASKBLTM8**

## HEADLIGHTS-MASCHERINE SPARE STICKERS TABLE GENESIS - MATRIX



GENESIS headlight replacement pvc decal  
**R-ADMASK6BN01**

€ 5.95



MATRIX headlight replacement pvc decal  
**R-ADMASK7BN01**

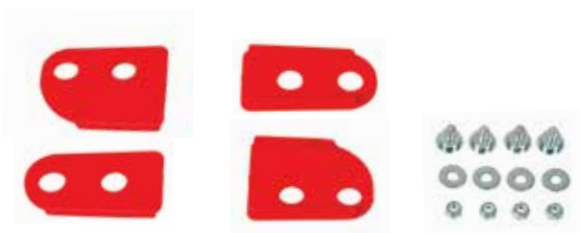

Set spacers for headlight  
**R-DSMASK6RS00**

| COLOR     | CODE                 | PRICE   |
|-----------|----------------------|---------|
| K Orange  | <b>R-DSMASK6AR00</b> | € 10,95 |
| YZ Blue   | <b>R-DSMASK6BL00</b> | € 10,95 |
| TM Blue   | <b>R-DSMASK6BLTM</b> | € 10,95 |
| White     | <b>R-DSMASK6BN00</b> | € 10,95 |
| RM Yellow | <b>R-DSMASK6GI00</b> | € 10,95 |
| Black     | <b>R-DSMASK6NR00</b> | € 10,95 |
| CR Red    | <b>R-DSMASK6RS00</b> | € 10,95 |
| Silver    | <b>R-DSMASK6SI00</b> | € 10,95 |
| KX Green  | <b>R-DSMASK6VE00</b> | € 10,95 |



**€ 59.95**

Halogen light replacing for V-face headlights  
**R-FAR00000002**



**€ 54.95**

Halogen light replacing for Matrix and Genesis headlights  
**R-FAR00000001**



**€ 42.95**

Led replacement kit for V-Face Led  
**R-REPLEDNT009**



**€ 114.95**

LED headlight replacing for V-Face Full Led headlights  
**R-FAR00000004**

**€ 5.95**



Universal fairlead ring - screws included black color  
**R-APC0000NR00**

4 X REPLACEMENT MOUNTING ELASTIC BANDS  
V-Face, Genesis, Matrix  
**R-ELASTNR0023**

**€ 20.95**



4 X REPLACEMENT MOUNTING ELASTIC BANDS  
V-Face, Genesis, Matrix  
**R-ELASTNR0006**

**€ 18.95**

# HEADLIGHTS-MASCHERINE LED R3000 CONVERSION KIT

ORIGINAL

BRIGHTNESS  
+ 300%

Approvals:  
CE - ROHS - DOT

Kit led Rtech R3000  
R-LEDRTECH016

€ 64.95



## KIT LED RTECH R3000

3000 lumens with R3000 32W you will get +300% of visibility!!

Thanks to powerful and silent integrated Turbo fan (12,000 rev / min) the heat generated

It is dissipated while maintaining a constant operating temperature and the performance of the LEDs.

Reliability (anti overheating included).

Suitable to most motorcycles in commerce.

The package includes adapters for mounting lights lamps designed for H1, H2, H3, H4, H7, KTM original and Sherco

## 3000 LUMEN, IL 300% DI VISIBILITÀ IN PIÙ!!

*Grazie al potente e silenzioso ventilatore Turbo integrato (12.000 Giri/Min) il calore generato viene dissipato mantenendo costante la temperatura di esercizio e le prestazioni dei led.*

*Massima affidabilità (protezione anti surriscaldamento inclusa).*

*Adatto alla maggior parte dei motocicli in commercio.*

*La confezione include il set mezzelune distanziali e gli adattatori per il montaggio su fanali predisposti per lampade H1, H2, H3, H4, H7, Ktm originale e Sherco, Husqvarna, Beta e TM.*

### PLUG AND PLAY – DO NOT REQUIRE ADDITIONAL UNIT

Replacing the original halogen bulb is quick and easy thanks to fitting adapters.



**1**  
Remove the halogen  
light bulb



**2**  
Place the Adapter and lock it  
with the special safety retainer



**3**  
INSERT the SPRING and the LED  
as indicated



**4**  
Turn gently the LED until it  
locks on bayonet connector

**CHARACTERISTICS**

Power: 32W  
 Brightness: 3000 lumen (high) - 2200 lumen (low beam)  
 Voltage: DC 9 Volt min. - 36 Volt max (12 Volt constant)  
 Frequency: 120 KHZ - 160 KHZ  
 Intensity: 3A  
 Beam angle: 360°  
 Approvals: CE - ROHS - DOT  
 Operating temperature: da -45°C a 105°C  
 Waterproof: IP68  
 Length: 50.000 hours  
 Light color: 6000K (clear light)

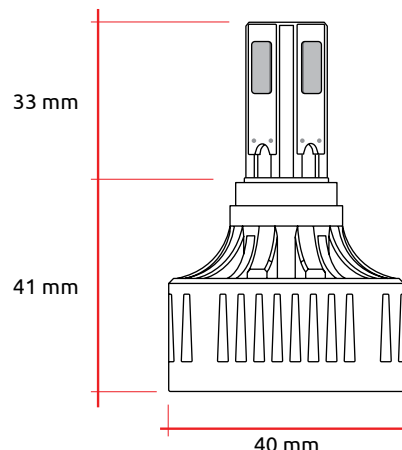

**CONVERSION KIT LED ADAPTORS AND SPACERS INCLUDED**

Adapters for mounting lights lamps designed for H1, H2, H3, H4, H7, KTM original, Sherco, Husqvarna, Beta, TM.

**ADATTATORI LAMPADA E DISTANZIALI INCLUSI**

Adattatori per il montaggio su fanali predisposti per lampade H1, H2, H3, H4, H7, Ktm originale, Sherco, Husqvarna, Beta e TM.

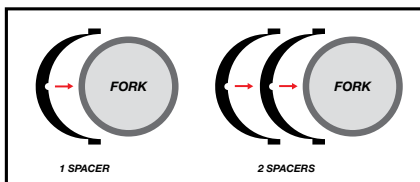

**CAUTION !!**

On KTM EXC/XC-W 250/300 carburetor models, Husqvarna TE/TX 250/300 and Beta RR 250/300, we recommend feeding directly from the positive battery, thus avoiding high engine peaks. The connection must be made from the positive of the battery to the common positive on the light switch. It is not recommended for use on small displacement models without a charging system. On the 4 stroke injection models the product is plug & play.

**ATTENZIONE !!**

Sui modelli a carburatore Ktm EXC 250/300, Husqvarna TE 250/300 e Beta RR 250/300 si consiglia l'alimentazione direttamente dal positivo della batteria, evitando così gli elevati sbalzi di tensione che questi modelli hanno soprattutto ad elevati regimi motore. Il collegamento andrà effettuato dal positivo della batteria al positivo comune sul devio luci. Si sconsiglia l'uso su motocicli privi di impianto di ricarica e/o di piccola cilindrata. Sui modelli 4T ad iniezione il prodotto è plug & play.

**HEADLIGHTS-MASCHERINE SPACERS SET HEADLIGHT KIT**



Spacers set headlight (half moon shape) suitable to V-Face, Matrix e Genesis  
 Set mezzelune distanziali per V-Face, Matrix e Genesis  
**R-DSMASK16NR**

€ 11.95



# TAIL-LIGHT / PORTATARGA INTEGRA EURO VERSION



**EURO**  
VERSION

Integra racing tail-light EU VERSION - Black  
Portatarga a led Integra racing VERSIONE EU - nero  
**R-PTLEDONR012**

## MADE IN TWO VERSIONS: RACING AND STREET APPROVED

The plate support can also fit on scooters/mopeds plates.  
Available in white and black.

## REALIZZATO IN DUE VERSIONI: RACING ED OMOLOGATO

Il supporto targa si può adattare anche alle targhe dei ciclomotori  
Eliminando tramite i pretagli la porzione in eccedenza.  
Disponibile in bianco ed in nero

**€ 54.95**



**Reinforced plate frame  
Cornice targa rinforzata**

Rear light 12 with led + 3 led lighting plate  
**100% Waterproof**

Fanale posteriore a 12 led + 3 led per luce targa  
**Impermeabile al 100%**

Housing and pre-holes for fixing **indicators**

Alloggiamento e pre-fori per il fissaggio **indicatori di direzione**

Pre-cut and fixing holes for **scooter/moped plates**

Alloggiamento e foratura per fissaggio **targhe ciclomotori**

Housing and fixing holes for **motorcycle plates**

Alloggiamento e forature di fissaggio per **targhe motocicli**

**Rear locking clips**  
Chiusure di bloccaggio rapido posteriori

Pre-cut for **eliminating stand reflector**  
**Supporto catadiottro rimovibile** tramite pre-taglio

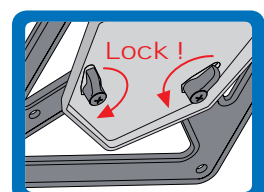

**30°**  
STREET APPROVED 30° - EU VERSIONS



**60°**  
RACING 60° - EU VERSION

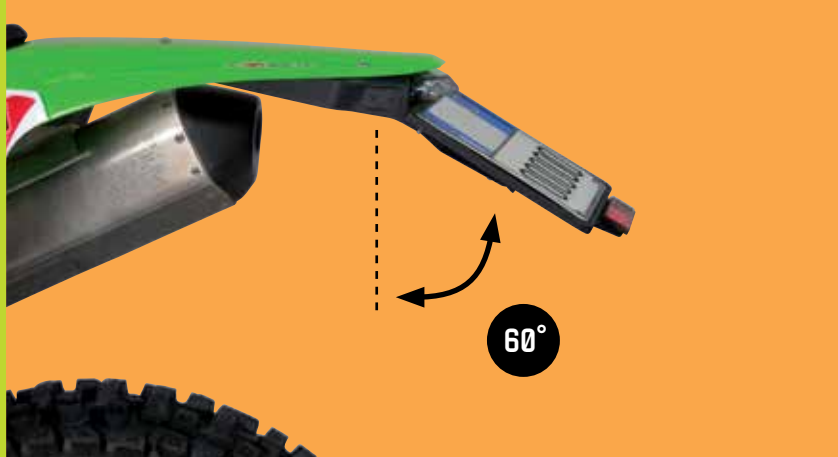

Available in two versions, street and racing approved and in two colour variations. The Integra plate is designed according to the new F.I.M. regulations with the obligation to use the original plate in of road races, allowing removal required in all cases such as cleaning the motorcycle or entry in a private circuit. The plate support can even its to the plates mopeds and scooters.

*Conforme alle nuove normative F.M.I. che fissano l'obbligo di utilizzo della targa originale nelle competizioni fuoristrada e ne permette la rimozione in tutti i casi necessari, ad esempio la pulizia della moto o l'ingresso in un circuito chiuso al traffico.*

**Reinforced plate frame  
Cornice targa rinforzata**

Integra Led tail-light street approved - EU VERSION - white  
Portatarga a led Integra street approved - VERSIONE EU - bianco  
**R-PTLED0BN312**

**€ 54.95**



| MODEL   | COLOR | CODE                 | PRICE   |
|---|-------|----------------------|---------|
| Integra Led tail-light racing - EU version          | White | <b>R-PTLED0BN012</b> | € 54,95 |
| Integra Led tail-light street approved - EU version | White | <b>R-PTLED0BN312</b> | € 54,95 |
| Integra Led tail-light racing - EU version          | Black | <b>R-PTLED0NR012</b> | € 54,95 |
| Integra Led tail-light street approved - EU version | Black | <b>R-PTLED0NR312</b> | € 54,95 |

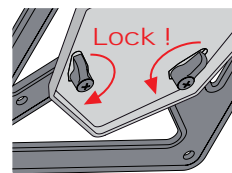

# TAIL-LIGHT / PORTATARGA INTEGRA USA VERSION



Integra racing tail-light - USA VERSION - black  
 Portatarga a led Integra racing - VERSIONE USA - nero  
**R-PTLED0NR015**

## MADE IN TWO VERSIONS: RACING AND STREET APPROVED

MADE FOR THE USA LICENSE PLATES.  
 Available in white and black.

## REALIZZATO IN DUE VERSIONI: RACING ED OMOLOGATO

La cornice targa e' studiata per alloggiare le targhe statunitensi.  
 Disponibile in colore bianco ed in nero

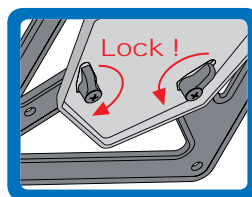

REAR LOCKING CLIPS  
 CHIUSURE DI BLOCCAGGIO RAPIDO

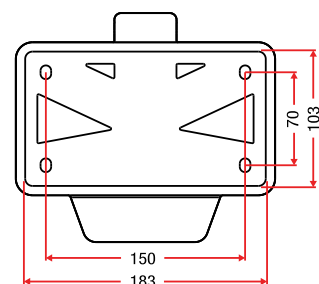

€ 54.95

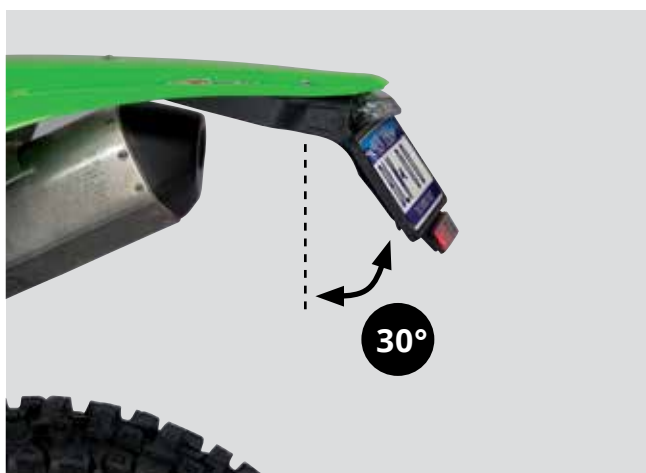

STREET APPROVED 30° - USA VERSION

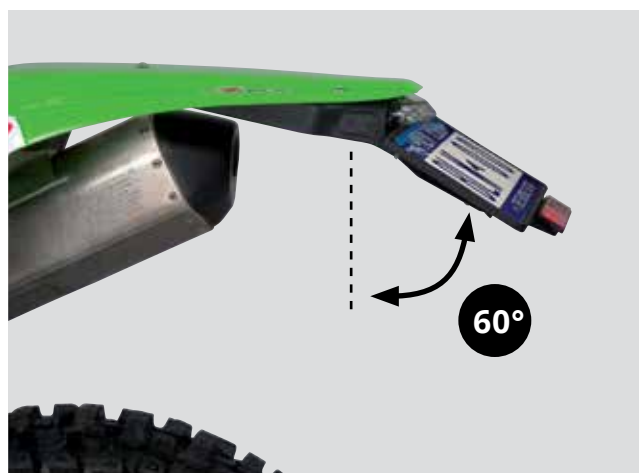

RACING 60° - USA VERSION

| MODEL  | COLOR | CODE          | PRICE   |
|--|-------|---------------|---------|
| Integra Led tail-light racing - USA version          | White | R-PTLED0BN015 | € 54,95 |
| Integra Led tail-light street approved - USA version | White | R-PTLED0BN315 | € 54,95 |
| Integra Led tail-light racing - USA version          | Black | R-PTLED0NR015 | € 54,95 |
| Integra Led tail-light street approved - USA version | Black | R-PTLED0NR315 | € 54,95 |

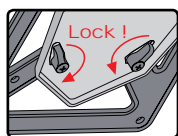

REAR LOCKING CLIPS



EU version  
R-PTLED0NR016

EU version  
R-PTLED0AR016

USA version  
R-PTLED0BN916

### INTEGRA TAIL-LIGHT DEVELOPED FOR KTM 2017-2023

Extremely rugged, uses the original points of fixation.  
Developed and designed for KTM 2017-2023 models enduro racing,  
allows you remove and replace quickly the plate thanks to the "Integra System" applied.  
**No more problems with the loss of license plate.**

### INTEGRA PER MODELLI KTM 2017-2023

*Estremamente robusto, sfrutta i punti d'appoggio dell'originale.  
Studiato appositamente per i modelli KTM 2017-2023 Enduro Racing,  
permette di rimuovere e rimontare rapidamente la targa grazie al "Sistema Integra" applicato.  
**Mai più problemi con la perdita della targa!***

### EU version

| MODELLO                       | DESCRIPTION                   | YEAR      | COLORE   | CODICE        | PRICE   |
|-------------------------------|-------------------------------|-----------|----------|---------------|---------|
| XC-W / EXC / EXCF - 125 > 500 | Integra racing KTM tail-light | 2017>2019 | Black    | R-PTLED0NR016 | € 59,95 |
|                               |                               |           | White    | R-PTLED0BN016 |         |
|                               |                               |           | K Orange | R-PTLED0AR016 |         |
| XC-W / EXC / EXCF - 125 > 500 | Integra racing KTM tail-light | 2020>2023 | Black    | R-PTLED0NR020 | € 59,95 |
|                               |                               |           | K Orange | R-PTLED0AR020 |         |

### USA version

| MODELLO                       | DESCRIPTION                   | YEAR      | COLORE   | CODICE        | PRICE   |
|-------------------------------|-------------------------------|-----------|----------|---------------|---------|
| XC-W / EXC / EXCF - 125 > 500 | Integra racing KTM tail-light | 2017>2019 | Black    | R-PTLED0NR916 | € 59,95 |
|                               |                               |           | White    | R-PTLED0BN916 |         |
|                               |                               |           | K Orange | R-PTLED0AR916 |         |
| XC-W / EXC / EXCF - 125 > 500 | Integra racing KTM tail-light | 2020>2023 | Black    | R-PTLED0NR920 | € 59,95 |
|                               |                               |           | K Orange | R-PTLED0AR920 |         |



## TAIL-LIGHT / PORTATARGA INTEGRA HUSQVARNA LED



Reinforced plate frame  
Cornice targa rinforzata



EU version  
R-PTLED0BN017

EU version  
R-PTLED0GQ017

EU version  
R-PTLED0NR017

€ 59.95

### INTEGRA TAIL-LIGHT DEVELOPED FOR HUSQVARNA 2017-2023

Extremely rugged, uses the original points of fixation. Developed and designed for Husqvarna 2017-2023 models enduro racing, allows you remove and replace quickly the plate thanks to the "Integra System" applied.

**No more problems with the loss of license plate.**

### INTEGRA PER MODELLI HUSQVARNA 2017-2023

*Estremamente robusto, sfrutta i punti d'appoggio dell'originale.*

*Studiato appositamente per i modelli HUSQVARNA 2017-2023 Enduro Racing, permette di rimuovere e rimontare rapidamente la targa grazie al "Sistema Integra" applicato.*

***Mai più problemi con la perdita della targa!***

### EU version

| MODELLO                  | DESCRIPTION                         | YEAR      | COLORE                       | CODICE  | PRICE   |
|--------------------------|-------------------------------------|-----------|------------------------------|---|---------|
| TE / FE / TX - 125 > 501 | Integra racing HUSQVARNA tail-light | 2017>2019 | Black<br>White<br>HSQ Yellow | R-PTLED0NR017<br>R-PTLED0BN017<br>R-PTLED0GQ017 | € 59,95 |
| TE / FE / TX - 125 > 501 | Integra racing HUSQVARNA tail-light | 2020>2023 | Black<br>HSQ Yellow          | R-PTLED0NR021<br>R-PTLED0GQ021                  | € 59,95 |

### USA version

| MODELLO                  | DESCRIPTION                         | YEAR      | COLORE                       | CODICE  | PRICE   |
|--------------------------|-------------------------------------|-----------|------------------------------|---|---------|
| TE / FE / TX - 125 > 501 | Integra racing HUSQVARNA tail-light | 2017>2019 | Black<br>White<br>HSQ Yellow | R-PTLED0NR917<br>R-PTLED0BN917<br>R-PTLED0GQ917 | € 59,95 |
| TE / FE / TX - 125 > 501 | Integra racing HUSQVARNA tail-light | 2020>2023 | Black<br>HSQ Yellow          | R-PTLED0NR921<br>R-PTLED0GQ921                  | € 59,95 |



USA version  
R-PTLED0GQ917





**INTEGRA TAIL-LIGHT DEVELOPED FOR BETA 2020-2023**

Extremely rugged, uses the original points of fixation.

**No more problems with the loss of license plate.**

**INTEGRA PER MODELLI BETA 2020-2023**

*Estremamente robusto, sfrutta i punti d'appoggio dell'originale.*

**Mai più problemi con la perdita della targa!**

**EU version**

| MODELLO      | DESCRIPTION                    | YEAR      | COLORE            | CODICE                                       | PRICE   |
|--------------|--------------------------------|-----------|-------------------|--|---------|
| RR 125 > 530 | Integra racing BETA tail-light | 2020>2023 | Black<br>Beta Red | <b>R-PTLED0NR022</b><br><b>R-PTLED0RB022</b> | € 59,95 |

**USA version**

| MODELLO      | DESCRIPTION                    | YEAR      | COLORE            | CODICE                                       | PRICE   |
|--------------|--------------------------------|-----------|-------------------|--|---------|
| RR 125 > 530 | Integra racing BETA tail-light | 2020>2023 | Black<br>Beta Red | <b>R-PTLED0NR922</b><br><b>R-PTLED0RB922</b> | € 59,95 |

**TAIL-LIGHT / PORTATARGA INTEGRA GAS GAS LED**

**INTEGRA TAIL-LIGHT DEVELOPED FOR GAS GAS 2021-2023**

Extremely rugged, uses the original points of fixation.

**No more problems with the loss of license plate.**

**INTEGRA PER MODELLI GAS GAS 2021-2023**

*Estremamente robusto, sfrutta i punti d'appoggio dell'originale.*

**Mai più problemi con la perdita della targa!**

**EU version**

| MODELLO               | DESCRIPTION                       | YEAR      | COLORE | CODICE               | PRICE   |
|-----------------------|-----------------------------------|-----------|--------|----------------------|---------|
| EC / EC-F 250-300-350 | Integra racing GAS GAS tail-light | 2021>2023 | Black  | <b>R-PTLED0NR019</b> | € 59,95 |

**USA version**

| MODELLO               | DESCRIPTION                       | YEAR      | COLORE | CODICE               | PRICE   |
|-----------------------|-----------------------------------|-----------|--------|----------------------|---------|
| EC / EC-F 250-300-350 | Integra racing GAS GAS tail-light | 2021>2023 | Black  | <b>R-PTLED0NR919</b> | € 59,95 |



Replacement Mount Only  
30 Degree Street - Black  
*Ricambio supporto targa  
Integra omologato - Nero*  
**R-REPPTNR9315**

**€ 24.95**



Replacement Mount Only  
60 Degree Race - Black  
**R-REPPTNR9015**

**€ 24.95**



Replacement Mount Only  
30 Degree Street - White  
*Ricambio supporto targa  
Integra omologato - Bianco*  
**R-REPPTBN9315**

**€ 24.95**



Replacement Mount Only  
60 Degree Race - White  
**R-REPPTBN9015**

**€ 24.95**



Replacement mount only  
Integra KTM racing 2017-2019  
*Ricambio supporto targa  
Integra KTM racing 2017-2019*  
**R-REPPTNR0016** - Black/Nero  
**R-REPPTBN0016** - White/Bianco  
**R-REPPTAR0016** - K Orange/Arancio K

**€ 24.95**



Replacement mount only  
Integra HUSQVARNA racing 2017-2019  
*Ricambio supporto targa  
Integra Husqvarna racing 2017-2019*  
**R-REPPTNR0017** - Black/Nero  
**R-REPPTBN0017** - White/Bianco  
**R-REPPTGQ0017** - HSQ Yellow/Giallo HSQ

**€ 24.95**

Replacement mount only  
Integra KTM racing 2020>2023  
*Ricambio supporto targa  
Integra KTM racing 2020>2023*  
**R-REPPTNR0020** - Black/Nero  
**R-REPPTAR0020** - K Orange/Arancio K

**€ 24.95**

Replacement mount only  
Integra HUSQVARNA racing 2020>2023  
*Ricambio supporto targa  
Integra Husqvarna racing 2020>2023*  
**R-REPPTNR0021** - Black/Nero  
**R-REPPTGQ0021** - HSQ Yellow/Giallo HSQ

**€ 24.95**

Replacement mount only  
Integra BETA racing 2020>2023  
*Ricambio supporto targa  
Integra BETA racing 2020>2023*  
**R-REPPTNR0022** - Black/Nero  
**R-REPPTRS0022** - Red/Rosso

**€ 24.95**

Replacement mount only  
Integra GAS GAS racing 2021-2023  
*Ricambio supporto targa  
Integra BETA racing 2021-2023*  
**R-REPPTNR0019** - Black/Nero

**€ 24.95**

## Reinforced plate frame - Cornice targa rinforzata



€ 11.95

Replacement license plate frame  
*Ricambio cornice targa Integra*  
EU version  
**R-REPTNR0012**



€ 11.95

Replacement license plate frame  
*Ricambio cornice targa Integra*  
USA version  
**R-REPTNR0015**



Replacement LED/Stop light Integra  
*Led di ricambio Integra con luce stop*  
**KTM/HUSQVARNA/GAS GAS**  
**R-LEDNT000016**

€ 35.95



Replacement LED Tail/Stop Light  
*Led di ricambio Integra con luce stop*  
**Integra EURO/USA**  
**R-LEDNT000012**

€ 35.95



Replacement LED Tail/Stop Light  
*Led di ricambio Integra con luce stop*  
**BETA**  
**R-LEDNT000022**

€ 35.95



## TAIL-LIGHT / PORTATARGA EXTREME

Extreme tail-light Universal Racing  
 Portatarga Extreme Racing Universale  
**R-PTLED3NR006**



### THE UNIQUE UNIVERSAL RACING TAIL-LIGHT

Compact dimensions for off-road use, characterized by high brightness not approved led light.



### PORTATARGA EXTREME RACING UNIVERSALE

Di dimensioni compatte per moto fuoristrada, caratterizzato dal fanalino a led ad alta luminosità.  
 Non omologato.

**TRANSPARENT LENS**  
**LENTE TRASPARENTE**

**€ 39.95**

**RED LENS**  
**LENTE ROSSA**



| MODEL                                     | COLOR | CODE                 | PRICE   |
|---|-------|----------------------|---------|
| Extreme LED-tail light - RED lens         | Black | <b>R-PTLED3NR006</b> | € 39,95 |
| Extreme LED-tail light - TRANSPARENT lens | Black | <b>R-PTLED4NR006</b> | € 39,95 |



Led replacement for Extreme tail-light  
 Ricambio led portatarga Extreme  
**R-LEDRS000006**

**€ 19.95**



Replacement lens transparent plate for Extreme tail-light  
 Lente ricambio neutra portatarga Extreme  
**R-LENTNT00006**

**€ 15.95**



Replacement lens red plate for extreme tail-light  
 Lente ricambio rossa portatarga Extreme  
**R-LENTRS00006**

**€ 15.95**

Devil racing tail-light, inclination 45°  
 Portatarga led Devil racing Inclinazione 45°  
**R-PTLEDONR007**



**EXCLUSIVE RUGGED COMPACT**

The unique resistant and compact universal taillight for of-road use, available in two inclinations: the racing one of 45° and the approved one of 30°, both provided with homologated led with taillight.

**PORTATARGA ROBUSTO E COMPATTO**

Portatarga universale per moto da fuoristrada.  
 Disponibile in due differenti inclinazioni, nella versione racing a 45° ed omologato a 30°.  
 Entrambe sono dotate di led omologato con luce targa.



Devil tail-light APPROVED FOR ROAD USE 30° angle  
 Portatarga led Devil omologato per uso stradale Inclinazione 30°  
**R-PTLEDONR008**

**€ 54.95**



Devil tail-light 45° angle  
 Portatarga led Devil racing Inclinazione 45°  
**R-PTLEDONR007**

**€ 54.95**



Replacement devil led tail-light approved for road use - red  
 Ricambio led portatarga Devil omologato - rosso  
**R-LEDRS000007**

**€ 35.95**





## **HONDA**

**Front fender** / Parafango anteriore >**pag 82**

**Vented front fender** / Parafango anteriore ventilato >**pag 83**

**Rear fender** / Parafango posteriore >**pag 84**

**Gas tank cover** / Copriserbatoio >**pag 85**

**Radiator shrouds** / Convogliatori aria radiatore >**pag 86**

**Side panels** / Tabbelle laterali portanumero >**pag 88**

**Air box covers** / Coperchi laterali cassa filtro >**pag 90**

**Oversize radiator louvers** / Griglie radiatore maggiorate >**pag 91**

**Front number plate** / Tabella portanumero anteriore >**pag 92**

**Fork protectors** / Parasteli forcella >**pag 94**

**Rear shock mud flap** / Paraspruzzi monoammortizzatore >**pag 95**

**Chain guide** / Cruna guida catena >**pag 96**

**Chain slider** / Slitta scorricatena forcellone >**pag 96**

**Replica plastics kit** / Kit plastiche replica >**pag 97**

# HONDA FRONT FENDER / PARAFANGO ANTERIORE



R-PACRFGR0021



R-PACFRFS0021

## AVAILABLE COLORS

CR Red Black White

**OEM** original color

| MOD         | CC          | YEAR        | NOTES | COLOR  | CODE          | PRICE   |
|-------------|-------------|-------------|-------|--------|---------------|---------|
| CR          | 80          | 1996 > 2002 | OEM   | CR Red | R-PACRORS0085 | € 25,95 |
| CR          | 85          | 2003 > 2007 | OEM   | CR Red | R-PACRORS0085 | € 25,95 |
| CRF         | 150         | 2007 > 2023 | OEM   | CR Red | R-PACFRFS0150 | € 25,95 |
|             |             |             |       | Black  | R-PACRFNR0150 |         |
|             |             |             |       | White  | R-PACRFBN0150 |         |
| CR          | 125-250     | 2004 > 2007 | OEM   | CR Red | R-PACRORS0004 | € 29,95 |
|             |             |             |       | Black  | R-PACRONR0004 |         |
|             |             |             |       | White  | R-PACROBN0004 |         |
| CR          | 125-250-500 | 2000 > 2003 | OEM   | CR Red | R-PACRORS0003 | € 29,95 |
|             |             |             |       | White  | R-PACROBN0003 |         |
| CRF         | 250         | 2004 > 2009 | OEM   | CR Red | R-PACRORS0004 | € 29,95 |
|             |             |             |       | Black  | R-PACRONR0004 |         |
|             |             |             |       | White  | R-PACROBN0004 |         |
| CRF         | 250         | 2010 > 2013 | OEM   | CR Red | R-PACFRFS0009 | € 29,95 |
|             |             |             |       | Black  | R-PACRFNR0009 |         |
|             |             |             |       | White  | R-PACRFBN0009 |         |
| CRF         | 250         | 2014 > 2017 | OEM   | CR Red | R-PACFRFS0013 | € 29,95 |
|             |             |             |       | Black  | R-PACRFNR0013 |         |
|             |             |             |       | White  | R-PACRFBN0013 |         |
| CRF         | 250         | 2018 > 2021 | OEM   | CR Red | R-PACFRFS0017 | € 29,95 |
|             |             |             |       | Black  | R-PACRFNR0017 |         |
|             |             |             |       | White  | R-PACRFBN0017 |         |
| CRF/CRF-RX  | 250         | 2022 > 2023 | OEM   | CR Red | R-PACFRFS0021 | € 29,95 |
|             |             |             |       | Black  | R-PACRFNR0021 |         |
|             |             |             |       | White  | R-PACRFBN0021 |         |
| CRF         | 450         | 2002-2003   | OEM   | CR Red | R-PACRORS0003 | € 29,95 |
|             |             |             |       | White  | R-PACROBN0003 |         |
| CRF         | 450         | 2004 > 2008 | OEM   | CR Red | R-PACRORS0004 | € 29,95 |
|             |             |             |       | Black  | R-PACRONR0004 |         |
|             |             |             |       | White  | R-PACROBN0004 |         |
| CRF         | 450         | 2009 > 2012 | OEM   | CR Red | R-PACFRFS0009 | € 29,95 |
|             |             |             |       | Black  | R-PACRFNR0009 |         |
|             |             |             |       | White  | R-PACRFBN0009 |         |
| CRF         | 450         | 2013 > 2016 | OEM   | CR Red | R-PACFRFS0013 | € 29,95 |
|             |             |             |       | Black  | R-PACRFNR0013 |         |
|             |             |             |       | White  | R-PACRFBN0013 |         |
| CRF         | 450         | 2017 > 2020 | OEM   | CR Red | R-PACFRFS0017 | € 29,95 |
|             |             |             |       | Black  | R-PACRFNR0017 |         |
|             |             |             |       | White  | R-PACRFBN0017 |         |
| CRF/CRF-RWE | 450         | 2021 > 2023 | OEM   | CR Red | R-PACFRFS0021 | € 29,95 |
|             |             |             |       | Black  | R-PACRFNR0021 |         |
|             |             |             |       | White  | R-PACRFBN0021 |         |
| CRF-RX      | 250         | 2019 > 2021 | OEM   | CR Red | R-PACFRFS0017 | € 29,95 |
|             |             |             |       | Black  | R-PACRFNR0017 |         |
|             |             |             |       | White  | R-PACRFBN0017 |         |
| CRF-RX      | 450         | 2017 > 2020 | OEM   | CR Red | R-PACFRFS0017 | € 29,95 |
|             |             |             |       | Black  | R-PACRFNR0017 |         |
|             |             |             |       | White  | R-PACRFBN0017 |         |
| CRF-RX      | 450         | 2021 > 2023 | OEM   | CR Red | R-PACFRFS0021 | € 29,95 |
|             |             |             |       | Black  | R-PACRFNR0021 |         |
|             |             |             |       | White  | R-PACRFBN0021 |         |
| CRFX        | 250         | 2004 > 2019 | OEM   | CR Red | R-PACRORS0004 | € 29,95 |
|             |             |             |       | Black  | R-PACRONR0004 |         |
|             |             |             |       | White  | R-PACROBN0004 |         |
| CRFX        | 450         | 2004 > 2017 | OEM   | CR Red | R-PACRORS0004 | € 29,95 |
|             |             |             |       | Black  | R-PACRONR0004 |         |
|             |             |             |       | White  | R-PACROBN0004 |         |
| CRFX        | 450         | 2019 > 2023 | OEM   | CR Red | R-PACFRFS0017 | € 29,95 |
|             |             |             |       | Black  | R-PACRFNR0017 |         |
|             |             |             |       | White  | R-PACRFBN0017 |         |
| CRF-L       | 450         | 2019 > 2021 | OEM   | CR Red | R-PACFRFS0017 | € 29,95 |
|             |             |             |       | Black  | R-PACRFNR0017 |         |
|             |             |             |       | White  | R-PACRFBN0017 |         |
| CRF-RWE     | 450         | 2019-2020   | OEM   | CR Red | R-PACFRFS0017 | € 29,95 |
|             |             |             |       | Black  | R-PACRFNR0017 |         |
|             |             |             |       | White  | R-PACRFBN0017 |         |
| XR          | 650         | 2000 > 2008 | OEM   | White  | R-PACROBN0003 | € 29,95 |

# HONDA VENTED FRONT FENDER / PARAFANGO ANTERIORE VENTILATO

ALL FENDERS ON THIS PAGE ARE VENTED AIRFLOW MODELS / PARAFANGO CON PRE-TAGLIO PER LA VENTILAZIONE



**NEON**



R-PACRFGF9913



R-PACRFRS9921

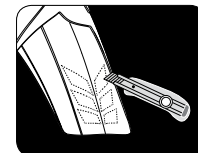

## AVAILABLE COLORS

- CR Red
- Black
- White
- Neon Yellow
- Neon Pink
- Quantum Grey

**OEM** original color - fluorescent color

| MOD         | CC  | YEAR        | NOTES                     | COLOR                                 |              | CODE          | PRICE   |               |
|-------------|-----|-------------|---------------------------|---------------------------------------|--------------|---------------|---------|---------------|
| CRF         | 250 | 2010 > 2013 | OEM - vented front fender | CR Red                                |              | R-PACRFRS0999 | € 29,95 |               |
|             |     |             |                           | vented front fender                   | White        |               |         | R-PACRFBN0999 |
|             |     |             |                           | vented front fender                   | Black        |               |         | R-PACRFNR0999 |
| CRF         | 250 | 2014 > 2017 | OEM - vented front fender | CR Red                                |              | R-PACRFRS9913 | € 29,95 |               |
|             |     |             |                           | vented front fender                   | White        |               |         | R-PACRFBN9913 |
|             |     |             |                           | vented front fender                   | Black        |               |         | R-PACRFNR9913 |
|             |     |             |                           | vented front fender                   | Neon Yellow  |               |         | R-PACRFGF9913 |
|             |     |             |                           | vented front fender                   | Neon Pink    |               |         | R-PACRFFU9913 |
| CRF         | 250 | 2018 > 2021 | OEM - vented front fender | CR Red                                |              | R-PACRFRS9917 | € 29,95 |               |
|             |     |             |                           | vented front fender                   | White        |               |         | R-PACRFBN9917 |
|             |     |             |                           | vented front fender                   | Black        |               |         | R-PACRFNR9917 |
|             |     |             |                           | vented front fender                   | Neon Yellow  |               |         | R-PACRFGF9917 |
|             |     |             |                           | vented front fender - Limited edition | Quantum Grey |               |         | R-PACRFRG9917 |
| CRF/CRF-RX  | 250 | 2022 > 2023 | OEM - vented front fender | CR Red                                |              | R-PACRFRS9921 | € 29,95 |               |
|             |     |             |                           | vented front fender                   | White        |               |         | R-PACRFBN9921 |
|             |     |             |                           | vented front fender                   | Black        |               |         | R-PACRFNR9921 |
|             |     |             |                           | vented front fender                   | Quantum Grey |               |         | R-PACRFRG9921 |
| CRF         | 450 | 2009 > 2012 | OEM - vented front fender | CR Red                                |              | R-PACRFRS0999 | € 29,95 |               |
|             |     |             |                           | vented front fender                   | White        |               |         | R-PACRFBN0999 |
|             |     |             |                           | vented front fender                   | Black        |               |         | R-PACRFNR0999 |
| CRF         | 450 | 2013 > 2016 | OEM - vented front fender | CR Red                                |              | R-PACRFRS9913 | € 29,95 |               |
|             |     |             |                           | vented front fender                   | White        |               |         | R-PACRFBN9913 |
|             |     |             |                           | vented front fender                   | Black        |               |         | R-PACRFNR9913 |
|             |     |             |                           | vented front fender                   | Neon Yellow  |               |         | R-PACRFGF9913 |
|             |     |             |                           | vented front fender                   | Neon Pink    |               |         | R-PACRFFU9913 |
| CRF         | 450 | 2017 > 2020 | OEM - vented front fender | CR Red                                |              | R-PACRFRS9917 | € 29,95 |               |
|             |     |             |                           | vented front fender                   | White        |               |         | R-PACRFBN9917 |
|             |     |             |                           | vented front fender                   | Black        |               |         | R-PACRFNR9917 |
|             |     |             |                           | vented front fender                   | Neon Yellow  |               |         | R-PACRFGF9917 |
|             |     |             |                           | vented front fender - Limited edition | Quantum Grey |               |         | R-PACRFRG9917 |
| CRF/CRF-RWE | 450 | 2021 > 2023 | OEM - vented front fender | CR Red                                |              | R-PACRFRS9921 | € 29,95 |               |
|             |     |             |                           | vented front fender                   | White        |               |         | R-PACRFBN9921 |
|             |     |             |                           | vented front fender                   | Black        |               |         | R-PACRFNR9921 |
|             |     |             |                           | vented front fender                   | Quantum Grey |               |         | R-PACRFRG9921 |
| CRF-RX      | 250 | 2019 > 2021 | OEM - vented front fender | CR Red                                |              | R-PACRFRS9917 | € 29,95 |               |
|             |     |             |                           | vented front fender                   | White        |               |         | R-PACRFBN9917 |
|             |     |             |                           | vented front fender                   | Black        |               |         | R-PACRFNR9917 |
|             |     |             |                           | vented front fender                   | Neon Yellow  |               |         | R-PACRFGF9917 |
|             |     |             |                           | vented front fender - Limited edition | Quantum Grey |               |         | R-PACRFRG9917 |
| CRF-RX      | 450 | 2017 > 2020 | OEM - vented front fender | CR Red                                |              | R-PACRFRS9917 | € 29,95 |               |
|             |     |             |                           | vented front fender                   | White        |               |         | R-PACRFBN9917 |
|             |     |             |                           | vented front fender                   | Black        |               |         | R-PACRFNR9917 |
|             |     |             |                           | vented front fender                   | Neon Yellow  |               |         | R-PACRFGF9917 |
|             |     |             |                           | vented front fender - Limited edition | Quantum Grey |               |         | R-PACRFRG9917 |
| CRF-RX      | 450 | 2021 > 2023 | OEM - vented front fender | CR Red                                |              | R-PACRFRS9921 | € 29,95 |               |
|             |     |             |                           | vented front fender                   | White        |               |         | R-PACRFBN9921 |
|             |     |             |                           | vented front fender                   | Black        |               |         | R-PACRFNR9921 |
|             |     |             |                           | vented front fender                   | Quantum Grey |               |         | R-PACRFRG9921 |
| CRFX        | 450 | 2019 > 2023 | OEM - vented front fender | CR Red                                |              | R-PACRFRS9917 | € 29,95 |               |
|             |     |             |                           | vented front fender                   | White        |               |         | R-PACRFBN9917 |
|             |     |             |                           | vented front fender                   | Black        |               |         | R-PACRFNR9917 |
|             |     |             |                           | vented front fender                   | Neon Yellow  |               |         | R-PACRFGF9917 |
|             |     |             |                           | vented front fender - Limited edition | Quantum Grey |               |         | R-PACRFRG9917 |
| CRF-L       | 450 | 2019 > 2021 | OEM - vented front fender | CR Red                                |              | R-PACRFRS9917 | € 29,95 |               |
|             |     |             |                           | vented front fender                   | White        |               |         | R-PACRFBN9917 |
|             |     |             |                           | vented front fender                   | Black        |               |         | R-PACRFNR9917 |
|             |     |             |                           | vented front fender                   | Neon Yellow  |               |         | R-PACRFGF9917 |
|             |     |             |                           | vented front fender - Limited edition | Quantum Grey |               |         | R-PACRFRG9917 |
| CRF-RWE     | 450 | 2019-2020   | OEM - vented front fender | CR Red                                |              | R-PACRFRS9917 | € 29,95 |               |
|             |     |             |                           | vented front fender                   | White        |               |         | R-PACRFBN9917 |
|             |     |             |                           | vented front fender                   | Black        |               |         | R-PACRFNR9917 |
|             |     |             |                           | vented front fender                   | Neon Yellow  |               |         | R-PACRFGF9917 |
|             |     |             |                           | vented front fender - Limited edition | Quantum Grey |               |         | R-PACRFRG9917 |

# HONDA REAR FENDER / PARAFANGO POSTERIORE



R-PPCRFGR0021



R-PPCRFNR0021



R-PPCRFRS0021



R-PPCRFBN0021

## AVAILABLE COLORS





**OEM** original color - fluorescent color

| MOD         | CC      | YEAR        | NOTES  | COLOR        |  | CODE          | PRICE   |
|-------------|---------|-------------|--|--------------|--|---------------|---------|
| CR          | 80      | 1996 > 2002 | OEM  | CR Red       |  | R-PPCR0RS0085 | € 27,95 |
| CR          | 85      | 2003 > 2007 | OEM  | CR Red       |  | R-PPCR0RS0085 | € 27,95 |
| CRF         | 150     | 2007 > 2023 | OEM  | CR Red       |  | R-PPCRFBN0150 | € 27,95 |
|             |         |             |  | White        |  | R-PPCRFBN0150 |         |
|             |         |             |  | Black        |  | R-PPCRFNR0150 |         |
| CR          | 125-250 | 2000-2001   | OEM  | CR Red       |  | R-PPCR0RS0001 | € 31,95 |
| CR          | 125-250 | 2002 > 2007 | OEM  | CR Red       |  | R-PPCR0RS0203 | € 31,95 |
| CRF         | 250     | 2004-2005   | OEM  | White        |  | R-PPCR0BN0203 |         |
|             |         |             |  | Black        |  | R-PPCR0NR0203 |         |
|             |         |             |  | CR Red       |  | R-PPCRFRS0004 | € 31,95 |
| CRF         | 250     | 2006 > 2009 | OEM 2009<br>OEM 2006 > 2008  | White        |  | R-PPCRFBN0004 |         |
|             |         |             |  | Black        |  | R-PPCRFNR0004 |         |
|             |         |             |  | CR Red       |  | R-PPCRFRS0006 | € 31,95 |
| CRF         | 250     | 2010 > 2013 | OEM  | White        |  | R-PPCRFBN0006 | € 31,95 |
|             |         |             |  | Black        |  | R-PPCRFNR0006 |         |
|             |         |             |  | CR Red       |  | R-PPCRFRS0006 |         |
| CRF         | 250     | 2014 > 2017 | OEM  | White        |  | R-PPCRFBN0009 | € 31,95 |
|             |         |             |  | Black        |  | R-PPCRFNR0009 |         |
|             |         |             |  | CR Red       |  | R-PPCRFRS0009 |         |
| CRF         | 250     | 2018 > 2021 | OEM  | White        |  | R-PPCRFBN0013 | € 31,95 |
|             |         |             |  | Black        |  | R-PPCRFNR0013 |         |
|             |         |             |  | CR Red       |  | R-PPCRFRS0013 |         |
|             |         |             |  | Neon Yellow  |  | R-PPCRFGF0013 |         |
|             |         |             |  | Neon Pink    |  | R-PPCRFFU0013 |         |
| CRF         | 250     | 2018 > 2021 | OEM  | White        |  | R-PPCRFBN0017 | € 31,95 |
|             |         |             |  | Black        |  | R-PPCRFNR0017 |         |
|             |         |             |  | CR Red       |  | R-PPCRFRS0017 |         |
|             |         |             |  | Neon Yellow  |  | R-PPCRFGF0017 |         |
|             |         |             |  | Quantum Grey |  | R-PPCRFGR0017 |         |
| CRF/CRF-RX  | 250     | 2022 > 2023 | Limited Edition<br>OEM   | CR Red       |  | R-PPCRFRS0021 | € 32,95 |
| CRF         | 450     | 2002 > 2004 | OEM  | White        |  | R-PPCRFBN0021 |         |
|             |         |             |  | Black        |  | R-PPCRFNR0021 |         |
|             |         |             |  | Quantum Grey |  | R-PPCRFGR0021 |         |
|             |         |             |  | CR Red       |  | R-PPCRFRS0203 | € 31,95 |
| CRF         | 450     | 2005 > 2008 | OEM  | Black        |  | R-PPCRFNR0203 |         |
|             |         |             |  | CR Red       |  | R-PPCRFRS0005 | € 31,95 |
| CRF         | 450     | 2009 > 2012 | OEM  | White        |  | R-PPCRFBN0005 |         |
|             |         |             |  | Black        |  | R-PPCRFNR0005 |         |
|             |         |             |  | CR Red       |  | R-PPCRFRS0005 |         |
| CRF         | 450     | 2009 > 2012 | OEM  | White        |  | R-PPCRFBN0009 | € 31,95 |
|             |         |             |  | Black        |  | R-PPCRFNR0009 |         |
|             |         |             |  | CR Red       |  | R-PPCRFRS0009 |         |
| CRF         | 450     | 2013 > 2016 | OEM  | White        |  | R-PPCRFBN0013 | € 31,95 |
|             |         |             |  | Black        |  | R-PPCRFNR0013 |         |
|             |         |             |  | CR Red       |  | R-PPCRFRS0013 |         |
| CRF         | 450     | 2017 > 2020 | OEM  | Neon Yellow  |  | R-PPCRFGF0013 |         |
|             |         |             |  | Neon Pink    |  | R-PPCRFFU0013 |         |
|             |         |             |  | CR Red       |  | R-PPCRFRS0017 | € 31,95 |
|             |         |             |  | White        |  | R-PPCRFBN0017 |         |
|             |         |             |  | Black        |  | R-PPCRFNR0017 |         |
| CRF/CRF-RWE | 450     | 2021 > 2023 | OEM  | Neon Yellow  |  | R-PPCRFGF0017 |         |
|             |         |             |  | Quantum Grey |  | R-PPCRFGR0017 |         |
|             |         |             |  | CR Red       |  | R-PPCRFRS0021 | € 32,95 |
|             |         |             |  | White        |  | R-PPCRFBN0021 |         |
|             |         |             |  | Black        |  | R-PPCRFNR0021 |         |
| CRFX        | 250     | 2004 > 2019 | OEM 2009 > 2019 - LED not included<br>OEM 2004 > 2008 - LED not included<br>LED not included | Quantum Grey |  | R-PPCRFGR0021 |         |
|             |         |             |  | White        |  | R-PPCRFXBN004 | € 36,95 |
|             |         |             |  | CR Red       |  | R-PPCRFXRS004 |         |
|             |         |             |  | Black        |  | R-PPCRFXNR004 |         |
| CRFX        | 450     | 2005 > 2017 | OEM 2009 > 2017 - LED not included<br>OEM 2005 > 2008 - LED not included<br>LED not included | White        |  | R-PPCRFXBN005 | € 36,95 |
|             |         |             |  | CR Red       |  | R-PPCRFXRS005 |         |
|             |         |             |  | Black        |  | R-PPCRFXNR005 |         |

## HONDA REAR FENDER / PARAFANGO POSTERIORE

**OEM** original color -  fluorescent color

| MOD   | CC            | YEAR        | NOTES           | COLOR   | CODE          | PRICE       |
|---|---------------|-------------|-----------------|---|---------------|-------------|
| CRF-RX  | 450           | 2017 > 2020 | OEM             | CR Red  | R-PPCRFRS0017 | € 31,95     |
|   |               |             |                 | White   | R-PPCRFBN0017 |             |
|   |               |             |                 | Black   | R-PPCRFNR0017 |             |
|   |               |             |                 | Neon Yellow  | R-PPCRFGF0017 |             |
|   |               |             |                 | Quantum Grey  | R-PPCRFGR0017 |             |
| CRF-RX  | 450           | 2021 > 2023 | OEM             | CR Red  | R-PPCRFRS0021 | € 32,95     |
|   |               |             |                 | White   | R-PPCRFBN0021 |             |
|   |               |             |                 | Black   | R-PPCRFNR0021 |             |
|   |               |             |                 | Quantum Grey  | R-PPCRFGR0021 |             |
|   |               |             |                 | CR Red  | R-PPCRFRS0017 |             |
| White   | R-PPCRFBN0017 |             |                 |   |               |             |
| Black   | R-PPCRFNR0017 |             |                 |   |               |             |
| Neon Yellow  | R-PPCRFGF0017 |             |                 |   |               |             |
| Quantum Grey  | R-PPCRFGR0017 |             |                 |   |               |             |
| CRF-RWE   | 450           | 2019-2020   | OEM             | CR Red  | R-PPCRFRS0017 | € 31,95     |
|   |               |             |                 | White   | R-PPCRFBN0017 |             |
|   |               |             |                 | Black   | R-PPCRFNR0017 |             |
|   |               |             |                 | Neon Yellow  | R-PPCRFGF0017 |             |
|   |               |             |                 | Quantum Grey  | R-PPCRFGR0017 |             |
| CRFX  | 250-450       | 2004 > 2023 | Limited Edition | CRFX LED light  | R-FNCRFX00004 | € 20,95     |
|   |               |             |                 | XR  | 250-400       | 1996 > 2008 |

## HONDA GAS TANK COVER / COPRISERBATOIO



R-COVSRCFNR1



R-COVSRCFRS1



R-COVSRCFBL1



R-COVSRCFBN1







R-COVSRCFGF1

 **NEON**

### AVAILABLE COLORS

-  CR Red
-  Black
-  White
-  YZ Blue
-  Neon Yellow

**OEM** original color -  fluorescent color

| MOD     | CC  | YEAR        | NOTES | COLOR   | CODE         | PRICE   |
|---------|-----|-------------|-------|---|--------------|---------|
| CRF     | 250 | 2018 > 2021 | OEM   | Black   | R-COVSRCFNR1 | € 29,95 |
|         |     |             |       | CR Red  | R-COVSRCFRS1 |         |
|         |     |             |       | Neon Yellow  | R-COVSRCFGF1 |         |
|         |     |             |       | YZ Blue   | R-COVSRCFBL1 |         |
|         |     |             |       | White   | R-COVSRCFBN1 |         |
| CRF     | 450 | 2017 > 2020 | OEM   | Black   | R-COVSRCFNR1 | € 29,95 |
|         |     |             |       | CR Red  | R-COVSRCFRS1 |         |
|         |     |             |       | Neon Yellow  | R-COVSRCFGF1 |         |
|         |     |             |       | YZ Blue   | R-COVSRCFBL1 |         |
|         |     |             |       | White   | R-COVSRCFBN1 |         |
| CRF-RWE | 450 | 2019-2020   | OEM   | Black   | R-COVSRCFNR1 | € 29,95 |
|         |     |             |       | CR Red  | R-COVSRCFRS1 |         |
|         |     |             |       | Neon Yellow  | R-COVSRCFGF1 |         |
|         |     |             |       | YZ Blue   | R-COVSRCFBL1 |         |
|         |     |             |       | White   | R-COVSRCFBN1 |         |



R-CVCRFRS0021

## AVAILABLE COLORS



**OEM** original color - fluorescent color

| MOD | CC      | YEAR        | NOTES                                     | COLOR           | CODE          | PRICE   |
|-----|---------|-------------|---|-----------------|---------------|---------|
| CR  | 85      | 2003 > 2007 | OEM                                       | CR Red          | R-CVCRORS0085 | € 49,95 |
| CRF | 150     | 2007 > 2023 | OEM                                       | CR Red          | R-CVCRFRS0150 | € 49,95 |
|     |         |             |   | White           | R-CVCRFBN0150 |         |
|     |         |             |   | Black           | R-CVCRFNR0150 |         |
| CR  | 125-250 | 2000-2001   | OEM                                       | CR Red          | R-CVCRORS0001 | € 57,95 |
| CR  | 125-250 | 2002 > 2007 | OEM                                       | CR Red          | R-CVCRORS0203 | € 57,95 |
|     |         |             |   | White           | R-CVCR0BN0203 |         |
|     |         |             |   | Black           | R-CVCR0NR0203 |         |
| CRF | 250     | 2004 > 2009 | OEM                                       | CR Red          | R-CVCRFRS0004 | € 57,95 |
|     |         |             |   | White           | R-CVCRFBN0004 |         |
|     |         |             |   | Black           | R-CVCRFNR0004 |         |
| CRF | 250     | 2010 > 2013 | OEM                                       | CR Red          | R-CVCRFRS0009 | € 57,95 |
|     |         |             |   | White           | R-CVCRFBN0009 |         |
|     |         |             |   | Black           | R-CVCRFNR0009 |         |
| CRF | 250     | 2014 > 2017 | OEM                                       | CR Red /White   | R-CVCRFRSBN13 | € 59,95 |
|     |         |             |   | CR Red          | R-CVCRFRS0013 |         |
|     |         |             |   | White           | R-CVCRFBN0013 |         |
|     |         |             |   | Black           | R-CVCRFNR0013 |         |
|     |         |             |   | Neon Yellow     | R-CVCRFGF0013 |         |
|     |         |             |   | Neon Pink       | R-CVCRFFU0013 |         |
| CRF | 250     | 2018 > 2021 | Limited Edition<br>OEM<br>Limited Edition | CR Red /Black   | R-CVCRFRSNR17 | € 59,95 |
|     |         |             |   | CR Red /YZ Blue | R-CVCRFRSBL17 |         |
|     |         |             |   | CR Red          | R-CVCRFRS0017 |         |
|     |         |             |   | White           | R-CVCRFBN0017 |         |
|     |         |             |   | Black           | R-CVCRFNR0017 |         |
|     |         |             |   | Neon Yellow     | R-CVCRFGF0017 |         |
|     |         |             |   | Quantum Grey    | R-CVCRFGR0017 |         |
| CRF | 250     | 2022 > 2023 | Limited Edition<br>OEM                    | CR Red          | R-CVCRFRS0021 | € 59,95 |
|     |         |             |   | White           | R-CVCRFBN0021 |         |
|     |         |             |   | Black           | R-CVCRFNR0021 |         |
|     |         |             |   | Quantum Grey    | R-CVCRFGR0021 |         |
| CRF | 450     | 2002 > 2004 | OEM                                       | CR Red          | R-CVCRFRS0203 | € 57,95 |
|     |         |             |   | Black           | R-CVCRFNR0203 |         |
| CRF | 450     | 2005 > 2008 | OEM                                       | CR Red          | R-CVCRFRS0005 | € 57,95 |
|     |         |             |   | White           | R-CVCRFBN0005 |         |
|     |         |             |   | Black           | R-CVCRFNR0005 |         |
| CRF | 450     | 2009 > 2012 | OEM                                       | CR Red          | R-CVCRFRS0009 | € 57,95 |
|     |         |             |   | White           | R-CVCRFBN0009 |         |
|     |         |             |   | Black           | R-CVCRFNR0009 |         |
| CRF | 450     | 2013 > 2016 | OEM                                       | CR Red /White   | R-CVCRFRSBN13 | € 59,95 |
|     |         |             |   | CR Red          | R-CVCRFRS0013 |         |
|     |         |             |   | White           | R-CVCRFBN0013 |         |
|     |         |             |   | Black           | R-CVCRFNR0013 |         |
|     |         |             |   | Neon Yellow     | R-CVCRFGF0013 |         |
|     |         |             |   | Neon Pink       | R-CVCRFFU0013 |         |
| CRF | 450     | 2017 > 2020 | Limited Edition<br>OEM<br>Limited Edition | CR Red /Black   | R-CVCRFRSNR17 | € 59,95 |
|     |         |             |   | CR Red /YZ Blue | R-CVCRFRSBL17 |         |
|     |         |             |   | CR Red          | R-CVCRFRS0017 |         |
|     |         |             |   | White           | R-CVCRFBN0017 |         |
|     |         |             |   | Black           | R-CVCRFNR0017 |         |
|     |         |             |   | Neon Yellow     | R-CVCRFGF0017 |         |
|     |         |             |   | Quantum Grey    | R-CVCRFGR0017 |         |

# HONDA RADIATOR SHROUDS / CONVOGLIATORI ARIA RADIATORE

**OEM** original color -  fluorescent color

| MOD         | CC  | YEAR        | NOTES                  | COLOR           |   | CODE          | PRICE   |
|-------------|-----|-------------|------------------------|-----------------|---|---------------|---------|
| CRF/CRF-RWE | 450 | 2021 > 2023 | OEM                    | CR Red          |    | R-CVCRFRS0021 | € 59,95 |
|             |     |             |                        | White           |    | R-CVCRFBN0021 |         |
|             |     |             |                        | Black           |    | R-CVCRFNR0021 |         |
|             |     |             |                        | Quantum Grey    |    | R-CVCRFGR0021 |         |
|             |     |             |                        | CR Red /Black   |    | R-CVCRFRSNR17 |         |
| CRF-RWE     | 450 | 2019-2020   | OEM<br>Limited Edition | CR Red /YZ Blue |    | R-CVCRFRSBL17 | € 59,95 |
|             |     |             |                        | CR Red          |    | R-CVCRFRS0017 |         |
|             |     |             |                        | White           |    | R-CVCRFBN0017 |         |
|             |     |             |                        | Black           |    | R-CVCRFNR0017 |         |
|             |     |             |                        | Neon Yellow     |    | R-CVCRFGF0017 |         |
|             |     |             |                        | Quantum Grey    |    | R-CVCRFGR0017 |         |
|             |     |             |                        | CR Red          |    | R-CVCRFRS0004 |         |
| CRFX        | 250 | 2004 > 2019 | OEM                    | White           |    | R-CVCRFBN0004 | € 57,95 |
|             |     |             |                        | Black           |    | R-CVCRFNR0004 |         |
|             |     |             |                        | CR Red          |    | R-CVCRFXRS005 |         |
| CRFX        | 450 | 2005 > 2007 | OEM                    | White           |    | R-CVCRFXBN005 | € 57,95 |
|             |     |             |                        | Black           |    | R-CVCRFXNR005 |         |
|             |     |             |                        | CR Red          |    | R-CVCRFXRS008 |         |
| CRFX        | 450 | 2008 > 2017 | OEM                    | White           |    | R-CVCRFXBN008 | € 57,95 |
|             |     |             |                        | Black           |    | R-CVCRFXNR008 |         |
|             |     |             |                        | CR Red /Black   |    | R-CVCRFRSNR97 |         |
| CRFX        | 450 | 2019 > 2023 | OEM                    | CR Red          |    | R-CVCRFRS0097 | € 65,95 |
|             |     |             |                        | White           |   | R-CVCRFBN0097 |         |
|             |     |             |                        | Black           |  | R-CVCRFNR0097 |         |
|             |     |             |                        | CR Red /Black   |  | R-CVCRFRSNR97 |         |
| CRF-RX      | 250 | 2019 > 2021 | OEM                    | CR Red          |  | R-CVCRFRS0097 | € 65,95 |
|             |     |             |                        | White           |  | R-CVCRFBN0097 |         |
|             |     |             |                        | Black           |  | R-CVCRFNR0097 |         |
|             |     |             |                        | CR Red /Black   |  | R-CVCRFRSNR97 |         |
| CRF-RX      | 450 | 2017 > 2020 | OEM                    | CR Red          |  | R-CVCRFRS0097 | € 65,95 |
|             |     |             |                        | White           |  | R-CVCRFBN0097 |         |
|             |     |             |                        | Black           |  | R-CVCRFNR0097 |         |
|             |     |             |                        | CR Red /Black   |  | R-CVCRFRSNR97 |         |



R-CVCRFRSNR17



R-CVCRFXNR008



R-FICRFUPRS21



R-FICRFUPGR21



R-FICRFUPNR21



R-FICRFLONR21



R-FICRFUPBN21

## AVAILABLE COLORS

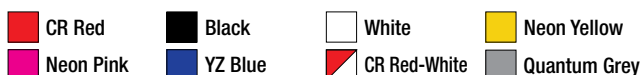

**OEM** original color - fluorescent color

| MOD                | CC      | YEAR        | NOTES   | COLOR        | CODE          | PRICE   |
|--------------------|---------|-------------|---|--------------|---------------|---------|
| CR                 | 85      | 2003 > 2007 | OEM   | White        | R-FICROBN0085 | € 49,95 |
| CRF                | 150     | 2007 > 2023 | OEM 2007 > 2021<br>OEM 2022   | White        | R-FICRFBN0150 | € 49,95 |
|                    |         |             |   | CR Red       | R-FICRFRS0150 |         |
|                    |         |             |   | Black        | R-FICRFNR0150 |         |
|                    |         |             |   | White        | R-FICROBN0001 | € 57,95 |
| CR                 | 125-250 | 2000-2001   | OEM   | White        | R-FICROBN0203 | € 57,95 |
| CR                 | 125-250 | 2002 > 2007 | OEM   | CR Red       | R-FICRORS0203 |         |
|                    |         |             |   | Black        | R-FICRONR0203 |         |
| CRF                | 250     | 2004-2005   | OEM Bi-Color  | White-CR Red | R-FICRFBNRS04 | € 65,95 |
|                    |         |             |   | White        | R-FICRFBN0004 | € 57,95 |
|                    |         |             |   | CR Red       | R-FICRFRS0004 | € 57,95 |
|                    |         |             |   | Black        | R-FICRFNR0004 | € 57,95 |
| CRF                | 250     | 2006 > 2009 | OEM 2009<br>OEM Bi-Color 2006 > 2008                                    | White        | R-FICRFBN0006 | € 57,95 |
|                    |         |             |   | White-CR Red | R-FICRFBNRS06 | € 65,95 |
|                    |         |             |   | CR Red       | R-FICRFRS0006 | € 57,95 |
|                    |         |             |   | Black        | R-FICRFNR0006 | € 57,95 |
| CRF                | 250     | 2010        | OEM   | White        | R-FICRFBN0009 | € 57,95 |
|                    |         |             |   | CR Red       | R-FICRFRS0009 |         |
|                    |         |             |   | Black        | R-FICRFNR0009 |         |
| CRF                | 250     | 2011 > 2013 | OEM - not for USA market<br>not for USA market<br>not for USA market    | White        | R-FICRFBN0011 | € 57,95 |
|                    |         |             |   | CR Red       | R-FICRFRS0011 |         |
|                    |         |             |   | Black        | R-FICRFNR0011 |         |
| CRF<br>mercato USA | 250     | 2011 > 2013 | OEM - for USA market only<br>for USA market only<br>for USA market only | White        | R-FICRFBN0009 | € 57,95 |
|                    |         |             |   | CR Red       | R-FICRFRS0009 |         |
|                    |         |             |   | Black        | R-FICRFNR0009 |         |
| CRF                | 250     | 2014 > 2017 | OEM   | White        | R-FICRFBN0013 | € 43,95 |
|                    |         |             |   | CR Red       | R-FICRFRS0013 |         |
|                    |         |             |   | Black        | R-FICRFNR0013 |         |
|                    |         |             |   | Neon Yellow  | R-FICRFGF0013 |         |
|                    |         |             |   | Neon Pink    | R-FICRFU0013  |         |
|                    |         |             |   | White        | R-FICRFBN0017 | € 54,95 |
|                    |         |             |   | CR Red       | R-FICRFRS0017 |         |
| CRF                | 250     | 2018 > 2021 | Limited Edition<br>OEM  | Black        | R-FICRFNR0017 |         |
|                    |         |             |   | YZ Blue      | R-FICRFBL0017 |         |
|                    |         |             |   | Neon Yellow  | R-FICRFGF0017 |         |
|                    |         |             |   | Quantum Grey | R-FICRFGR0017 |         |
| CRF/CRF-RX         | 250     | 2022-2023   | OEM - Lower side panels   | Black        | R-FICRFLONR21 | € 32,95 |
| CRF/CRF-RX         | 250     | 2022-2023   | OEM - Upper side panels   | CR Red       | R-FICRFUPRS21 | € 59,95 |
|                    |         |             |   | White        | R-FICRFUPBN21 |         |
|                    |         |             |   | Black        | R-FICRFUPNR21 |         |
|                    |         |             |   | Quantum Grey | R-FICRFUPGR21 |         |
| CRF                | 450     | 2002 > 2004 | OEM   | White        | R-FICRFBN0203 | € 57,95 |
|                    |         |             |   | Black        | R-FICRFNR0203 |         |
| CRF                | 450     | 2005-2006   | OEM Bi-Color  | White-CR Red | R-FICRFBNRS05 | € 65,95 |
|                    |         |             |   | White        | R-FICRFBN0005 | € 57,95 |
|                    |         |             |   | CR Red       | R-FICRFRS0005 | € 57,95 |
|                    |         |             |   | Black        | R-FICRFNR0005 | € 57,95 |
| CRF                | 450     | 2007-2008   | OEM Bi-Color  | White-CR Red | R-FICRFBNRS07 | € 65,95 |
|                    |         |             |   | White        | R-FICRFBN0007 | € 57,95 |
|                    |         |             |   | CR Red       | R-FICRFRS0007 | € 57,95 |
|                    |         |             |   | Black        | R-FICRFNR0007 | € 57,95 |

# HONDA SIDE PANELS / TABELLE LATERALI PORTANUMERO



R-FICRFFU0013



R-FICRFGF0013

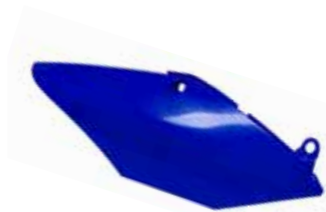

R-FICRFBLO017



R-FICRFGRO017

**OEM** original color - fluorescent color

| MOD               | CC  | YEAR        | NOTES  | COLOR        |  | CODE          | PRICE   |         |
|-------------------|-----|-------------|--|--------------|--|---------------|---------|---------|
| CRF               | 450 | 2009-2010   | OEM  | White        |  | R-FICRFBN0009 | € 57,95 |         |
|                   |     |             |  | CR Red       |  | R-FICRFRS0009 |         |         |
|                   |     |             |  | Black        |  | R-FICRFNR0009 |         |         |
| CRF<br>USA market | 450 | 2009 > 2012 | OEM - for USA market only<br>for USA market only               | White        |  | R-FICRFBN0009 | € 57,95 |         |
|                   |     |             |  | CR Red       |  | R-FICRFRS0009 |         |         |
|                   |     |             |  | Black        |  | R-FICRFNR0009 |         |         |
| CRF               | 450 | 2011-2012   | OEM - not for USA market<br>not for USA market                 | White        |  | R-FICRFBN0011 | € 57,95 |         |
|                   |     |             |  | CR Red       |  | R-FICRFRS0011 |         |         |
|                   |     |             |  | Black        |  | R-FICRFNR0011 |         |         |
| CRF               | 450 | 2013 > 2016 | OEM  | White        |  | R-FICRFBN0013 | € 43,95 |         |
|                   |     |             |  | CR Red       |  | R-FICRFRS0013 |         |         |
|                   |     |             |  | Black        |  | R-FICRFNR0013 |         |         |
|                   |     |             |  | Neon Yellow  |  | R-FICRFGF0013 |         |         |
|                   |     |             |  | Neon Pink    |  | R-FICRFFU0013 |         |         |
|                   |     |             |  | White        |  | R-FICRFXBN004 |         | € 57,95 |
| CRFX              | 250 | 2004 > 2019 | Limited Edition<br>OEM 2009 > 2019<br>OEM Bi-Color 2004 > 2008 | White-CR Red |  | R-FICRFXBNRS4 | € 65,95 |         |
|                   |     |             |  | CR Red       |  | R-FICRFXRS004 | € 57,95 |         |
|                   |     |             |  | Black        |  | R-FICRFXNR004 | € 57,95 |         |
|                   |     |             |  | White        |  | R-FICRFXBN005 | € 57,95 |         |
| CRFX              | 450 | 2005 > 2017 | OEM 2009 > 2017  | CR Red       |  | R-FICRFXRS005 | € 57,95 |         |
|                   |     |             |  | Black        |  | R-FICRFXNR005 |         |         |
|                   |     |             |  | White        |  | R-FICRFBN0017 |         | € 54,95 |
|                   |     |             |  | CR Red       |  | R-FICRFRS0017 |         |         |
|                   |     |             |  | Black        |  | R-FICRFNR0017 |         |         |
| CRF               | 450 | 2017 > 2020 | OEM  | YZ Blue      |  | R-FICRFBLO017 | € 54,95 |         |
|                   |     |             |  | Neon Yellow  |  | R-FICRFGF0017 |         |         |
|                   |     |             |  | Quantum Grey |  | R-FICRFGRO017 |         |         |
|                   |     |             |  | Black        |  | R-FICRFLONR21 |         | € 32,95 |
|                   |     |             |  | CR Red       |  | R-FICRFXRS004 |         | € 59,95 |
| CRF/CRF-RWE       | 450 | 2021 > 2023 | OEM - Lower side panels  | White        |  | R-FICRFXRS004 | € 59,95 |         |
|                   |     |             |  | Black        |  | R-FICRFXNR004 |         |         |
|                   |     |             |  | Quantum Grey |  | R-FICRFXPNR21 |         |         |
|                   |     |             |  | Black        |  | R-FICRFXPNR21 |         |         |
|                   |     |             |  | Quantum Grey |  | R-FICRFXPGR21 |         |         |
| CRFX              | 450 | 2019 > 2023 | OEM  | White        |  | R-FICRFBN0017 | € 54,95 |         |
|                   |     |             |  | CR Red       |  | R-FICRFRS0017 |         |         |
|                   |     |             |  | Black        |  | R-FICRFNR0017 |         |         |
|                   |     |             |  | YZ Blue      |  | R-FICRFBLO017 |         |         |
|                   |     |             |  | Neon Yellow  |  | R-FICRFGF0017 |         |         |
|                   |     |             |  | Quantum Grey |  | R-FICRFGRO017 |         |         |
| CRF-RX            | 250 | 2019 > 2021 | OEM  | White        |  | R-FICRFBN0017 | € 54,95 |         |
|                   |     |             |  | CR Red       |  | R-FICRFRS0017 |         |         |
|                   |     |             |  | Black        |  | R-FICRFNR0017 |         |         |
|                   |     |             |  | YZ Blue      |  | R-FICRFBLO017 |         |         |
|                   |     |             |  | Neon Yellow  |  | R-FICRFGF0017 |         |         |
| CRF-RX            | 450 | 2017 > 2020 | OEM  | Quantum Grey |  | R-FICRFGRO017 | € 54,95 |         |
|                   |     |             |  | White        |  | R-FICRFBN0017 |         |         |
|                   |     |             |  | CR Red       |  | R-FICRFRS0017 |         |         |
|                   |     |             |  | Black        |  | R-FICRFNR0017 |         |         |
|                   |     |             |  | YZ Blue      |  | R-FICRFBLO017 |         |         |
| CRF-RX            | 450 | 2021 > 2023 | OEM - Lower side panels  | Neon Yellow  |  | R-FICRFGF0017 | € 54,95 |         |
|                   |     |             |  | Quantum Grey |  | R-FICRFGRO017 |         |         |
|                   |     |             |  | Black        |  | R-FICRFLONR21 |         | € 32,95 |
|                   |     |             |  | CR Red       |  | R-FICRFXRS004 |         | € 59,95 |
|                   |     |             |  | White        |  | R-FICRFXPNR21 |         |         |
| CRF-RX            | 450 | 2021 > 2023 | OEM - Upper side panels  | Black        |  | R-FICRFXPNR21 | € 59,95 |         |
|                   |     |             |  | Quantum Grey |  | R-FICRFXPGR21 |         |         |
|                   |     |             |  | Black        |  | R-FICRFXPNR21 |         |         |
|                   |     |             |  | Quantum Grey |  | R-FICRFXPGR21 |         |         |
|                   |     |             |  | CR Red       |  | R-FICRFRS0017 |         | € 54,95 |
| CRF-RWE           | 450 | 2019-2020   | OEM  | White        |  | R-FICRFBN0017 | € 54,95 |         |
|                   |     |             |  | Black        |  | R-FICRFNR0017 |         |         |
|                   |     |             |  | YZ Blue      |  | R-FICRFBLO017 |         |         |
|                   |     |             |  | Neon Yellow  |  | R-FICRFGF0017 |         |         |
|                   |     |             |  | Quantum Grey |  | R-FICRFGRO017 |         |         |
|                   |     |             |  | White        |  | R-FICRFBN0017 |         | € 54,95 |

# HONDA AIR BOX COVERS / COPERCHI LATERALI CASSA FILTRO



R-FILCFCRFRS97



R-FILCFCRFBN93

## AVAILABLE COLORS



### OEM original color - fluorescent color

| MOD     | CC  | YEAR        | NOTES  | COLOR        |  | CODE           | PRICE   |
|---------|-----|-------------|--|--------------|--|----------------|---------|
| CRF     | 250 | 2010 > 2013 | OEM  | CR Red       |  | R-FILCFCRFRS9  | € 30,95 |
|         |     |             |  | White        |  | R-FILCFCRFBN9  |         |
|         |     |             |  | Black        |  | R-FILCFCRFNR9  |         |
| CRF     | 250 | 2014 > 2017 | OEM - not for USA market<br>not for USA market<br>not for USA market<br>not for USA market - Limited Edition     | White        |  | R-FILCFCRFBN13 | € 57,95 |
|         |     |             |  | Black        |  | R-FILCFCRFNR13 |         |
|         |     |             |  | CR Red       |  | R-FILCFCRFRS13 |         |
|         |     |             |  | Neon Yellow  |  | R-FILCFCRFGF13 |         |
|         |     |             |  | Neon Pink    |  | R-FILCFCRFFU13 |         |
|         |     |             |  | Quantum Grey |  | R-FILCFCRFBN93 |         |
| CRF     | 250 | 2014 > 2017 | OEM - For USA market only<br>For USA market only<br>For USA market only<br>For USA market only - Limited Edition | White        |  | R-FILCFCRFBN93 | € 57,95 |
|         |     |             |  | Black        |  | R-FILCFCRFNR93 |         |
|         |     |             |  | CR Red       |  | R-FILCFCRFRS93 |         |
|         |     |             |  | Neon Pink    |  | R-FILCFCRFFU93 |         |
| CRF     | 250 | 2018 > 2021 | OEM  | CR Red       |  | R-FILCFCRFRS97 | € 57,95 |
|         |     |             |  | White        |  | R-FILCFCRFBN97 |         |
|         |     |             |  | Black        |  | R-FILCFCRFNR97 |         |
|         |     |             |  | Neon Yellow  |  | R-FILCFCRFGF97 |         |
|         |     |             |  | Quantum Grey |  | R-FILCFCRFBN97 |         |
|         |     |             |  | CR Red       |  | R-FILCFCRFRS9  |         |
| CRF     | 450 | 2009 > 2012 | Limited Edition<br>OEM   | CR Red       |  | R-FILCFCRFRS9  | € 30,95 |
|         |     |             |  | White        |  | R-FILCFCRFBN9  |         |
|         |     |             |  | Black        |  | R-FILCFCRFNR9  |         |
| CRF     | 450 | 2013 > 2016 | OEM - not for USA market<br>not for USA market<br>not for USA market<br>not for USA market - Limited Edition     | White        |  | R-FILCFCRFBN13 | € 57,95 |
|         |     |             |  | Black        |  | R-FILCFCRFNR13 |         |
|         |     |             |  | CR Red       |  | R-FILCFCRFRS13 |         |
|         |     |             |  | Neon Yellow  |  | R-FILCFCRFGF13 |         |
|         |     |             |  | Neon Pink    |  | R-FILCFCRFFU13 |         |
|         |     |             |  | Quantum Grey |  | R-FILCFCRFBN93 |         |
| CRF     | 450 | 2013 > 2016 | OEM - For USA market only<br>For USA market only<br>For USA market only<br>For USA market only - Limited Edition | White        |  | R-FILCFCRFBN93 | € 57,95 |
|         |     |             |  | Black        |  | R-FILCFCRFNR93 |         |
|         |     |             |  | CR Red       |  | R-FILCFCRFRS93 |         |
|         |     |             |  | Neon Pink    |  | R-FILCFCRFFU93 |         |
| CRF     | 450 | 2017 > 2020 | OEM  | CR Red       |  | R-FILCFCRFRS97 | € 57,95 |
|         |     |             |  | White        |  | R-FILCFCRFBN97 |         |
|         |     |             |  | Black        |  | R-FILCFCRFNR97 |         |
|         |     |             |  | Neon Yellow  |  | R-FILCFCRFGF97 |         |
|         |     |             |  | Quantum Grey |  | R-FILCFCRFBN97 |         |
|         |     |             |  | CR Red       |  | R-FILCFCRFRS9  |         |
| CRFX    | 450 | 2019 > 2023 | Limited Edition<br>OEM   | CR Red       |  | R-FILCFCRFRS97 | € 57,95 |
|         |     |             |  | White        |  | R-FILCFCRFBN97 |         |
|         |     |             |  | Black        |  | R-FILCFCRFNR97 |         |
|         |     |             |  | Neon Yellow  |  | R-FILCFCRFGF97 |         |
|         |     |             |  | Quantum Grey |  | R-FILCFCRFBN97 |         |
|         |     |             |  | CR Red       |  | R-FILCFCRFRS97 |         |
| CRF-RX  | 250 | 2019 > 2021 | Limited Edition<br>OEM   | CR Red       |  | R-FILCFCRFRS97 | € 57,95 |
|         |     |             |  | White        |  | R-FILCFCRFBN97 |         |
|         |     |             |  | Black        |  | R-FILCFCRFNR97 |         |
|         |     |             |  | Neon Yellow  |  | R-FILCFCRFGF97 |         |
|         |     |             |  | Quantum Grey |  | R-FILCFCRFBN97 |         |
|         |     |             |  | CR Red       |  | R-FILCFCRFRS97 |         |
| CRF-RX  | 450 | 2017 > 2020 | Limited Edition<br>OEM   | CR Red       |  | R-FILCFCRFRS97 | € 57,95 |
|         |     |             |  | White        |  | R-FILCFCRFBN97 |         |
|         |     |             |  | Black        |  | R-FILCFCRFNR97 |         |
|         |     |             |  | Neon Yellow  |  | R-FILCFCRFGF97 |         |
|         |     |             |  | Quantum Grey |  | R-FILCFCRFBN97 |         |
|         |     |             |  | CR Red       |  | R-FILCFCRFRS97 |         |
| CRF-RWE | 450 | 2019-2020   | Limited Edition<br>OEM   | CR Red       |  | R-FILCFCRFRS97 | € 57,95 |
|         |     |             |  | White        |  | R-FILCFCRFBN97 |         |
|         |     |             |  | Black        |  | R-FILCFCRFNR97 |         |
|         |     |             |  | Neon Yellow  |  | R-FILCFCRFGF97 |         |
|         |     |             |  | Quantum Grey |  | R-FILCFCRFBN97 |         |
|         |     |             |  | CR Red       |  | R-FILCFCRFRS97 |         |
| CRF-RWE | 450 | 2019-2020   | Limited Edition  | CR Red       |  | R-FILCFCRFRS97 | € 57,95 |
|         |     |             |  | White        |  | R-FILCFCRFBN97 |         |
|         |     |             |  | Black        |  | R-FILCFCRFNR97 |         |
|         |     |             |  | Neon Yellow  |  | R-FILCFCRFGF97 |         |

# HONDA RADIATOR LOUVERS / GRIGLIE RADIATORE



Total protection of the bottom part of the stock radiator, it fully covers the part that with the standard louver remains without a shield against ground and stones.

*Protezione totale della parte inferiore del radiatore di serie. Copre integralmente la vaschetta che nella versione standard rimane invece esposta agli urti di terra e sassi.*



## AVAILABLE COLORS

- CR Red
- Black
- White
- Neon Yellow

**OEM** original color - ☀️ fluorescent color

| MOD                   | CC  | YEAR        | NOTES                          | COLOR       | CODE   | PRICE   |
|-----------------------|-----|-------------|--------------------------------|-------------|--|---------|
| CRF                   | 250 | 2018-2019   | Oversize for original radiator | Black       | <span style="display: inline-block; width: 15px; height: 15px; background-color: black; margin-right: 5px;"></span> R-GRCRFNR0018  | € 36,95 |
|                       |     |             |                                | CR Red      | <span style="display: inline-block; width: 15px; height: 15px; background-color: red; margin-right: 5px;"></span> R-GRCRFRS0018    |         |
|                       |     |             |                                | Neon Yellow | <span style="display: inline-block; width: 15px; height: 15px; background-color: yellow; margin-right: 5px;"></span> R-GRCRFGF0018 |         |
|                       |     |             |                                | White       | <span style="display: inline-block; width: 15px; height: 15px; background-color: white; margin-right: 5px;"></span> R-GRCRFBN0018  |         |
| CRF                   | 250 | 2020-2021   | Oversize for original radiator | Black       | <span style="display: inline-block; width: 15px; height: 15px; background-color: black; margin-right: 5px;"></span> R-GRCRFNR0020  | € 36,95 |
|                       |     |             |                                | CR Red      | <span style="display: inline-block; width: 15px; height: 15px; background-color: red; margin-right: 5px;"></span> R-GRCRFRS0020    |         |
|                       |     |             |                                | Neon Yellow | <span style="display: inline-block; width: 15px; height: 15px; background-color: yellow; margin-right: 5px;"></span> R-GRCRFGF0020 |         |
|                       |     |             |                                | White       | <span style="display: inline-block; width: 15px; height: 15px; background-color: white; margin-right: 5px;"></span> R-GRCRFBN0020  |         |
| CRF-RX                | 250 | 2019        | Oversize for original radiator | Black       | <span style="display: inline-block; width: 15px; height: 15px; background-color: black; margin-right: 5px;"></span> R-GRCRFNR0018  | € 36,95 |
|                       |     |             |                                | CR Red      | <span style="display: inline-block; width: 15px; height: 15px; background-color: red; margin-right: 5px;"></span> R-GRCRFRS0018    |         |
|                       |     |             |                                | Neon Yellow | <span style="display: inline-block; width: 15px; height: 15px; background-color: yellow; margin-right: 5px;"></span> R-GRCRFGF0018 |         |
|                       |     |             |                                | White       | <span style="display: inline-block; width: 15px; height: 15px; background-color: white; margin-right: 5px;"></span> R-GRCRFBN0018  |         |
| CRF-RX                | 250 | 2020-2021   | Oversize for original radiator | Black       | <span style="display: inline-block; width: 15px; height: 15px; background-color: black; margin-right: 5px;"></span> R-GRCRFNR0020  | € 36,95 |
|                       |     |             |                                | CR Red      | <span style="display: inline-block; width: 15px; height: 15px; background-color: red; margin-right: 5px;"></span> R-GRCRFRS0020    |         |
|                       |     |             |                                | Neon Yellow | <span style="display: inline-block; width: 15px; height: 15px; background-color: yellow; margin-right: 5px;"></span> R-GRCRFGF0020 |         |
|                       |     |             |                                | White       | <span style="display: inline-block; width: 15px; height: 15px; background-color: white; margin-right: 5px;"></span> R-GRCRFBN0020  |         |
| CRF/CRF-RX            | 250 | 2022-2023   | For original radiator          | Black       | <span style="display: inline-block; width: 15px; height: 15px; background-color: black; margin-right: 5px;"></span> R-GRCRFNR0021  | € 36,95 |
|                       |     |             |                                | CR Red      | <span style="display: inline-block; width: 15px; height: 15px; background-color: red; margin-right: 5px;"></span> R-GRCRFRS0021    |         |
|                       |     |             |                                | White       | <span style="display: inline-block; width: 15px; height: 15px; background-color: white; margin-right: 5px;"></span> R-GRCRFBN0021  |         |
| CRF / CRF-RX          | 450 | 2017 > 2020 | Oversize for original radiator | Black       | <span style="display: inline-block; width: 15px; height: 15px; background-color: black; margin-right: 5px;"></span> R-GRCRFNR0017  | € 36,95 |
|                       |     |             |                                | CR Red      | <span style="display: inline-block; width: 15px; height: 15px; background-color: red; margin-right: 5px;"></span> R-GRCRFRS0017    |         |
|                       |     |             |                                | Neon Yellow | <span style="display: inline-block; width: 15px; height: 15px; background-color: yellow; margin-right: 5px;"></span> R-GRCRFGF0017 |         |
|                       |     |             |                                | White       | <span style="display: inline-block; width: 15px; height: 15px; background-color: white; margin-right: 5px;"></span> R-GRCRFBN0017  |         |
| CRF/CRF-RWE<br>CRF-RX | 450 | 2021 > 2023 | For original radiator          | Black       | <span style="display: inline-block; width: 15px; height: 15px; background-color: black; margin-right: 5px;"></span> R-GRCRFNR0021  | € 36,95 |
|                       |     |             |                                | CR Red      | <span style="display: inline-block; width: 15px; height: 15px; background-color: red; margin-right: 5px;"></span> R-GRCRFRS0021    |         |
|                       |     |             |                                | White       | <span style="display: inline-block; width: 15px; height: 15px; background-color: white; margin-right: 5px;"></span> R-GRCRFBN0021  |         |
| CRF-RWE               | 450 | 2019-2020   | Oversize for original radiator | Black       | <span style="display: inline-block; width: 15px; height: 15px; background-color: black; margin-right: 5px;"></span> R-GRCRFNR0017  | € 36,95 |
|                       |     |             |                                | CR Red      | <span style="display: inline-block; width: 15px; height: 15px; background-color: red; margin-right: 5px;"></span> R-GRCRFRS0017    |         |
|                       |     |             |                                | Neon Yellow | <span style="display: inline-block; width: 15px; height: 15px; background-color: yellow; margin-right: 5px;"></span> R-GRCRFGF0017 |         |
|                       |     |             |                                | White       | <span style="display: inline-block; width: 15px; height: 15px; background-color: white; margin-right: 5px;"></span> R-GRCRFBN0017  |         |



# HONDA FRONT NUMBER PLATE / TABELLA PORTANUMERO ANTERIORE



R-TBCRFRS0021



R-TBCRFBN0021



R-TBCRFGRO021



R-TBCRFNR0021



R-TBCRFBLO019



R-TBCRFGF0019

**NEON**

## AVAILABLE COLORS



**OEM** original color - fluorescent color

| MOD        | CC          | YEAR        | NOTES           | COLOR           |              | CODE          | PRICE         |         |
|------------|-------------|-------------|-----------------|-----------------|--------------|---------------|---------------|---------|
| CR         | 80          | 1996 > 2002 | OEM             | White           |              | R-TBCROBN0085 | € 23,95       |         |
| CR         | 85          | 2003 > 2007 | OEM             | White           |              | R-TBCROBN0085 | € 23,95       |         |
| CRF        | 150         | 2007 > 2023 | OEM 2007>2021   | White           |              | R-TBCRFBN0150 | € 23,95       |         |
|            |             |             |                 | Black           |              | R-TBCRFNR0150 |               |         |
| CR/CRF     | 125-250-450 | 2004 > 2007 | OEM             | CR Red          |              | R-TBCRFRS0150 |               |         |
|            |             |             |                 | White           |              | R-TBCROBN0004 | € 28,95       |         |
|            |             |             |                 | Black           |              | R-TBCRONR0004 |               |         |
| CR         | 125-250-500 | 2000 > 2003 | OEM             | CR Red          |              | R-TBCRORS0004 |               |         |
|            |             |             |                 | White           |              | R-TBCROBN0003 | € 28,95       |         |
|            |             |             |                 | Black           |              | R-TBCRFNR0008 | € 28,95       |         |
| CRF        | 250         | 2008-2009   | OEM             | CR Red          |              | R-TBCRFRS0008 |               |         |
|            |             |             |                 | White           |              | R-TBCRFBN0009 | € 28,95       |         |
|            |             |             |                 | Black           |              | R-TBCRFNR0009 |               |         |
| CRF        | 250         | 2010 > 2013 | OEM             | CR Red          |              | R-TBCRFRS0009 |               |         |
|            |             |             |                 | White           |              | R-TBCRFBN0013 | € 28,95       |         |
|            |             |             |                 | Black           |              | R-TBCRFNR0013 |               |         |
| CRF        | 250         | 2014 > 2017 | OEM             | CR Red          |              | R-TBCRFRS0013 |               |         |
|            |             |             |                 | Neon Yellow     |              | R-TBCRFGF0013 |               |         |
|            |             |             |                 | Neon Pink       |              | R-TBCRFFU0013 |               |         |
| CRF        | 250         | 2018        | Limited Edition | White           |              | R-TBCRFBN0017 | € 28,95       |         |
|            |             |             | OEM             | Black           |              | R-TBCRFNR0017 |               |         |
|            |             |             | Limited Edition | CR Red          |              | R-TBCRFRS0017 |               |         |
| CRF        | 250         | 2019 > 2021 | OEM             | YZ Blue         |              | R-TBCRFBLO017 |               |         |
|            |             |             |                 | Neon Yellow     |              | R-TBCRFGF0017 |               |         |
|            |             |             |                 | White           |              | R-TBCRFBN0019 | € 28,95       |         |
| CRF        | 250         | 2019 > 2021 | OEM             | Black           |              | R-TBCRFNR0019 |               |         |
|            |             |             |                 | CR Red          |              | R-TBCRFRS0019 |               |         |
|            |             |             |                 | Limited Edition | YZ Blue      |               | R-TBCRFBLO019 |         |
| CRF/CRF-RX | 250         | 2022-2023   | OEM             | Neon Yellow     |              | R-TBCRFGF0019 |               |         |
|            |             |             |                 | Limited Edition | Quantum Grey |               | R-TBCRFGRO019 |         |
|            |             |             |                 | Limited Edition | CR Red       |               | R-TBCRFRS0021 | € 28,95 |
| CRF        | 450         | 2002-2003   | OEM             | White           |              | R-TBCRFBN0021 |               |         |
|            |             |             |                 | Black           |              | R-TBCRFNR0021 |               |         |
|            |             |             |                 | Quantum Grey    |              | R-TBCRFGRO021 |               |         |
| CRF        | 450         | 2008        | OEM             | White           |              | R-TBCROBN0003 | € 28,95       |         |
|            |             |             |                 | Black           |              | R-TBCRFNR0008 | € 28,95       |         |
|            |             |             |                 | CR Red          |              | R-TBCRFRS0008 |               |         |
| CRF        | 450         | 2009 > 2012 | OEM             | CR Red          |              | R-TBCRFRS0008 |               |         |
|            |             |             |                 | White           |              | R-TBCRFBN0009 | € 28,95       |         |
|            |             |             |                 | Black           |              | R-TBCRFNR0009 |               |         |
| CRF        | 450         | 2013 > 2016 | OEM             | CR Red          |              | R-TBCRFRS0009 |               |         |
|            |             |             |                 | White           |              | R-TBCRFBN0013 | € 28,95       |         |
|            |             |             |                 | Black           |              | R-TBCRFNR0013 |               |         |
| CRF        | 450         | 2013 > 2016 | OEM             | CR Red          |              | R-TBCRFRS0013 |               |         |
|            |             |             |                 | Neon Yellow     |              | R-TBCRFGF0013 |               |         |
|            |             |             |                 | Limited Edition | Neon Pink    |               | R-TBCRFFU0013 |         |

# HONDA FRONT NUMBER PLATE / TABELLA PORTANUMERO ANTERIORE

**OEM** original color - ☀ fluorescent color

| MOD        | CC  | YEAR        | NOTES | COLOR        | CODE          | PRICE   |
|------------|-----|-------------|-------|--------------|---------------|---------|
| CRF/CRF-RX | 450 | 2017-2018   | OEM   | White        | R-TBCRFBN0017 | € 28,95 |
|            |     |             |       | Black        | R-TBCRFNR0017 |         |
|            |     |             |       | CR Red       | R-TBCRFRS0017 |         |
|            |     |             |       | YZ Blue      | R-TBCRFBL0017 |         |
|            |     |             |       | Neon Yellow  | R-TBCRFGF0017 |         |
| CRF        | 450 | 2019-2020   | OEM   | White        | R-TBCRFBN0019 | € 28,95 |
|            |     |             |       | Black        | R-TBCRFNR0019 |         |
|            |     |             |       | CR Red       | R-TBCRFRS0019 |         |
|            |     |             |       | YZ Blue      | R-TBCRFBL0019 |         |
|            |     |             |       | Neon Yellow  | R-TBCRFGF0019 |         |
| CRF/CRF-RX | 450 | 2021 > 2023 | OEM   | Quantum Grey | R-TBCRFGR0019 | € 28,95 |
|            |     |             |       | CR Red       | R-TBCRFRS0021 |         |
|            |     |             |       | White        | R-TBCRFBN0021 |         |
|            |     |             |       | Black        | R-TBCRFNR0021 |         |
|            |     |             |       | Quantum Grey | R-TBCRFGR0021 |         |
| CRF-RX     | 250 | 2019 > 2021 | OEM   | White        | R-TBCRFBN0019 | € 28,95 |
|            |     |             |       | Black        | R-TBCRFNR0019 |         |
|            |     |             |       | CR Red       | R-TBCRFRS0019 |         |
|            |     |             |       | YZ Blue      | R-TBCRFBL0019 |         |
|            |     |             |       | Neon Yellow  | R-TBCRFGF0019 |         |
| CRF-RX     | 450 | 2019-2020   | OEM   | Quantum Grey | R-TBCRFGR0019 | € 28,95 |
|            |     |             |       | White        | R-TBCRFBN0019 |         |
|            |     |             |       | Black        | R-TBCRFNR0019 |         |
|            |     |             |       | CR Red       | R-TBCRFRS0019 |         |
|            |     |             |       | YZ Blue      | R-TBCRFBL0019 |         |
| CRF-RX     | 450 | 2019-2020   | OEM   | Neon Yellow  | R-TBCRFGF0019 | € 28,95 |
|            |     |             |       | Quantum Grey | R-TBCRFGR0019 |         |
|            |     |             |       | White        | R-TBCRFBN0019 |         |
|            |     |             |       | Black        | R-TBCRFNR0019 |         |
|            |     |             |       | YZ Blue      | R-TBCRFBL0019 |         |
| CRF-RWE    | 450 | 2019-2020   | OEM   | CR Red       | R-TBCRFRS0019 | € 28,95 |
|            |     |             |       | White        | R-TBCRFBN0019 |         |
|            |     |             |       | Black        | R-TBCRFNR0019 |         |
|            |     |             |       | YZ Blue      | R-TBCRFBL0019 |         |
|            |     |             |       | Neon Yellow  | R-TBCRFGF0019 |         |
| CRF-RX     | 450 | 2019-2020   | OEM   | Quantum Grey | R-TBCRFGR0019 | € 28,95 |
|            |     |             |       | White        | R-TBCRFBN0019 |         |
|            |     |             |       | Black        | R-TBCRFNR0019 |         |
|            |     |             |       | YZ Blue      | R-TBCRFBL0019 |         |
|            |     |             |       | Neon Yellow  | R-TBCRFGF0019 |         |

# HONDA FRONT NUMBER PLATE / TABELLA PORTANUMERO ANTERIORE



**OEM** original color

| MOD        | CC  | YEAR        | NOTES                                   | COLOR        | CODE          | PRICE   |
|------------|-----|-------------|---|--------------|---------------|---------|
| CRF/CRF-RX | 250 | 2022-2023   | OEM - <b>FACTORY</b> front number plate | CR Red       | R-TBCRFRS0022 | € 38,95 |
|            |     |             |   | White        | R-TBCRFBN0022 |         |
|            |     |             |   | Black        | R-TBCRFNR0022 |         |
|            |     |             |   | Quantum Grey | R-TBCRFGR0022 |         |
| CRF/CRF-RX | 450 | 2021 > 2023 | OEM - <b>FACTORY</b> front number plate | CR Red       | R-TBCRFRS0022 | € 38,95 |
|            |     |             |   | White        | R-TBCRFBN0022 |         |
|            |     |             |   | Black        | R-TBCRFNR0022 |         |
|            |     |             |   | Quantum Grey | R-TBCRFGR0022 |         |

# HONDA FORK PROTECTORS / PARASTELI FORCELLA

 **NEON**



R-PSCRFRS0019

R-PSCRFBN0019

R-PSCRFN0019





















































R-PSCRFGF0019

R-PSCRFB0019

## AVAILABLE COLORS

-  CR Red
-  Black
-  White
-  YZ Blue
-  Neon Pink
-  Neon Yellow
-  Quantum Grey
-  Neutral

**OEM** original color -  fluorescent color

| MOD          | CC          | YEAR        | NOTES                                 | COLOR   |   | CODE          | PRICE   |
|--------------|-------------|-------------|---------------------------------------|---------|---|---------------|---------|
| CR           | 85          | 2003 > 2007 | OEM                                   | Neutral |    | R-PSCRNT0150  | € 28,95 |
|              |             |             |                                       | White   |    | R-PSCRBN0150  |         |
|              |             |             |                                       | Black   |    | R-PSCRNR0150  |         |
|              |             |             |                                       | CR Red  |    | R-PSCFRS0150  |         |
|              |             |             |                                       | CR Red  |    | R-PSCFRS0150  |         |
| CRF          | 150         | 2007 > 2023 | OEM 2019 > 2023<br>OEM 2007 > 2018    | CR Red  |    | R-PSCFRS0150  | € 28,95 |
|              |             |             |                                       | Neutral |    | R-PSCRNT0150  |         |
|              |             |             |                                       | White   |    | R-PSCRBN0150  |         |
|              |             |             |                                       | Black   |  | R-PSCRNR0150  |         |
|              |             |             |                                       | Black   |  | R-PSCRNR0150  |         |
| CR           | 125-250-500 | 1990 > 2007 | OEM                                   | Neutral |   | R-PSCRNT0003  | € 34,95 |
|              |             |             |                                       | White   |  | R-PSCRBN0003  |         |
|              |             |             |                                       | Black   |  | R-PSCRNR0003  |         |
|              |             |             |                                       | CR Red  |  | R-PSCRORS0003 |         |
|              |             |             |                                       | CR Red  |  | R-PSCRORS0003 |         |
| CRF          | 250         | 2004 > 2018 | OEM 2017-2018<br>OEM 2004 > 2016      | CR Red  |  | R-PSCRORS0003 | € 34,95 |
|              |             |             |                                       | Neutral |  | R-PSCRNT0003  |         |
|              |             |             |                                       | White   |  | R-PSCRBN0003  |         |
|              |             |             |                                       | Black   |  | R-PSCRNR0003  |         |
|              |             |             |                                       | Black   |  | R-PSCRNR0003  |         |
| CRF          | 450         | 2002 > 2018 | OEM 2017-2018<br>OEM 2002 > 2016      | CR Red  |  | R-PSCRORS0003 | € 34,95 |
|              |             |             |                                       | Neutral |  | R-PSCRNT0003  |         |
|              |             |             |                                       | White   |  | R-PSCRBN0003  |         |
|              |             |             |                                       | Black   |  | R-PSCRNR0003  |         |
|              |             |             |                                       | Black   |  | R-PSCRNR0003  |         |
| CRF-RX       | 450         | 2017-2018   | without tachimeter cable guide<br>OEM | CR Red  |  | R-PSCRORS0003 | € 34,95 |
|              |             |             |                                       | Neutral |  | R-PSCRNT0003  |         |
|              |             |             |                                       | White   |  | R-PSCRBN0003  |         |
|              |             |             |                                       | Black   |  | R-PSCRNR0003  |         |
|              |             |             |                                       | Black   |  | R-PSCRNR0003  |         |
| CRFX         | 250         | 2004 > 2019 | without tachimeter cable guide<br>OEM | CR Red  |  | R-PSCRORS0003 | € 34,95 |
|              |             |             |                                       | Neutral |  | R-PSCRNT0003  |         |
|              |             |             |                                       | White   |  | R-PSCRBN0003  |         |
|              |             |             |                                       | Black   |  | R-PSCRNR0003  |         |
|              |             |             |                                       | Black   |  | R-PSCRNR0003  |         |
| CRFX         | 450         | 2005 > 2017 | without tachimeter cable guide<br>OEM | CR Red  |  | R-PSCRORS0003 | € 34,95 |
|              |             |             |                                       | Neutral |  | R-PSCRNT0003  |         |
|              |             |             |                                       | White   |  | R-PSCRBN0003  |         |
|              |             |             |                                       | Black   |  | R-PSCRNR0003  |         |
|              |             |             |                                       | Black   |  | R-PSCRNR0003  |         |
| CRF/CRF-RWE  | 250-450     | 2019 > 2023 | OEM                                   | CR Red  |  | R-PSCFRS0019  | € 34,95 |
|              |             |             |                                       | White   |  | R-PSCRFBN0019 |         |
|              |             |             |                                       | Black   |  | R-PSCRFN0019  |         |
|              |             |             |                                       | YZ Blue |  | R-PSCRFB0019  |         |
|              |             |             |                                       | YZ Blue |  | R-PSCRFB0019  |         |
| CRF-RX       | 250-450     | 2019 > 2023 | OEM                                   | CR Red  |  | R-PSCFRS0019  | € 34,95 |
|              |             |             |                                       | White   |  | R-PSCRFBN0019 |         |
|              |             |             |                                       | Black   |  | R-PSCRFN0019  |         |
|              |             |             |                                       | YZ Blue |  | R-PSCRFB0019  |         |
|              |             |             |                                       | YZ Blue |  | R-PSCRFB0019  |         |
| CRFX / CRF-L | 450         | 2019 > 2023 | OEM                                   | CR Red  |  | R-PSCFRS0019  | € 34,95 |
|              |             |             |                                       | White   |  | R-PSCRFBN0019 |         |
|              |             |             |                                       | Black   |  | R-PSCRFN0019  |         |
|              |             |             |                                       | YZ Blue |  | R-PSCRFB0019  |         |
|              |             |             |                                       | YZ Blue |  | R-PSCRFB0019  |         |

# HONDA REAR SHOCK MUD FLAP / PARASPRUZZI MONOAMMORTIZZATORE



## AVAILABLE COLORS

- CR Red
- Black
- Neutral



R-PSPCRFNR017



R-PSPCRFRS017

| MOD                    | CC      | YEAR        | NOTES | COLOR   | CODE          | PRICE   |
|------------------------|---------|-------------|-------|---------|---------------|---------|
| CRF                    | 150     | 2007 > 2023 | OEM   | Black   | R-PSPCRFNR150 | € 18,95 |
|                        |         |             |       | Neutral | R-PSPCRFNT150 |         |
| CR                     | 125-500 | 1993 > 2007 |       | Black   | R-PSPCR0NR000 | € 18,95 |
|                        |         |             |       | Neutral | R-PSPCR0NT000 |         |
| CR                     | 250     | 1992 > 2007 |       | Black   | R-PSPCR0NR000 | € 18,95 |
|                        |         |             |       | Neutral | R-PSPCR0NT000 |         |
| CRF                    | 250     | 2006 > 2009 |       | Black   | R-PSPCRFNR006 | € 18,95 |
|                        |         |             |       | Neutral | R-PSPCRFNT006 |         |
| CRF                    | 250     | 2010 > 2013 |       | Black   | R-PSPCR0NR000 | € 18,95 |
|                        |         |             |       | Neutral | R-PSPCR0NT000 |         |
| CRF                    | 250     | 2014 > 2017 |       | Black   | R-PSPCRFNR013 | € 18,95 |
|                        |         |             |       | CR Red  | R-PSPCRFRS013 |         |
| CRF                    | 250     | 2018 > 2021 |       | Black   | R-PSPCRFNR017 | € 18,95 |
|                        |         |             |       | CR Red  | R-PSPCRFRS017 |         |
|                        |         |             |       | Black   | R-PSPCRFNR021 |         |
|                        |         |             |       | CR Red  | R-PSPCRFRS021 |         |
| CRF                    | 450     | 2002 > 2012 |       | Black   | R-PSPCR0NR000 | € 18,95 |
|                        |         |             |       | Neutral | R-PSPCR0NT000 |         |
|                        |         |             |       | Black   | R-PSPCRFNR013 |         |
|                        |         |             |       | CR Red  | R-PSPCRFRS013 |         |
| CRF / CRF-RX           | 450     | 2017 > 2020 |       | Black   | R-PSPCRFNR017 | € 18,95 |
|                        |         |             |       | CR Red  | R-PSPCRFRS017 |         |
|                        |         |             |       | Black   | R-PSPCR0NR000 |         |
|                        |         |             |       | Neutral | R-PSPCR0NT000 |         |
| CRFX                   | 450     | 2005 > 2017 |       | Black   | R-PSPCR0NR000 | € 18,95 |
|                        |         |             |       | Neutral | R-PSPCR0NT000 |         |
|                        |         |             |       | Black   | R-PSPCRFNR017 |         |
|                        |         |             |       | CR Red  | R-PSPCRFRS017 |         |
| CRF-RX                 | 250     | 2019 > 2021 |       | Black   | R-PSPCRFNR017 | € 18,95 |
|                        |         |             |       | CR Red  | R-PSPCRFRS017 |         |
|                        |         |             |       | Black   | R-PSPCRFNR017 |         |
|                        |         |             |       | CR Red  | R-PSPCRFRS017 |         |
| CRFX                   | 450     | 2019 > 2023 |       | Black   | R-PSPCRFNR017 | € 18,95 |
|                        |         |             |       | CR Red  | R-PSPCRFRS017 |         |
|                        |         |             |       | Black   | R-PSPCRFNR017 |         |
|                        |         |             |       | CR Red  | R-PSPCRFRS017 |         |
| CRF-L                  | 450     | 2019 > 2021 |       | Black   | R-PSPCRFNR017 | € 18,95 |
|                        |         |             |       | CR Red  | R-PSPCRFRS017 |         |
|                        |         |             |       | Black   | R-PSPCRFNR017 |         |
|                        |         |             |       | CR Red  | R-PSPCRFRS017 |         |
| CRF-RWE                | 450     | 2019-2020   |       | Black   | R-PSPCRFNR017 | € 18,95 |
|                        |         |             |       | CR Red  | R-PSPCRFRS017 |         |
|                        |         |             |       | Black   | R-PSPCRFNR017 |         |
|                        |         |             |       | CR Red  | R-PSPCRFRS017 |         |
| CRF/ CRF-RX<br>CRF-RWE | 450     | 2021 > 2023 |       | Black   | R-PSPCRFNR021 | € 18,95 |
|                        |         |             |       | CR Red  | R-PSPCRFRS021 |         |
|                        |         |             |       | Black   | R-PSPCRFNR021 |         |
|                        |         |             |       | CR Red  | R-PSPCRFRS021 |         |



R-CRUCRRS0007



R-CRUCRNR0007

## AVAILABLE COLORS

■ CR Red ■ Black

**OEM** original color

| MOD                          | CC          | YEAR        | NOTES | COLOR  | CODE          | PRICE   |
|------------------------------|-------------|-------------|-------|--------|---------------|---------|
| CRF                          | 150         | 2007 > 2023 | OEM   | Black  | R-CRUCRFNR150 | € 25,95 |
| CR                           | 125-250     | 2005 > 2007 | OEM   | Black  | R-CRUCRNR0005 | € 25,95 |
|                              |             |             |       | CR Red | R-CRUCRRS0005 |         |
| CR                           | 125-250-500 | 1999 > 2004 | OEM   | Black  | R-CRUCRNR0003 | € 25,95 |
|                              |             |             |       | CR Red | R-CRUCRRS0003 |         |
| CRF / CRFX                   | 250         | 2004        | OEM   | Black  | R-CRUCRNR0003 | € 25,95 |
|                              |             |             |       | CR Red | R-CRUCRRS0003 |         |
| CRF / CRFX                   | 250-450     | 2005-2006   | OEM   | Black  | R-CRUCRNR0005 | € 25,95 |
|                              |             |             |       | CR Red | R-CRUCRRS0005 |         |
| CRF / CRFX<br>CRF-RX / CRF-L | 250-450     | 2007 > 2023 | OEM   | Black  | R-CRUCRNR0007 | € 25,95 |
|                              |             |             |       | CR Red | R-CRUCRRS0007 |         |
| CRF                          | 450         | 2002 > 2004 | OEM   | Black  | R-CRUCRNR0003 | € 25,95 |
|                              |             |             |       | CR Red | R-CRUCRRS0003 |         |



# HONDA CHAIN SLIDER / SLITTA SCORRICATENA FORCELLONE



R-SLICFRFS013



R-SLICFRNR019

## AVAILABLE COLORS

■ CR Red ■ Black

**OEM** original color

| MOD          | CC          | YEAR        | NOTES | COLOR  | CODE          | PRICE   |
|--------------|-------------|-------------|-------|--------|---------------|---------|
| CRF          | 150         | 2007 > 2023 | OEM   | Black  | R-SLICFRNR150 | € 25,95 |
|              |             |             |       | CR Red | R-SLICFRFS150 |         |
| CR           | 125-250-500 | 2000 > 2007 | OEM   | Black  | R-SLICRNR0003 | € 25,95 |
|              |             |             |       | CR Red | R-SLICRRS0003 |         |
| CRF          | 250         | 2004 > 2009 | OEM   | Black  | R-SLICRNR0003 | € 25,95 |
|              |             |             |       | CR Red | R-SLICRRS0003 |         |
| CRF          | 250         | 2010 > 2013 | OEM   | Black  | R-SLICFRNR009 | € 25,95 |
|              |             |             |       | CR Red | R-SLICFRFS009 |         |
| CRF          | 250         | 2014 > 2017 | OEM   | Black  | R-SLICFRNR013 | € 25,95 |
|              |             |             |       | CR Red | R-SLICFRFS013 |         |
| CRF          | 250         | 2018-2019   | OEM   | Black  | R-SLICFRNR017 | € 25,95 |
|              |             |             |       | CR Red | R-SLICFRFS017 |         |
| CRF / CRF-RX | 250         | 2020 > 2023 | OEM   | Black  | R-SLICFRNR019 | € 25,95 |
|              |             |             |       | CR Red | R-SLICFRFS019 |         |
| CRF          | 450         | 2002 > 2008 | OEM   | Black  | R-SLICRNR0003 | € 25,95 |
|              |             |             |       | CR Red | R-SLICRRS0003 |         |
| CRF          | 450         | 2009 > 2012 | OEM   | Black  | R-SLICFRNR009 | € 25,95 |
|              |             |             |       | CR Red | R-SLICFRFS009 |         |
| CRF          | 450         | 2013 > 2016 | OEM   | Black  | R-SLICFRNR013 | € 25,95 |
|              |             |             |       | CR Red | R-SLICFRFS013 |         |
| CRF / CRF-RX | 450         | 2017-2018   | OEM   | Black  | R-SLICFRNR017 | € 25,95 |
|              |             |             |       | CR Red | R-SLICFRFS017 |         |
| CRFX         | 250         | 2004 > 2017 | OEM   | Black  | R-SLICRNR0003 | € 25,95 |
|              |             |             |       | CR Red | R-SLICRRS0003 |         |
| CRFX         | 450         | 2005 > 2017 | OEM   | Black  | R-SLICRNR0003 | € 25,95 |
|              |             |             |       | CR Red | R-SLICRRS0003 |         |
| CRF-RX       | 250         | 2019        | OEM   | Black  | R-SLICFRNR017 | € 25,95 |
|              |             |             |       | CR Red | R-SLICFRFS017 |         |
| CRF/CRF-RX   | 450         | 2019 > 2023 | OEM   | Black  | R-SLICFRNR019 | € 25,95 |
|              |             |             | OEM   | CR Red | R-SLICFRFS019 |         |
| CRF-RWE      | 450         | 2019 > 2023 | OEM   | Black  | R-SLICFRNR019 | € 25,95 |
|              |             |             | OEM   | CR Red | R-SLICFRFS019 |         |

# HONDA REPLICA PLASTICS KIT / KIT PLASTICHE REPLICA



R-KITCRF-RS0-521

**OEM** original color - fluorescent color





















| MOD                              | CC      | YEAR        | NOTES   | COLOR       |  |  |  |  |  |  | CODE             | PRICE    |
|----------------------------------|---------|-------------|---|-------------|--|--|--|--|--|--|------------------|----------|
| CR                               | 85      | 2003 > 2007 |   | OEM         |  |  |  |  |  |  | R-KITCRF-OEM-511 | € 134,95 |
| CRF                              | 150     | 2007 > 2023 | OEM 2007 > 2021                                   | OEM         |  |  |  |  |  |  | R-KITCRF-OEM-510 | € 134,95 |
|                                  |         |             | OEM 2022-2023                                     | White       |  |  |  |  |  |  | R-KITCRF-BN0-510 |          |
|                                  |         |             |   | Black       |  |  |  |  |  |  | R-KITCRF-NR0-510 |          |
|                                  |         |             |   | CR Red      |  |  |  |  |  |  | R-KITCRF-RS0-510 |          |
| CR                               | 125-250 | 2000-2001   |   | OEM         |  |  |  |  |  |  | R-KITCR0-OEM-501 | € 134,95 |
| CR                               | 125-250 | 2002-2003   |   | OEM         |  |  |  |  |  |  | R-KITCR0-OEM-502 | € 134,95 |
|                                  |         |             |   | White       |  |  |  |  |  |  | R-KITCR0-BN0-502 |          |
| CR                               | 125-250 | 2004 > 2007 |   | OEM         |  |  |  |  |  |  | R-KITCR0-OEM-503 | € 134,95 |
|                                  |         |             |   | White       |  |  |  |  |  |  | R-KITCR0-BN0-503 |          |
|                                  |         |             |   | Black       |  |  |  |  |  |  | R-KITCR0-NR0-503 |          |
|                                  |         |             |   | CR Red      |  |  |  |  |  |  | R-KITCR0-RS0-503 |          |
| CRF                              | 250     | 2004-2005   |   | OEM         |  |  |  |  |  |  | R-KITCRF-OEM-507 | € 134,95 |
|                                  |         |             |   | White       |  |  |  |  |  |  | R-KITCRF-BN0-507 |          |
|                                  |         |             |   | Black       |  |  |  |  |  |  | R-KITCRF-NR0-507 |          |
|                                  |         |             |   | CR Red      |  |  |  |  |  |  | R-KITCRF-RS0-507 |          |
| CRF                              | 250     | 2006-2007   | OEM 2006-2007                                     | OEM         |  |  |  |  |  |  | R-KITCRF-OEM-508 | € 134,95 |
|                                  |         |             |   | White       |  |  |  |  |  |  | R-KITCRF-BN0-508 |          |
|                                  |         |             |   | Black       |  |  |  |  |  |  | R-KITCRF-NR0-508 |          |
|                                  |         |             |   | CR Red      |  |  |  |  |  |  | R-KITCRF-RS0-508 |          |
| CRF                              | 250     | 2008-2009   | OEM 2009  | OEM         |  |  |  |  |  |  | R-KITCRF-OEM-588 | € 134,95 |
|                                  |         |             |   | White       |  |  |  |  |  |  | R-KITCRF-BN0-588 |          |
|                                  |         |             |   | Black       |  |  |  |  |  |  | R-KITCRF-NR0-588 |          |
|                                  |         |             |   | CR Red      |  |  |  |  |  |  | R-KITCRF-RS0-588 |          |
| CRF                              | 250     | 2010        |   | OEM         |  |  |  |  |  |  | R-KITCRF-OEM-513 | € 134,95 |
| kit includes vented front fender |         |             |   | White       |  |  |  |  |  |  | R-KITCRF-BN0-513 |          |
|                                  |         |             |   | Black       |  |  |  |  |  |  | R-KITCRF-NR0-513 |          |
|                                  |         |             |   | CR Red      |  |  |  |  |  |  | R-KITCRF-RS0-513 |          |
| CRF                              | 250     | 2010 > 2013 | For USA market only                               | OEM         |  |  |  |  |  |  | R-KITCRF-OEM-513 | € 134,95 |
| kit includes vented front fender |         |             |   | White       |  |  |  |  |  |  | R-KITCRF-BN0-513 |          |
|                                  |         |             |   | Black       |  |  |  |  |  |  | R-KITCRF-NR0-513 |          |
|                                  |         |             |   | CR Red      |  |  |  |  |  |  | R-KITCRF-RS0-513 |          |
| CRF                              | 250     | 2011 > 2013 | Not for USA market                                | OEM         |  |  |  |  |  |  | R-KITCRF-OEM-516 | € 134,95 |
| kit includes vented front fender |         |             |   | White       |  |  |  |  |  |  | R-KITCRF-BN0-516 |          |
|                                  |         |             |   | Black       |  |  |  |  |  |  | R-KITCRF-NR0-516 |          |
|                                  |         |             |   | CR Red      |  |  |  |  |  |  | R-KITCRF-RS0-516 |          |
| CRF                              | 250     | 2014 > 2017 | OEM (with Air Box side cover) not for USA market  | OEM         |  |  |  |  |  |  | R-KITCRF-OEM-517 | € 159,95 |
| kit includes vented front fender |         |             |   | White       |  |  |  |  |  |  | R-KITCRF-BN0-517 |          |
|                                  |         |             |   | CR Red      |  |  |  |  |  |  | R-KITCRF-RS0-517 |          |
|                                  |         |             |   | Black       |  |  |  |  |  |  | R-KITCRF-NR0-517 |          |
|                                  |         |             |   | Neon Yellow |  |  |  |  |  |  | R-KITCRF-GF0-517 |          |
| CRF                              | 250     | 2014 > 2017 | OEM (with Air Box side cover) for USA market only | OEM         |  |  |  |  |  |  | R-KITCRF-OEM-518 | € 159,95 |
| kit includes vented front fender |         |             |   | White       |  |  |  |  |  |  | R-KITCRF-BN0-518 |          |
|                                  |         |             |   | CR Red      |  |  |  |  |  |  | R-KITCRF-RS0-518 |          |
|                                  |         |             |   | Black       |  |  |  |  |  |  | R-KITCRF-NR0-518 |          |
|                                  |         |             |   | Neon Yellow |  |  |  |  |  |  | R-KITCRF-GF0-518 |          |

# HONDA REPLICA PLASTICS KIT / KIT PLASTICHE REPLICA

**OEM** original color -  fluorescent color

| MOD  | CC  | YEAR        | NOTES  | COLOR          | CODE             | PRICE    |
|--|-----|-------------|--|----------------|------------------|----------|
| <b>CRF</b><br>kit includes vented front fender | 250 | 2018        |  | OEM            | R-KITCRF-OEM-599 | € 159,95 |
|  |     |             |  | White          | R-KITCRF-BN0-599 | € 159,95 |
|  |     |             |  | CR Red         | R-KITCRF-RS0-599 | € 159,95 |
|  |     |             |  | Black          | R-KITCRF-NR0-599 | € 159,95 |
|  |     |             |  | Neon Yellow    | R-KITCRF-GF0-599 | € 159,95 |
| With fork protectors and gas tank cover (Blue) | 250 | 2019 > 2021 | Limited Edition                                      | CR Red-YZ Blue | R-KITCRF-RSB-599 | € 177,95 |
|  |     |             |  | OEM            | R-KITCRF-OEM-519 | € 159,95 |
|  |     |             |  | White          | R-KITCRF-BN0-519 | € 159,95 |
|  |     |             |  | CR Red         | R-KITCRF-RS0-519 | € 159,95 |
|  |     |             |  | Black          | R-KITCRF-NR0-519 | € 159,95 |
| With fork protectors and gas tank cover (Blue) | 250 | 2022-2023   | Limited Edition<br>with fork protectors<br>OEM       | Neon Yellow    | R-KITCRF-GF0-519 | € 159,95 |
|  |     |             |  | Quantum Grey   | R-KITCRF-GR0-519 | € 159,95 |
|  |     |             |  | CR Red/Black   | R-KITCRF-RWE-519 | € 159,95 |
|  |     |             |  | CR Red-YZ Blue | R-KITCRF-RSB-519 | € 177,95 |
|  |     |             |  | OEM CR Red     | R-KITCRF-RS0-721 | € 172,95 |
| <b>CRF</b>                                     | 450 | 2002-2003   |  | CR Red         | R-KITCRF-RS0-521 | € 159,95 |
|  |     |             |  | White          | R-KITCRF-BN0-521 | € 159,95 |
|  |     |             |  | Black          | R-KITCRF-NR0-521 | € 159,95 |
|  |     |             |  | Quantum Grey   | R-KITCRF-GR0-521 | € 159,95 |
|  |     |             |  | OEM            | R-KITCRF-OEM-504 | € 134,95 |
| <b>CRF</b>                                     | 450 | 2004        |  | OEM            | R-KITCRF-OEM-505 | € 134,95 |
|  |     |             |  | Black          | R-KITCRF-NR0-505 | € 134,95 |
| <b>CRF</b>                                     | 450 | 2005-2006   |  | OEM            | R-KITCRF-OEM-506 | € 134,95 |
|  |     |             |  | White          | R-KITCRF-BN0-506 | € 134,95 |
|  |     |             |  | Black          | R-KITCRF-NR0-506 | € 134,95 |
|  |     |             |  | CR Red         | R-KITCRF-RS0-506 | € 134,95 |
|  |     |             |  | OEM            | R-KITCRF-OEM-509 | € 134,95 |
| <b>CRF</b>                                     | 450 | 2007        |  | White          | R-KITCRF-BN0-509 | € 134,95 |
|  |     |             |  | Black          | R-KITCRF-NR0-509 | € 134,95 |
|  |     |             |  | CR Red         | R-KITCRF-RS0-509 | € 134,95 |
|  |     |             |  | OEM            | R-KITCRF-OEM-589 | € 134,95 |
|  |     |             |  | White          | R-KITCRF-BN0-589 | € 134,95 |
| <b>CRF</b><br>kit includes vented front fender | 450 | 2009-2010   |  | CR Red         | R-KITCRF-RS0-589 | € 134,95 |
|  |     |             |  | OEM            | R-KITCRF-OEM-513 | € 134,95 |
|  |     |             |  | White          | R-KITCRF-BN0-513 | € 134,95 |
|  |     |             |  | Black          | R-KITCRF-NR0-513 | € 134,95 |
|  |     |             |  | CR Red         | R-KITCRF-RS0-513 | € 134,95 |
| <b>CRF</b><br>kit includes vented front fender | 450 | 2011-2012   | Not for USA market                                   | OEM            | R-KITCRF-OEM-516 | € 134,95 |
|  |     |             |  | White          | R-KITCRF-BN0-516 | € 134,95 |
|  |     |             |  | Black          | R-KITCRF-NR0-516 | € 134,95 |
|  |     |             |  | CR Red         | R-KITCRF-RS0-516 | € 134,95 |
|  |     |             |  | OEM            | R-KITCRF-OEM-513 | € 134,95 |
| <b>CRF</b><br>kit includes vented front fender | 450 | 2009 > 2012 | For USA market only                                  | White          | R-KITCRF-BN0-513 | € 134,95 |
|  |     |             |  | Black          | R-KITCRF-NR0-513 | € 134,95 |
|  |     |             |  | CR Red         | R-KITCRF-RS0-513 | € 134,95 |
|  |     |             |  | OEM            | R-KITCRF-OEM-517 | € 159,95 |
|  |     |             |  | White          | R-KITCRF-BN0-517 | € 159,95 |
| <b>CRF</b><br>kit includes vented front fender | 450 | 2013 > 2016 | OEM (with Air Box side cover)<br>not for USA market  | CR Red         | R-KITCRF-RS0-517 | € 159,95 |
|  |     |             |  | Black          | R-KITCRF-NR0-517 | € 159,95 |
|  |     |             |  | Neon Yellow    | R-KITCRF-GF0-517 | € 159,95 |
|  |     |             |  | OEM            | R-KITCRF-OEM-518 | € 159,95 |
|  |     |             |  | White          | R-KITCRF-BN0-518 | € 159,95 |
| <b>CRF</b><br>kit includes vented front fender | 450 | 2013 > 2016 | OEM (with Air Box side cover)<br>for USA market only | CR Red         | R-KITCRF-RS0-518 | € 159,95 |
|  |     |             |  | Black          | R-KITCRF-NR0-518 | € 159,95 |
|  |     |             |  | Neon Yellow    | R-KITCRF-GF0-518 | € 159,95 |
|  |     |             |  | OEM            | R-KITCRF-OEM-599 | € 159,95 |
|  |     |             |  | White          | R-KITCRF-BN0-599 | € 159,95 |
| <b>CRF</b><br>kit includes vented front fender | 450 | 2017-2018   |  | CR Red         | R-KITCRF-RS0-599 | € 159,95 |
|  |     |             |  | Black          | R-KITCRF-NR0-599 | € 159,95 |
|  |     |             |  | Neon Yellow    | R-KITCRF-GF0-599 | € 159,95 |
|  |     |             |  | OEM            | R-KITCRF-OEM-519 | € 159,95 |
|  |     |             |  | White          | R-KITCRF-BN0-519 | € 159,95 |
| With fork protectors and gas tank cover (Blue) | 450 | 2019-2020   | Limited Edition                                      | CR Red-YZ Blue | R-KITCRF-RSB-599 | € 177,95 |
|  |     |             |  | OEM            | R-KITCRF-OEM-519 | € 159,95 |
|  |     |             |  | White          | R-KITCRF-BN0-519 | € 159,95 |
|  |     |             |  | CR Red         | R-KITCRF-RS0-519 | € 159,95 |
|  |     |             |  | Black          | R-KITCRF-NR0-519 | € 159,95 |
| With fork protectors and gas tank cover (Blue) | 450 | 2021 > 2023 | Limited Edition<br>with fork protectors<br>OEM       | Neon Yellow    | R-KITCRF-GF0-519 | € 159,95 |
|  |     |             |  | Quantum Grey   | R-KITCRF-GR0-519 | € 159,95 |
|  |     |             |  | CR Red/Black   | R-KITCRF-RWE-519 | € 159,95 |
|  |     |             |  | CR Red-YZ Blue | R-KITCRF-RSB-519 | € 177,95 |
|  |     |             |  | OEM CR Red     | R-KITCRF-RS0-721 | € 172,95 |
| <b>CRF/CRF-RWE</b>                             | 450 | 2019-2020   |  | CR Red         | R-KITCRF-RS0-521 | € 159,95 |
|  |     |             |  | White          | R-KITCRF-BN0-521 | € 159,95 |
|  |     |             |  | Black          | R-KITCRF-NR0-521 | € 159,95 |
|  |     |             |  | Quantum Grey   | R-KITCRF-GR0-521 | € 159,95 |
|  |     |             |  | OEM            | R-KITCRF-OEM-519 | € 159,95 |

OEM original color -  fluorescent color

| MOD  | CC  | YEAR             | NOTES           | COLOR  |   | CODE             | PRICE    |
|--|---|------------------|-----------------|--------|---|------------------|----------|
| CRFX                                       | 250   | 2004 > 2019      | OEM 2009 > 2019 | OEM    |    | R-KITCRX-OEM-412 | € 124,95 |
|  |   |                  |                 | White  |   | R-KITCRX-BN0-412 |          |
|  |   |                  |                 | Black  |  | R-KITCRX-NR0-412 |          |
| CRFX                                       | 450   | 2005 > 2007      |                 | CR Red |  | R-KITCRX-RS0-412 |          |
|  |   |                  |                 | OEM    |  | R-KITCRX-OEM-414 | € 124,95 |
|  |   |                  |                 | Black  |  | R-KITCRX-NR0-414 |          |
| CR Red                                     |  | R-KITCRX-RS0-414 |                 |        |   |                  |          |
| CRFX                                       | 450   | 2008 > 2017      | OEM 2009 > 2017 | OEM    |    | R-KITCRX-OEM-415 | € 124,95 |
|  |   |                  |                 | White  |   | R-KITCRX-BN0-415 |          |
|  |   |                  |                 | Black  |  | R-KITCRX-NR0-415 |          |
| CRF-RX<br>kit includes vented front fender | 250   | 2019 > 2021      |                 | OEM    |    | R-KITCRF-OEM-601 | € 164,95 |
|  |   |                  |                 | White  |   | R-KITCRF-BN0-601 |          |
|  |   |                  |                 | CR Red |  | R-KITCRF-RS0-601 |          |
| CRF-RX<br>kit includes vented front fender | 450   | 2017-2018        |                 | Black  |  | R-KITCRF-NR0-601 |          |
|  |   |                  |                 | OEM    |  | R-KITCRF-OEM-600 | € 164,95 |
|  |   |                  |                 | White  |  | R-KITCRF-BN0-600 |          |
| CR Red                                     |  | R-KITCRF-RS0-600 |                 |        |   |                  |          |
| CRF-RX<br>kit includes vented front fender | 450   | 2019-2020        |                 | Black  |    | R-KITCRF-NR0-600 |          |
|  |   |                  |                 | OEM    |   | R-KITCRF-OEM-601 | € 164,95 |
|  |   |                  |                 | White  |  | R-KITCRF-BN0-601 |          |
| CR Red                                     |  | R-KITCRF-RS0-601 |                 |        |   |                  |          |
|  |   |                  |                 | Black  |  | R-KITCRF-NR0-601 |          |



R-KITCRF-RS0-600



## **YAMAHA**

**Front fender** / Parafango anteriore >**pag 102**

**Vented front fender** / Parafango anteriore ventilato >**pag 103**

**Rear fender** / Parafango posteriore >**pag 105**

**Radiator shrouds** / Convogliatori aria radiatore >**pag 107**

**Gas tank cover** / Copriserbatoio >**pag 110**

**Oversize radiator louvers** / Griglie radiatore maggiorate >**pag 111**

**Side panels** / Tabelle laterali portanumero >**pag 112**

**Airbox side panels** / Coperchi laterali cassa filtro >**pag 113**

**Front number plate** / Tabella portanumero anteriore >**pag 114**

**Fork protectors** / Parasteli forcella >**pag 116**

**Rear shock mud flap** / Paraspruzzi monoammortizzatore >**pag 117**

**Chain guide** / Cruna guida catena >**pag 118**

**Chain slider** / Slitta scorricatena forcellone >**pag 118**

**Replica plastics kit** / Kit plastiche replica >**pag 119**

# YAMAHA FRONT FENDER / PARAFANGO ANTERIORE

## AVAILABLE COLORS

YZ Blue
  Black
  White
  Quantum Grey

**OEM** original color

| MODEL                                      | CC              | YEAR        | NOTES                               | COLOR        | CODE          | PRICE   |
|--|-----------------|-------------|-------------------------------------|--------------|---------------|---------|
| YZ   | 65              | 2018 > 2023 | OEM                                 | YZ Blue      | R-PAYZ0BL0065 | € 25,95 |
|  |                 |             |                                     | Black        | R-PAYZ0NR0065 |         |
| YZ   | 80              | 1993 > 2001 | OEM                                 | YZ Blue      | R-PAYZ0BL0085 | € 25,95 |
| YZ   | 85              | 2002 > 2014 | OEM                                 | YZ Blue      | R-PAYZ0BL0085 | € 25,95 |
| YZ   | 85              | 2015 > 2021 | OEM                                 | YZ Blue      | R-PAYZ0BL1585 | € 39,95 |
| YZ   | 85              | 2022-2023   | OEM                                 | YZ Blue      | R-PAYZ0BL2285 | € 39,95 |
|  |                 |             |                                     | White        | R-PAYZ0BN2285 |         |
|  |                 |             |                                     | Black        | R-PAYZ0NR2285 |         |
|  |                 |             |                                     | Quantum Grey | R-PAYZ0GR2285 |         |
| YZ / WR<br>adaptable to all 96/99 models   | 125-250         | 2000 > 2005 | OEM                                 | YZ Blue      | R-PAYZ0BL9603 | € 29,95 |
|  |                 |             |                                     | White        | R-PAYZ0BN9603 |         |
|  |                 |             |                                     | Black        | R-PAYZ0NR9603 |         |
| YZ / WR /<br>WRF                           | 125-250         | 2006 > 2014 | OEM                                 | YZ Blue      | R-PAYZ0BL0006 | € 29,95 |
|  |                 |             |                                     | White        | R-PAYZ0BN0006 |         |
|  |                 |             |                                     | Black        | R-PAYZ0NR0006 |         |
| YZ   | 125-250         | 2015 > 2021 | OEM                                 | YZ Blue      | R-PAYZFBL0010 | € 29,95 |
|  |                 |             |                                     | White        | R-PAYZFBN0010 |         |
|  |                 |             |                                     | Black        | R-PAYZFNR0010 |         |
| YZ   | 125-250         | 2022-2023   | OEM                                 | YZ Blue      | R-PAYZFBL0018 | € 29,95 |
|  |                 |             |                                     | White        | R-PAYZFBN0018 |         |
|  |                 |             |                                     | Black        | R-PAYZFNR0018 |         |
| YZ-X                                       | 125             | 2020 > 2022 | OEM                                 | YZ Blue      | R-PAYZFBL0010 | € 29,95 |
|  |                 |             |                                     | White        | R-PAYZFBN0010 |         |
|  |                 |             |                                     | Black        | R-PAYZFNR0010 |         |
| YZ-X                                       | 125-250         | 2023        | OEM                                 | YZ Blue      | R-PAYZFBL0018 | € 29,95 |
|  |                 |             |                                     | White        | R-PAYZFBN0018 |         |
|  |                 |             |                                     | Black        | R-PAYZFNR0018 |         |
| YZ-FX                                      | 250             | 2015 > 2019 | OEM                                 | YZ Blue      | R-PAYZFBL0010 | € 29,95 |
|  |                 |             |                                     | White        | R-PAYZFBN0010 |         |
|  |                 |             |                                     | Black        | R-PAYZFNR0010 |         |
| YZ-FX                                      | 250             | 2020 > 2023 | OEM                                 | YZ Blue      | R-PAYZFBL0018 | € 29,95 |
|  |                 |             |                                     | White        | R-PAYZFBN0018 |         |
|  |                 |             |                                     | Black        | R-PAYZFNR0018 |         |
| YZ-FX                                      | 450             | 2015 > 2018 | OEM                                 | YZ Blue      | R-PAYZFBL0010 | € 29,95 |
|  |                 |             |                                     | White        | R-PAYZFBN0010 |         |
|  |                 |             |                                     | Black        | R-PAYZFNR0010 |         |
| YZF / WRF<br>adaptable to all 96/99 models | 250-400-426-450 | 2000 > 2005 | OEM                                 | YZ Blue      | R-PAYZ0BL9603 | € 29,95 |
|  |                 |             |                                     | White        | R-PAYZ0BN9603 |         |
|  |                 |             |                                     | Black        | R-PAYZ0NR9603 |         |
| YZF  | 250-450         | 2006 > 2009 | OEM                                 | YZ Blue      | R-PAYZ0BL0006 | € 29,95 |
|  |                 |             |                                     | White        | R-PAYZ0BN0006 |         |
|  |                 |             |                                     | Black        | R-PAYZ0NR0006 |         |
| YZF  | 250             | 2010 > 2018 | OEM                                 | YZ Blue      | R-PAYZFBL0010 | € 29,95 |
|  |                 |             |                                     | White        | R-PAYZFBN0010 |         |
|  |                 |             |                                     | Black        | R-PAYZFNR0010 |         |
| YZF  | 250             | 2019 > 2022 | OEM                                 | YZ Blue      | R-PAYZFBL0018 | € 29,95 |
|  |                 |             | OEM                                 | White        | R-PAYZFBN0018 |         |
|  |                 |             | OEM -Monster Energy Edition 2021-22 | Black        | R-PAYZFNR0018 |         |
| YZF  | 450             | 2010 > 2017 | OEM                                 | YZ Blue      | R-PAYZFBL0010 | € 29,95 |
|  |                 |             |                                     | White        | R-PAYZFBN0010 |         |
|  |                 |             |                                     | Black        | R-PAYZFNR0010 |         |
| YZF  | 450             | 2018 > 2022 | OEM                                 | YZ Blue      | R-PAYZFBL0018 | € 29,95 |
|  |                 |             | OEM                                 | White        | R-PAYZFBN0018 |         |
|  |                 |             |                                     | Black        | R-PAYZFNR0018 |         |
| YZF  | 450             | 2023        | OEM                                 | YZ Blue      | R-PAYZFBL0023 | € 29,95 |
|  |                 |             | OEM -Monster Energy Edition 2022    | White        | R-PAYZFBN0023 |         |
|  |                 |             |                                     | Black        | R-PAYZFNR0023 |         |
|  |                 |             |                                     | Quantum Grey | R-PAYZFG0023  |         |
| YZ-FX                                      | 450             | 2019 > 2022 | OEM                                 | YZ Blue      | R-PAYZFBL0018 | € 29,95 |
|  |                 |             |                                     | White        | R-PAYZFBN0018 |         |
|  |                 |             |                                     | Black        | R-PAYZFNR0018 |         |
| WRF  | 250             | 2015 > 2019 | OEM                                 | YZ Blue      | R-PAYZFBL0010 | € 29,95 |
|  |                 |             |                                     | White        | R-PAYZFBN0010 |         |
|  |                 |             |                                     | Black        | R-PAYZFNR0010 |         |
| WRF  | 250             | 2020 > 2023 | OEM                                 | YZ Blue      | R-PAYZFBL0018 | € 29,95 |
|  |                 |             |                                     | White        | R-PAYZFBN0018 |         |
|  |                 |             |                                     | Black        | R-PAYZFNR0018 |         |
| WRF  | 450             | 2006 > 2011 | OEM                                 | YZ Blue      | R-PAYZ0BL0006 | € 29,95 |
|  |                 |             |                                     | White        | R-PAYZ0BN0006 |         |
|  |                 |             |                                     | Black        | R-PAYZ0NR0006 |         |
| WRF  | 450             | 2012 > 2018 | OEM                                 | YZ Blue      | R-PAYZFBL0010 | € 29,95 |
|  |                 |             |                                     | White        | R-PAYZFBN0010 |         |
|  |                 |             |                                     | Black        | R-PAYZFNR0010 |         |
| WRF  | 450             | 2019 > 2023 | OEM                                 | YZ Blue      | R-PAYZFBL0018 | € 29,95 |
|  |                 |             |                                     | White        | R-PAYZFBN0018 |         |
|  |                 |             |                                     | Black        | R-PAYZFNR0018 |         |
| WR / YZ-X                                  | 250             | 2016 > 2022 | OEM                                 | YZ Blue      | R-PAYZFBL0010 | € 29,95 |
|  |                 |             |                                     | White        | R-PAYZFBN0010 |         |
|  |                 |             |                                     | Black        | R-PAYZFNR0010 |         |

# YAMAHA VENTED FRONT FENDER / PARAFANGO ANTERIORE VENTILATO

ALL FENDERS ON THIS PAGE ARE VENTED AIRFLOW MODELS / PARAFANGO CON PRE-TAGLIO PER LA VENTILAZIONE

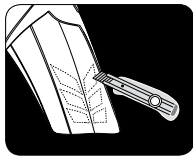

R-PAYZFBN0018



R-PAYZFN0018



R-PAYZFB0018

## AVAILABLE COLORS

|  |              |  |          |  |             |  |                 |
|--|--------------|--|----------|--|-------------|--|-----------------|
|  | YZ Blue      |  | Black    |  | White       |  | CR Red          |
|  | Quantum Grey |  | Y Yellow |  | Neon Yellow |  | Ducati Neon Red |

**OEM** original color - fluorescent color

| MODEL         | CC      | YEAR          | NOTES  | COLOR           |         | CODE          | PRICE   |
|---------------|---------|---------------|--|-----------------|---------|---------------|---------|
| YZ Revolution | 125-250 | 2002 > 2021   | OEM-Vented front fender - to drill<br>Vented front fender - to drill<br>Vented front fender - to drill<br>Vented front fender - to drill<br>Vented front fender - to drill<br>Vented front fender - to drill - Limited Edition<br>Vented front fender - to drill - Limited Edition | YZ Blue         |         | R-PAYZFB09911 | € 29,95 |
|               |         |               |  | White           |         | R-PAYZFBN9911 |         |
|               |         |               |  | Black           |         | R-PAYZFN09911 |         |
|               |         |               |  | Y Yellow        |         | R-PAYZFGY9911 |         |
|               |         |               |  | Neon Yellow     |         | R-PAYZFGF9911 |         |
|               |         |               |  | Quantum Grey    |         | R-PAYZFG9911  |         |
|               |         |               |  | Ducati Neon Red |         | R-PAYZFRD9911 |         |
|               |         |               |  | YZ              | 125-250 | 2015 > 2021   |         |
| White         |         | R-PAYZFBN9910 |  |                 |         |               |         |
| Black         |         | R-PAYZFN09910 |  |                 |         |               |         |
| Y Yellow      |         | R-PAYZFGY9910 |  |                 |         |               |         |
| Neon Yellow   |         | R-PAYZFGF9910 |  |                 |         |               |         |
| CR Red        |         | R-PAYZFRS9910 |  |                 |         |               |         |
| YZ            | 125-250 | 2022-2023     | OEM - Vented front fender<br>Vented front fender<br>Vented front fender<br>Vented front fender<br>Vented front fender<br>Vented front fender - Limited Edition   | YZ Blue         |         | R-PAYZFB09918 | € 29,95 |
|               |         |               |  | White           |         | R-PAYZFBN9918 |         |
|               |         |               |  | Black           |         | R-PAYZFN09918 |         |
|               |         |               |  | Y Yellow        |         | R-PAYZFGY9918 |         |
|               |         |               |  | Neon Yellow     |         | R-PAYZFGF9918 |         |
|               |         |               |  | Quantum Grey    |         | R-PAYZFG9918  |         |
| YZ -X         | 125     | 2020 > 2022   | OEM - Vented front fender<br>Vented front fender<br>Vented front fender<br>Vented front fender<br>Vented front fender<br>Vented front fender   | YZ Blue         |         | R-PAYZFB09910 | € 29,95 |
|               |         |               |  | White           |         | R-PAYZFBN9910 |         |
|               |         |               |  | Black           |         | R-PAYZFN09910 |         |
|               |         |               |  | Y Yellow        |         | R-PAYZFGY9910 |         |
|               |         |               |  | Neon Yellow     |         | R-PAYZFGF9910 |         |
|               |         |               |  | CR Red          |         | R-PAYZFRS9910 |         |
| YZ -X         | 250     | 2016 > 2022   | OEM - Vented front fender<br>Vented front fender<br>Vented front fender<br>Vented front fender<br>Vented front fender<br>Vented front fender   | YZ Blue         |         | R-PAYZFB09910 | € 29,95 |
|               |         |               |  | White           |         | R-PAYZFBN9910 |         |
|               |         |               |  | Black           |         | R-PAYZFN09910 |         |
|               |         |               |  | Y Yellow        |         | R-PAYZFGY9910 |         |
|               |         |               |  | Neon Yellow     |         | R-PAYZFGF9910 |         |
|               |         |               |  | CR Red          |         | R-PAYZFRS9910 |         |
| YZ -X         | 125-250 | 2023          | OEM - Vented front fender<br>Vented front fender<br>Vented front fender<br>Vented front fender<br>Vented front fender<br>Vented front fender - Limited Edition   | YZ Blue         |         | R-PAYZFB09918 | € 29,95 |
|               |         |               |  | White           |         | R-PAYZFBN9918 |         |
|               |         |               |  | Black           |         | R-PAYZFN09918 |         |
|               |         |               |  | Y Yellow        |         | R-PAYZFGY9918 |         |
|               |         |               |  | Neon Yellow     |         | R-PAYZFGF9918 |         |
|               |         |               |  | Quantum Grey    |         | R-PAYZFG9918  |         |
| YZ-FX / WRF   | 250     | 2015 > 2019   | OEM - Vented front fender<br>Vented front fender<br>Vented front fender<br>Vented front fender<br>Vented front fender<br>Vented front fender   | YZ Blue         |         | R-PAYZFB09910 | € 29,95 |
|               |         |               |  | White           |         | R-PAYZFBN9910 |         |
|               |         |               |  | Black           |         | R-PAYZFN09910 |         |
|               |         |               |  | Y Yellow        |         | R-PAYZFGY9910 |         |
|               |         |               |  | Neon Yellow     |         | R-PAYZFGF9910 |         |
|               |         |               |  | CR Red          |         | R-PAYZFRS9910 |         |
| YZ-FX / WRF   | 250     | 2020 > 2023   | OEM - Vented front fender<br>Vented front fender<br>Vented front fender<br>Vented front fender<br>Vented front fender<br>Vented front fender - Limited Edition   | YZ Blue         |         | R-PAYZFB09918 | € 29,95 |
|               |         |               |  | White           |         | R-PAYZFBN9918 |         |
|               |         |               |  | Black           |         | R-PAYZFN09918 |         |
|               |         |               |  | Y Yellow        |         | R-PAYZFGY9918 |         |
|               |         |               |  | Neon Yellow     |         | R-PAYZFGF9918 |         |
|               |         |               |  | Quantum Grey    |         | R-PAYZFG9918  |         |

**NEW**

# YAMAHA VENTED FRONT FENDER / PARAFANGO ANTERIORE VENTILATO

ALL FENDERS ON THIS PAGE ARE VENTED AIRFLOW MODELS / PARAFANGO CON PRE-TAGLIO PER LA VENTILAZIONE

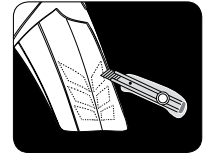

R-PAYZFGY9910



R-PAYZFB9910

**OEM** original color - fluorescent color

| MODEL      | CC  | YEAR        | NOTES                                 | COLOR        |  | CODE          |         |
|------------|-----|-------------|---------------------------------------|--------------|--|---------------|---------|
| YZ-FX      | 450 | 2015 > 2018 | OEM - Vented front fender             | YZ Blue      |  | R-PAYZFB9910  | € 29,95 |
|            |     |             | Vented front fender                   | White        |  | R-PAYZFB9910  |         |
|            |     |             | Vented front fender                   | Black        |  | R-PAYZFNR9910 |         |
|            |     |             | Vented front fender                   | Y Yellow     |  | R-PAYZFGY9910 |         |
|            |     |             | Vented front fender                   | Neon Yellow  |  | R-PAYZFGF9910 |         |
|            |     |             | Vented front fender                   | CR Red       |  | R-PAYZFRS9910 |         |
| YZF        | 250 | 2010 > 2018 | OEM - Vented front fender             | YZ Blue      |  | R-PAYZFB9910  | € 29,95 |
|            |     |             | Vented front fender                   | White        |  | R-PAYZFB9910  |         |
|            |     |             | Vented front fender                   | Black        |  | R-PAYZFNR9910 |         |
|            |     |             | Vented front fender                   | Y Yellow     |  | R-PAYZFGY9910 |         |
|            |     |             | Vented front fender                   | Neon Yellow  |  | R-PAYZFGF9910 |         |
|            |     |             | Vented front fender                   | CR Red       |  | R-PAYZFRS9910 |         |
| YZF        | 250 | 2019 > 2022 | OEM - Vented front fender             | YZ Blue      |  | R-PAYZFB9918  | € 29,95 |
|            |     |             | OEM - Vented front fender             | White        |  | R-PAYZFB9918  |         |
|            |     |             | Vented front fender                   | Black        |  | R-PAYZFNR9918 |         |
|            |     |             | Vented front fender                   | Y Yellow     |  | R-PAYZFGY9918 |         |
|            |     |             | Vented front fender                   | Neon Yellow  |  | R-PAYZFGF9918 |         |
|            |     |             | Vented front fender - Limited Edition | Quantum Grey |  | R-PAYZFR9918  |         |
| YZF        | 450 | 2010 > 2017 | OEM - Vented front fender             | YZ Blue      |  | R-PAYZFB9910  | € 29,95 |
|            |     |             | Vented front fender                   | White        |  | R-PAYZFB9910  |         |
|            |     |             | Vented front fender                   | Black        |  | R-PAYZFNR9910 |         |
|            |     |             | Vented front fender                   | Y Yellow     |  | R-PAYZFGY9910 |         |
|            |     |             | Vented front fender                   | Neon Yellow  |  | R-PAYZFGF9910 |         |
|            |     |             | Vented front fender                   | CR Red       |  | R-PAYZFRS9910 |         |
| YZF        | 450 | 2018 > 2022 | OEM - Vented front fender             | YZ Blue      |  | R-PAYZFB9918  | € 29,95 |
|            |     |             | Vented front fender                   | White        |  | R-PAYZFB9918  |         |
|            |     |             | Vented front fender                   | Black        |  | R-PAYZFNR9918 |         |
|            |     |             | Vented front fender                   | Y Yellow     |  | R-PAYZFGY9918 |         |
|            |     |             | Vented front fender                   | Neon Yellow  |  | R-PAYZFGF9918 |         |
|            |     |             | Vented front fender - Limited Edition | Quantum Grey |  | R-PAYZFR9918  |         |
| WRF        | 450 | 2012 > 2018 | OEM - Vented front fender             | YZ Blue      |  | R-PAYZFB9910  | € 29,95 |
|            |     |             | Vented front fender                   | White        |  | R-PAYZFB9910  |         |
|            |     |             | Vented front fender                   | Black        |  | R-PAYZFNR9910 |         |
|            |     |             | Vented front fender                   | Y Yellow     |  | R-PAYZFGY9910 |         |
|            |     |             | Vented front fender                   | Neon Yellow  |  | R-PAYZFGF9910 |         |
|            |     |             | Vented front fender                   | CR Red       |  | R-PAYZFRS9910 |         |
| YZ-FX/ WRF | 450 | 2019 > 2023 | OEM - Vented front fender             | YZ Blue      |  | R-PAYZFB9918  | € 29,95 |
|            |     |             | Vented front fender                   | White        |  | R-PAYZFB9918  |         |
|            |     |             | Vented front fender                   | Black        |  | R-PAYZFNR9918 |         |
|            |     |             | Vented front fender                   | Y Yellow     |  | R-PAYZFGY9918 |         |
|            |     |             | Vented front fender                   | Neon Yellow  |  | R-PAYZFGF9918 |         |
|            |     |             | Vented front fender - Limited Edition | Quantum Grey |  | R-PAYZFR9918  |         |

# YAMAHA REAR FENDER / PARAFANGO POSTERIORE



R-PPYZFBL0018



R-PPYZFBN0018



R-PPYZFGF0018



R-PPYZFNR0018



R-PPYZFGY0018





































R-PPYZFGR0018

## AVAILABLE COLORS

|  |  |   |   |
|--|--|---|---|
|  YZ Blue      |  Black    |  White       |  CR Red          |
|  Quantum Grey |  Y Yellow |  Neon Yellow |  Ducati Neon Red |

**OEM** original color -  fluorescent color

| MODEL                | CC      | YEAR        | NOTES   | COLOR           | CODE  | PRICE   |
|----------------------|---------|-------------|---|-----------------|---|---------|
| YZ                   | 65      | 2018 > 2023 | OEM   | YZ Blue         |  R-PPYZOBL0065   | € 27,95 |
|                      |         |             |   | Black           |  R-PPYZONR0065   |         |
| YZ                   | 85      | 2002 > 2021 | OEM 2002 > 2012 and 2015 > 2020<br>OEM 2013 > 2014      | YZ Blue         |  R-PPYZOBL0085   | € 27,95 |
|                      |         |             |   | White           |  R-PPYZOBN0085   |         |
| YZ                   | 85      | 2022-2023   | OEM   | YZ Blue         |  R-PPYZOBL2285   | € 27,95 |
|                      |         |             |   | White           |  R-PPYZOBN2285   |         |
|                      |         |             |   | Black           |  R-PPYZONR2285 |         |
|                      |         |             |   | Quantum Grey    |  R-PPYZOGR2285 |         |
|                      |         |             |   | YZ Blue         |  R-PPYZOBL9601 |         |
| YZ / WR              | 125-250 | 1996 > 2001 | OEM   | White           |  R-PPYZOBN9601 | € 31,95 |
|                      |         |             |   | Black           |  R-PPYZONR9601 |         |
|                      |         |             |   | White           |  R-PPYZOBN0203 |         |
| YZ / WR<br>NEW STYLE | 125-250 | 2002 > 2014 | OEM 2013-2014<br>OEM 2002 > 2012                        | YZ Blue         |  R-PPYZOBL0203 | € 31,95 |
|                      |         |             |   | Black           |  R-PPYZONR0203 |         |
| YZ                   | 125-250 | 2015 > 2021 | OEM   | YZ Blue         |  R-PPYZOBL0015 | € 31,95 |
|                      |         |             |   | White           |  R-PPYZOBN0015 |         |
|                      |         |             |   | Black           |  R-PPYZONR0015 |         |
|                      |         |             |   | Neon Yellow     |  R-PPYZOZF0015 |         |
|                      |         |             |   | Y Yellow        |  R-PPYZOZY0015 |         |
|                      |         |             |   | Quantum Grey    |  R-PPYZOGR0015 |         |
|                      |         |             |   | Ducati Neon Red |  R-PPYZORD0015 |         |
| YZ                   | 125-250 | 2022-2023   | OEM   | YZ Blue         |  R-PPYZOBL0022 | € 31,95 |
|                      |         |             |   | White           |  R-PPYZOBN0022 |         |
|                      |         |             |   | Black           |  R-PPYZONR0022 |         |
|                      |         |             |   | Quantum Grey    |  R-PPYZOGR0022 |         |
|                      |         |             |   | YZ Blue         |  R-PPYZOBL0015 |         |
| YZ-X                 | 125     | 2020 > 2022 | OEM   | White           |  R-PPYZOBN0015 | € 31,95 |
|                      |         |             |   | Black           |  R-PPYZONR0015 |         |
|                      |         |             |   | Neon Yellow     |  R-PPYZOZF0015 |         |
|                      |         |             |   | Y Yellow        |  R-PPYZOZY0015 |         |
|                      |         |             |   | Quantum Grey    |  R-PPYZOGR0015 |         |
|                      |         |             |   | Ducati Neon Red |  R-PPYZORD0015 |         |
|                      |         |             |   | YZ Blue         |  R-PPYZOBL0015 |         |
| YZ-X                 | 250     | 2016 > 2022 | OEM   | White           |  R-PPYZOBN0015 | € 31,95 |
|                      |         |             |   | Black           |  R-PPYZONR0015 |         |
|                      |         |             |   | Neon Yellow     |  R-PPYZOZF0015 |         |
|                      |         |             |   | Y Yellow        |  R-PPYZOZY0015 |         |
|                      |         |             |   | Quantum Grey    |  R-PPYZOGR0015 |         |
| YZ-X                 | 125-250 | 2023        | OEM   | Ducati Neon Red |  R-PPYZORD0015 | € 31,95 |
|                      |         |             |   | YZ Blue         |  R-PPYZOBL0022 |         |
|                      |         |             |   | White           |  R-PPYZOBN0022 |         |
|                      |         |             |   | Black           |  R-PPYZONR0022 |         |
|                      |         |             |   | Quantum Grey    |  R-PPYZOGR0022 |         |
| YZF                  | 250     | 2001-2002   | OEM   | YZ Blue         |  R-PPYZOBL9601 | € 31,95 |
|                      |         |             |   | White           |  R-PPYZOBN9601 |         |
|                      |         |             |   | Black           |  R-PPYZONR9601 |         |
| YZF                  | 250     | 2010 > 2013 | OEM 2010 and 2013<br>OEM 2010 > 2012<br>OEM 2011 > 2013 | White           |  R-PPYZFBN0025 | € 31,95 |
|                      |         |             |   | YZ Blue         |  R-PPYZFBL0025 |         |
|                      |         |             |   | Black           |  R-PPYZFNR0025 |         |
| YZF<br>NEW STYLE     | 250-450 | 2003 > 2005 | OEM   | YZ Blue         |  R-PPYZFBL0300 | € 31,95 |
|                      |         |             |   | White           |  R-PPYZFBN0300 |         |
|                      |         |             |   | Black           |  R-PPYZFNR0300 |         |
|                      |         |             |   | Y Yellow        |  R-PPYZFGY0300 |         |
| YZF                  | 250-450 | 2006 > 2009 | OEM   | White           |  R-PPYZFBN0006 | € 31,95 |
|                      |         |             |   | YZ Blue         |  R-PPYZFBL0006 |         |
|                      |         |             |   | Black           |  R-PPYZFNR0006 |         |

**NEW**

# YAMAHA REAR FENDER / PARAFANGO POSTERIORE

| MODEL        | CC      | YEAR          | NOTES  | COLOR        |  | CODE          | PRICE   |         |
|--------------|---------|---------------|--|--------------|--|---------------|---------|---------|
| YZF          | 250     | 2014 > 2018   | OEM  | YZ Blue      |  | R-PPYZFBL0014 | € 31,95 |         |
|              |         |               |  | White        |  | R-PPYZFBN0014 |         |         |
|              |         |               |  | Black        |  | R-PPYZFNR0014 |         |         |
|              |         |               |  | Y Yellow     |  | R-PPYZFGY0014 |         |         |
|              |         |               |  | Neon Yellow  |  | R-PPYZFGF0014 |         |         |
|              |         |               |  | CR Red       |  | R-PPYZFRS0014 |         |         |
| YZF          | 250     | 2019 > 2023   | OEM<br>OEM<br>OEM - 2021 Monster Energy Edition  | YZ Blue      |  | R-PPYZFBL0018 | € 31,95 |         |
|              |         |               |  | White        |  | R-PPYZFBN0018 |         |         |
|              |         |               |  | Black        |  | R-PPYZFNR0018 |         |         |
|              |         |               |  | Y Yellow     |  | R-PPYZFGY0018 |         |         |
|              |         |               |  | Neon Yellow  |  | R-PPYZFGF0018 |         |         |
|              |         |               |  | Quantum Grey |  | R-PPYZFGR0018 |         |         |
| YZF          | 400-426 | 1998 > 2002   | OEM<br>Limited Edition   | YZ Blue      |  | R-PPYZ0BL9601 | € 31,95 |         |
|              |         |               |  | White        |  | R-PPYZ0BN9601 |         |         |
| YZF          | 450     | 2010 > 2013   | OEM 2010 and 2013<br>OEM 2010 > 2012<br>OEM 2011 > 2013  | White        |  | R-PPYZFBN0045 | € 29,95 |         |
|              |         |               |  | YZ Blue      |  | R-PPYZFBL0045 |         |         |
| YZF          | 450     | 2010 > 2013   | mud flap connector   | Black        |  | R-PPYZFNR0045 | € 31,95 |         |
| YZF          | 450     | 2014 > 2017   | OEM  | YZ Blue      |  | R-PPYZFBL0014 | € 31,95 |         |
|              |         |               |  | White        |  | R-PPYZFBN0014 |         |         |
|              |         |               |  | Black        |  | R-PPYZFNR0014 |         |         |
|              |         |               |  | Y Yellow     |  | R-PPYZFGY0014 |         |         |
|              |         |               |  | Neon Yellow  |  | R-PPYZFGF0014 |         |         |
|              |         |               |  | CR Red       |  | R-PPYZFRS0014 |         |         |
| YZF          | 450     | 2018 > 2022   | OEM<br>OEM   | YZ Blue      |  | R-PPYZFBL0018 | € 31,95 |         |
|              |         |               |  | White        |  | R-PPYZFBN0018 |         |         |
|              |         |               |  | Black        |  | R-PPYZFNR0018 |         |         |
|              |         |               |  | Y Yellow     |  | R-PPYZFGY0018 |         |         |
|              |         |               |  | Neon Yellow  |  | R-PPYZFGF0018 |         |         |
|              |         |               |  | Quantum Grey |  | R-PPYZFGR0018 |         |         |
| YZF          | 450     | 2023          | OEM<br>OEM - Monster Energy Edition  | YZ Blue      |  | R-PPYZFBL0023 | € 31,95 |         |
|              |         |               |  | White        |  | R-PPYZFBN0023 |         |         |
|              |         |               |  | Black        |  | R-PPYZFNR0023 |         |         |
|              |         |               |  | Quantum Grey |  | R-PPYZFGR0023 |         |         |
|              |         |               |  | YZ Blue      |  | R-PPWRFBL0015 |         | € 36,95 |
|              |         |               |  | White        |  | R-PPWRFBN0015 |         |         |
| Black        |         | R-PPWRFNR0015 |  |              |  |               |         |         |
| Y Yellow     |         | R-PPWRFY0015  |  |              |  |               |         |         |
| YZ Blue      |         | R-PPYZFBL0018 | € 31,95  |              |  |               |         |         |
| White        |         | R-PPYZFBN0018 |  |              |  |               |         |         |
| Black        |         | R-PPYZFNR0018 |  |              |  |               |         |         |
| Y Yellow     |         | R-PPYZFGY0018 |  |              |  |               |         |         |
| Neon Yellow  |         | R-PPYZFGF0018 |  |              |  |               |         |         |
| Quantum Grey |         | R-PPYZFGR0018 |  |              |  |               |         |         |
| YZ-FX        | 450     | 2015 > 2018   | OEM - LED not included<br>LED not included<br>LED not included   | YZ Blue      |  | R-PPWRFBL0015 | € 36,95 |         |
|              |         |               |  | White        |  | R-PPWRFBN0015 |         |         |
|              |         |               |  | Black        |  | R-PPWRFNR0015 |         |         |
|              |         |               |  | Y Yellow     |  | R-PPWRFY0015  |         |         |
| WRF          | 250     | 2001-2002     | OEM  | YZ Blue      |  | R-PPYZ0BL9601 | € 31,95 |         |
|              |         |               |  | White        |  | R-PPYZ0BN9601 |         |         |
|              |         |               |  | Black        |  | R-PPYZ0NR9601 |         |         |
|              |         |               |  | YZ Blue      |  | R-PPWRFBL0300 |         | € 31,95 |
| White        |         | R-PPWRFBN0300 |  |              |  |               |         |         |
| Black        |         | R-PPWRFNR0300 |  |              |  |               |         |         |
| WRF          | 250-450 | 2003 > 2006   | OEM  | YZ Blue      |  | R-PPYZ0BL9601 | € 31,95 |         |
|              |         |               |  | White        |  | R-PPYZ0BN9601 |         |         |
|              |         |               |  | Black        |  | R-PPYZ0NR9601 |         |         |
| WRF          | 250     | 2007 > 2014   | OEM 2013 - LED not included<br>OEM 2007 > 2012 - LED not included<br>LED not included  | White        |  | R-PPWRFBN0007 | € 31,95 |         |
|              |         |               |  | YZ Blue      |  | R-PPWRFBL0007 |         |         |
|              |         |               |  | Black        |  | R-PPWRFNR0007 |         |         |
| WRF          | 250     | 2015 > 2019   | OEM - LED not included<br>LED not included<br>LED not included   | YZ Blue      |  | R-PPWRFBL0015 | € 36,95 |         |
|              |         |               |  | White        |  | R-PPWRFBN0015 |         |         |
|              |         |               |  | Black        |  | R-PPWRFNR0015 |         |         |
|              |         |               |  | Y Yellow     |  | R-PPWRFY0015  |         |         |
| WRF          | 450     | 2007 > 2015   | OEM 2013 > 2015 - LED not included<br>OEM 2007 > 2012 - LED not included<br>LED not included   | White        |  | R-PPWRFBN0007 | € 31,95 |         |
|              |         |               |  | YZ Blue      |  | R-PPWRFBL0007 |         |         |
|              |         |               |  | Black        |  | R-PPWRFNR0007 |         |         |
| WRF          | 450     | 2016 > 2018   | OEM - LED not included<br>LED not included<br>LED not included<br>LED not included   | YZ Blue      |  | R-PPWRFBL0015 | € 36,95 |         |
|              |         |               |  | Y Yellow     |  | R-PPWRFY0015  |         |         |
|              |         |               |  | White        |  | R-PPWRFBN0015 |         |         |
|              |         |               |  | Black        |  | R-PPWRFNR0015 |         |         |
|              |         |               |  | YZ Blue      |  | R-PPYZFBL0018 |         | € 31,95 |
| White        |         | R-PPYZFBN0018 |  |              |  |               |         |         |
| Black        |         | R-PPYZFNR0018 |  |              |  |               |         |         |
| Y Yellow     |         | R-PPYZFGY0018 |  |              |  |               |         |         |
| Neon Yellow  |         | R-PPYZFGF0018 |  |              |  |               |         |         |
| YZ-FX / WRF  | 450     | 2019 > 2023   | OEM - Fender motocross version<br>OEM - Fender motocross version<br>Fender motocross version<br>Fender motocross version<br>Limited Edition - Fender motocross version | YZ Blue      |  | R-PPYZFBL0018 | € 31,95 |         |
|              |         |               |  | White        |  | R-PPYZFBN0018 |         |         |
|              |         |               |  | Black        |  | R-PPYZFNR0018 |         |         |
|              |         |               |  | Y Yellow     |  | R-PPYZFGY0018 |         |         |
|              |         |               |  | Neon Yellow  |  | R-PPYZFGF0018 |         |         |
| YZ-FX / WRF  | 450     | 2019 > 2023   | OEM - Fender motocross version<br>OEM - Fender motocross version<br>Fender motocross version<br>Fender motocross version<br>Limited Edition - Fender motocross version | Quantum Grey |  | R-PPYZFGR0018 | € 31,95 |         |
|              |         |               |  | YZ Blue      |  | R-PPYZFBL0018 |         |         |
|              |         |               |  | White        |  | R-PPYZFBN0018 |         |         |
|              |         |               |  | Black        |  | R-PPYZFNR0018 |         |         |
|              |         |               |  | Y Yellow     |  | R-PPYZFGY0018 |         |         |

**NEW**



R-CVYZFBL0018



R-CVYZFBLNRU1

AVAILABLE COLORS



**OEM** original color - fluorescent color

| MODEL   | CC      | YEAR        | NOTES  | COLOR             | CODE          | PRICE    |
|---------|---------|-------------|--|-------------------|---------------|----------|
| YZ      | 65      | 2018 > 2023 | OEM  | YZ Blue           | R-CVYZ0BL0065 | € 49,95  |
|         |         |             |  | Black             | R-CVYZ0NR0065 |          |
| YZ      | 85      | 2002 > 2014 | OEM - Single   | YZ Blue           | R-CVYZ0BL0085 | € 31,95  |
| YZ      | 85      | 2015 > 2021 | OEM - Single - adaptable to 2002 > 2014                        | YZ Blue           | R-CVYZ0BL1585 | € 39,95  |
| YZ      | 85      | 2022-2023   | OEM  | YZ Blue           | R-CVYZ0BL2285 | € 57,95  |
|         |         |             |  | White             | R-CVYZ0BN2285 |          |
|         |         |             |  | Black             | R-CVYZ0NR2285 |          |
|         |         |             |  | Quantum Grey      | R-CVYZ0GR2285 |          |
| YZ / WR | 125-250 | 1996 > 2001 | OEM  | YZ Blue           | R-CVYZ0BL9601 | € 57,95  |
| YZ      | 125-250 | 2002 > 2014 | OEM  | YZ Blue           | R-CVYZ0BL0203 | € 57,95  |
|         |         |             |  | White             | R-CVYZ0BN0203 |          |
|         |         |             |  | Black             | R-CVYZ0NR0203 |          |
| YZ-X    | 125     | 2020 > 2021 | OEM  | YZ Blue           | R-CVYZ0BL0015 | € 57,95  |
|         |         |             |  | White             | R-CVYZ0BN0015 |          |
|         |         |             |  | Black             | R-CVYZ0NR0015 |          |
| YZ-X    | 250     | 2016 > 2021 | OEM - adaptable to 2002 > 2014                                 | YZ Blue           | R-CVYZ0BL0015 | € 57,95  |
|         |         |             |  | White             | R-CVYZ0BN0015 |          |
|         |         |             |  | Black             | R-CVYZ0NR0015 |          |
| YZ-X    | 125-250 | 2023        | OEM  | YZ Blue           | R-CVYZ0BL0022 | € 57,95  |
|         |         |             |  | White             | R-CVYZ0BN0022 |          |
|         |         |             |  | Black             | R-CVYZ0NR0022 |          |
|         |         |             |  | Quantum Grey      | R-CVYZ0GR0022 |          |
| YZ      | 125-250 | 2015 > 2021 | OEM - adaptable to 2002 > 2014                                 | YZ Blue           | R-CVYZ0BL0015 | € 57,95  |
|         |         |             |  | White             | R-CVYZ0BN0015 |          |
|         |         |             |  | Black             | R-CVYZ0NR0015 |          |
| YZ      | 125-250 | 2022-2023   | OEM  | YZ Blue           | R-CVYZ0BL0022 | € 57,95  |
|         |         |             |  | White             | R-CVYZ0BN0022 |          |
|         |         |             |  | Black             | R-CVYZ0NR0022 |          |
|         |         |             |  | Quantum Grey      | R-CVYZ0GR0022 |          |
| YZF     | 250     | 2001-2002   | OEM  | YZ Blue           | R-CVYZFBL9902 | € 57,95  |
|         |         |             |  | White             | R-CVYZFBN9902 |          |
| YZF     | 250     | 2010 > 2013 | OEM 2010 and 2013<br>OEM 2010<br>OEM 2011 > 2013               | White-Black       | R-CVYZFBNNR25 | € 65,95  |
|         |         |             |  | YZ Blue-Black     | R-CVYZFBLNR25 |          |
|         |         |             |  | YZ Blue-White     | R-CVYZFBLBN25 |          |
|         |         |             |  | White             | R-CVYZFBN0025 |          |
|         |         |             |  | Black             | R-CVYZFNR0025 |          |
|         |         |             |  | Black-White       | R-CVYZFNRBN25 |          |
| YZF     | 250-450 | 2003 > 2005 | OEM  | YZ Blue           | R-CVYZFBL0300 | € 57,95  |
|         |         |             |  | White             | R-CVYZFBN0300 |          |
|         |         |             |  | Y Yellow          | R-CVYZFGY0300 |          |
|         |         |             |  | Black             | R-CVYZFNR0300 |          |
| YZF     | 250-450 | 2006 > 2009 | OEM  | YZ Blue           | R-CVYZFBL0006 | € 57,95  |
|         |         |             |  | White             | R-CVYZFBN0006 |          |
|         |         |             |  | Y Yellow          | R-CVYZFGY0006 |          |
|         |         |             |  | Black             | R-CVYZFNR0006 |          |
| YZF     | 250     | 2014 > 2018 | OEM - Upper<br>OEM - Upper<br>Upper<br>Upper<br>Upper<br>Upper | YZ Blue-Black     | R-CVYZFBLNRU1 | € 117,95 |
|         |         |             |  | White-Black       | R-CVYZFBNNRU1 |          |
|         |         |             |  | Black             | R-CVYZFNR00U1 |          |
|         |         |             |  | Y Yellow          | R-CVYZFGY00U1 |          |
|         |         |             |  | Neon Yellow-Black | R-CVYZFGF00U1 |          |
|         |         |             |  | CR Red-Black      | R-CVYZFRS00U1 |          |

# YAMAHA RADIATOR SHROUDS / CONVOGLIATORI ARIA RADIATORE



**OEM** original color - fluorescent color

| MODEL       | CC  | YEAR        | NOTES  | COLOR             | CODE | PRICE         |          |         |
|-------------|-----|-------------|--|-------------------|------|---------------|----------|---------|
| YZF         | 250 | 2014 > 2018 | OEM 2014 > 2017 - Lower<br>Lower<br>Lower<br>OEM 2018 - Lower<br>Lower | White             |      | R-CVYZFBNL014 | € 65,95  |         |
|             |     |             |  | Black             |      | R-CVYZFNR014  |          |         |
|             |     |             |  | Neon Yellow       |      | R-CVYZFGF014  |          |         |
|             |     |             |  | YZ Blue           |      | R-CVYZFBLL014 |          |         |
|             |     |             |  | CR Red            |      | R-CVYZFRS014  |          |         |
| YZF         | 250 | 2019 > 2023 | OEM<br>OEM<br><br>Limited Edition                                      | White             |      | R-CVYZFBN0018 | € 65,95  |         |
|             |     |             |  | YZ Blue           |      | R-CVYZFBL0018 |          |         |
|             |     |             |  | Black             |      | R-CVYZFNR0018 |          |         |
|             |     |             |  | Neon Yellow       |      | R-CVYZFGF0018 |          |         |
|             |     |             |  | YZ Yellow         |      | R-CVYZFGY0018 |          |         |
|             |     |             |  | Quantum Grey      |      | R-CVYZFGR0018 |          |         |
|             |     |             |  | YZ Blue           |      | R-CVYZFBL9899 |          | € 57,95 |
|             |     |             |  | YZ Blue           |      | R-CVYZFBL9902 |          | € 57,95 |
|             |     |             |  | White             |      | R-CVYZFBN9902 |          |         |
|             |     |             |  | White             |      | R-CVYZFBNL010 |          | € 36,95 |
| YZF         | 450 | 2010 > 2013 | OEM 2011 > 2013 - Lower<br>OEM 2010 - Lower                            | Black             |      | R-CVYZFNR010  | € 62,95  |         |
|             |     |             |  | White-Black       |      | R-CVYZFBNNRU0 |          |         |
| YZF         | 450 | 2010 > 2013 | OEM 2010 and 2013 - Upper<br>OEM 2010 - Upper<br>OEM 2011-2012 - Upper | YZ Blue-Black     |      | R-CVYZFBLNRU0 | € 117,95 |         |
|             |     |             |  | Black-White       |      | R-CVYZFBNRU0  |          |         |
|             |     |             |  | Black             |      | R-CVYZFNR00U1 |          |         |
| YZF         | 450 | 2014 > 2017 | OEM - Upper<br>OEM - Upper<br>Upper<br>Upper<br>Upper                  | YZ Blue-Black     |      | R-CVYZFBLNRU1 | € 117,95 |         |
|             |     |             |  | White-Black       |      | R-CVYZFBNNRU1 |          |         |
|             |     |             |  | Black             |      | R-CVYZFNR00U1 |          |         |
|             |     |             |  | Y Yellow-Black    |      | R-CVYZFGY00U1 |          |         |
|             |     |             |  | Neon Yellow-Black |      | R-CVYZFGF00U1 |          |         |
| YZF         | 450 | 2014 > 2017 | OEM - Lower<br>Lower<br>Lower<br>Lower                                 | CR Red-Black      |      | R-CVYZFRS00U1 | € 65,95  |         |
|             |     |             |  | White             |      | R-CVYZFBNL014 |          |         |
|             |     |             |  | Black             |      | R-CVYZFNR014  |          |         |
|             |     |             |  | Neon Yellow       |      | R-CVYZFGF014  |          |         |
|             |     |             |  | YZ Blue           |      | R-CVYZFBLL014 |          |         |
| YZF         | 450 | 2018 > 2022 | OEM<br>OEM   | CR Red            |      | R-CVYZFRS014  | € 65,95  |         |
|             |     |             |  | YZ Blue           |      | R-CVYZFBL0018 |          |         |
|             |     |             |  | White             |      | R-CVYZFBN0018 |          |         |
|             |     |             |  | Black             |      | R-CVYZFNR0018 |          |         |
|             |     |             |  | Neon Yellow       |      | R-CVYZFGF0018 |          |         |
| YZF         | 450 | 2023        | OEM<br>OEM - 2023 Monster Energy Edition                               | YZ Yellow         |      | R-CVYZFGY0018 | € 65,95  |         |
|             |     |             |  | Quantum Grey      |      | R-CVYZFGR0018 |          |         |
|             |     |             |  | YZ Blue           |      | R-CVYZFBL0023 |          |         |
|             |     |             |  | White             |      | R-CVYZFBN0023 |          |         |
|             |     |             |  | Black             |      | R-CVYZFNR0023 |          |         |
| YZ-FX       | 450 | 2016 > 2018 | OEM - Upper<br>Upper<br>Upper<br>Upper<br>Upper                        | Quantum Grey      |      | R-CVYZFGR0023 | € 117,95 |         |
|             |     |             |  | YZ Blue-Black     |      | R-CVYZFBLNRU1 |          |         |
|             |     |             |  | White-Black       |      | R-CVYZFBNNRU1 |          |         |
|             |     |             |  | Neon Yellow-Black |      | R-CVYZFGF00U1 |          |         |
|             |     |             |  | YZ Yellow-Black   |      | R-CVYZFGY00U1 |          |         |
| YZ-FX       | 250 | 2015 > 2019 | OEM - Upper<br>Upper<br>Upper<br>Upper<br>Upper                        | Black             |      | R-CVYZFNR00U1 | € 117,95 |         |
|             |     |             |  | CR Red-Black      |      | R-CVYZFRS00U1 |          |         |
|             |     |             |  | Y Yellow-Black    |      | R-CVYZFGY00U1 |          |         |
|             |     |             |  | Neon Yellow-Black |      | R-CVYZFGF00U1 |          |         |
|             |     |             |  | CR Red-Black      |      | R-CVYZFRS00U1 |          |         |
| YZ-FX       | 250 | 2015 > 2019 | OEM - Lower<br>Lower<br>Lower<br>Lower                                 | White             |      | R-CVYZFBNL014 | € 65,95  |         |
|             |     |             |  | YZ Blue           |      | R-CVYZFBLL014 |          |         |
|             |     |             |  | Neon Yellow       |      | R-CVYZFGF014  |          |         |
|             |     |             |  | Black             |      | R-CVYZFNR014  |          |         |
|             |     |             |  | CR Red            |      | R-CVYZFRS014  |          |         |
| YZ-FX / WRF | 250 | 2020 > 2023 | OEM  | YZ Blue           |      | R-CVYZFBL0018 | € 65,95  |         |
|             |     |             |  | Black             |      | R-CVYZFNR0018 |          |         |
|             |     |             |  | Neon Yellow       |      | R-CVYZFGF0018 |          |         |
|             |     |             |  | YZ Yellow         |      | R-CVYZFGY0018 |          |         |
|             |     |             |  | White             |      | R-CVYZFBN0018 |          |         |
| YZ-FX       | 450 | 2016 > 2018 | OEM - Lower<br>Lower<br>Lower<br>Lower                                 | Quantum Grey      |      | R-CVYZFGR0018 | € 65,95  |         |
|             |     |             |  | White             |      | R-CVYZFBNL014 |          |         |
|             |     |             |  | YZ Blue           |      | R-CVYZFBLL014 |          |         |
|             |     |             |  | Neon Yellow       |      | R-CVYZFGF014  |          |         |
|             |     |             |  | Black             |      | R-CVYZFNR014  |          |         |
| YZ-FX / WRF | 450 | 2019 > 2023 | OEM  | CR Red            |      | R-CVYZFRS014  | € 65,95  |         |
|             |     |             |  | YZ Blue           |      | R-CVYZFBL0018 |          |         |
|             |     |             |  | Black             |      | R-CVYZFNR0018 |          |         |
|             |     |             |  | Neon Yellow       |      | R-CVYZFGF0018 |          |         |
|             |     |             |  | YZ Yellow         |      | R-CVYZFGY0018 |          |         |
| YZ-FX       | 450 | 2016 > 2018 | OEM - Lower<br>Lower<br>Lower<br>Lower                                 | White             |      | R-CVYZFBN0018 | € 65,95  |         |
|             |     |             |  | Quantum Grey      |      | R-CVYZFGR0018 |          |         |
|             |     |             |  | White             |      | R-CVYZFBNL014 |          |         |
|             |     |             |  | YZ Blue           |      | R-CVYZFBLL014 |          |         |
|             |     |             |  | Neon Yellow       |      | R-CVYZFGF014  |          |         |
| YZ-FX / WRF | 450 | 2019 > 2023 | OEM  | Black             |      | R-CVYZFNR014  | € 65,95  |         |
|             |     |             |  | CR Red            |      | R-CVYZFRS014  |          |         |
|             |     |             |  | YZ Blue           |      | R-CVYZFBL0018 |          |         |
|             |     |             |  | Black             |      | R-CVYZFNR0018 |          |         |
|             |     |             |  | Neon Yellow       |      | R-CVYZFGF0018 |          |         |
| YZ-FX       | 450 | 2016 > 2018 | OEM - Lower<br>Lower<br>Lower<br>Lower                                 | YZ Yellow         |      | R-CVYZFGY0018 | € 65,95  |         |
|             |     |             |  | White             |      | R-CVYZFBN0018 |          |         |
|             |     |             |  | Quantum Grey      |      | R-CVYZFGR0018 |          |         |
|             |     |             |  | White             |      | R-CVYZFBNL014 |          |         |
|             |     |             |  | YZ Blue           |      | R-CVYZFBLL014 |          |         |
| YZ-FX / WRF | 450 | 2019 > 2023 | OEM  | Neon Yellow       |      | R-CVYZFGF014  | € 65,95  |         |
|             |     |             |  | Black             |      | R-CVYZFNR014  |          |         |
|             |     |             |  | CR Red            |      | R-CVYZFRS014  |          |         |
|             |     |             |  | YZ Blue           |      | R-CVYZFBL0018 |          |         |
|             |     |             |  | Black             |      | R-CVYZFNR0018 |          |         |
| YZ-FX       | 450 | 2016 > 2018 | OEM - Lower<br>Lower<br>Lower<br>Lower                                 | Neon Yellow       |      | R-CVYZFGF0018 | € 65,95  |         |
|             |     |             |  | YZ Yellow         |      | R-CVYZFGY0018 |          |         |
|             |     |             |  | White             |      | R-CVYZFBN0018 |          |         |
|             |     |             |  | Quantum Grey      |      | R-CVYZFGR0018 |          |         |
|             |     |             |  | White             |      | R-CVYZFBNL014 |          |         |
| YZ-FX / WRF | 450 | 2019 > 2023 | OEM  | YZ Blue           |      | R-CVYZFBLL014 | € 65,95  |         |
|             |     |             |  | Neon Yellow       |      | R-CVYZFGF014  |          |         |
|             |     |             |  | Black             |      | R-CVYZFNR014  |          |         |
|             |     |             |  | CR Red            |      | R-CVYZFRS014  |          |         |
|             |     |             |  | YZ Blue           |      | R-CVYZFBL0018 |          |         |
| YZ-FX       | 450 | 2016 > 2018 | OEM - Lower<br>Lower<br>Lower<br>Lower                                 | Black             |      | R-CVYZFNR0018 | € 65,95  |         |
|             |     |             |  | Neon Yellow       |      | R-CVYZFGF0018 |          |         |
|             |     |             |  | YZ Yellow         |      | R-CVYZFGY0018 |          |         |
|             |     |             |  | White             |      | R-CVYZFBN0018 |          |         |
|             |     |             |  | Quantum Grey      |      | R-CVYZFGR0018 |          |         |
| YZ-FX / WRF | 450 | 2019 > 2023 | OEM  | White             |      | R-CVYZFBN0018 | € 65,95  |         |
|             |     |             |  | Quantum Grey      |      | R-CVYZFGR0018 |          |         |
|             |     |             |  | White             |      | R-CVYZFBNL014 |          |         |
|             |     |             |  | YZ Blue           |      | R-CVYZFBLL014 |          |         |
|             |     |             |  | Neon Yellow       |      | R-CVYZFGF014  |          |         |

**NEW**



**OEM** original color - fluorescent color

| MODEL | CC      | YEAR        | NOTES       | COLOR             |  | CODE          | PRICE    |
|-------|---------|-------------|-------------|-------------------|--|---------------|----------|
| WRF   | 250     | 2001-2002   | OEM         | YZ Blue           |  | R-CVYZFBL9902 | € 57,95  |
|       |         |             |             | White             |  | R-CVYZFBN9902 |          |
| WRF   | 250     | 2007 > 2014 | OEM         | YZ Blue           |  | R-CVWRFBL0007 | € 65,95  |
|       |         |             |             | White             |  | R-CVWRFBN0007 |          |
|       |         |             |             | Black             |  | R-CVWRFNR0007 |          |
| WRF   | 250     | 2015 > 2019 | OEM - Upper | YZ Blue-Black     |  | R-CVYZFBLNRU1 | € 117,95 |
|       |         |             | OEM         | White-Black       |  | R-CVYZFBNNRU1 |          |
|       |         |             | Upper       | Black             |  | R-CVYZFNR00U1 |          |
|       |         |             | Upper       | Y Yellow-Black    |  | R-CVYZFGY00U1 |          |
|       |         |             | Upper       | Neon Yellow-Black |  | R-CVYZFGF00U1 |          |
|       |         |             | Upper       | CR Red-Black      |  | R-CVYZFRS00U1 |          |
| WRF   | 250     | 2015 > 2019 | OEM - Lower | White             |  | R-CVYZFBNLO14 | € 65,95  |
|       |         |             | Lower       | Black             |  | R-CVYZFNRLO14 |          |
|       |         |             | Lower       | Neon Yellow       |  | R-CVYZFGFLO14 |          |
|       |         |             | Lower       | YZ Blue           |  | R-CVYZFBLL014 |          |
|       |         |             | Lower       | CR Red            |  | R-CVYZFRSLO14 |          |
| WRF   | 250-450 | 2003-2004   | OEM         | YZ Blue           |  | R-CVWRFBL0304 | € 57,95  |
| WRF   | 250-450 | 2005-2006   | OEM         | YZ Blue           |  | R-CVYZFBL0300 | € 57,95  |
|       |         |             |             | White             |  | R-CVYZFBN0300 |          |
|       |         |             |             | Y Yellow          |  | R-CVYZFGY0300 |          |
|       |         |             |             | Black             |  | R-CVYZFNR0300 |          |
| WRF   | 400     | 1999        | OEM         | YZ Blue           |  | R-CVYZFBL9899 | € 57,95  |
| WRF   | 400-426 | 2000 > 2002 | OEM         | YZ Blue           |  | R-CVYZFBL9902 | € 57,95  |
|       |         |             |             | White             |  | R-CVYZFBN9902 |          |
| WRF   | 450     | 2007 > 2011 | OEM         | YZ Blue           |  | R-CVWRFBL0007 | € 65,95  |
|       |         |             |             | White             |  | R-CVWRFBN0007 |          |
|       |         |             |             | Black             |  | R-CVWRFNR0007 |          |
| WRF   | 450     | 2012 > 2015 | OEM         | YZ Blue-White     |  | R-CVYZFBLBN25 | € 65,95  |
|       |         |             |             | YZ Blue-Black     |  | R-CVYZFBLNR25 |          |
|       |         |             |             | White-Black       |  | R-CVYZFBNNR25 |          |
|       |         |             |             | White             |  | R-CVYZFBN0025 |          |
|       |         |             |             | Black             |  | R-CVYZFNR0025 |          |
|       |         |             |             | Black-White       |  | R-CVYZFNRBN25 |          |
| WRF   | 450     | 2016 > 2018 | OEM - Upper | YZ Blue-Black     |  | R-CVYZFBLNRU1 | € 117,95 |
|       |         |             | Upper       | White-Black       |  | R-CVYZFBNNRU1 |          |
|       |         |             | Upper       | Y Yellow-Black    |  | R-CVYZFGY00U1 |          |
|       |         |             | Upper       | Black             |  | R-CVYZFNR00U1 |          |
|       |         |             | Upper       | Neon Yellow-Black |  | R-CVYZFGF00U1 |          |
|       |         |             | Upper       | CR Red-Black      |  | R-CVYZFRS00U1 |          |
| WRF   | 450     | 2016 > 2018 | OEM - Lower | White             |  | R-CVYZFBNLO14 | € 65,95  |
|       |         |             | Lower       | Black             |  | R-CVYZFNRLO14 |          |
|       |         |             | Lower       | Neon Yellow       |  | R-CVYZFGFLO14 |          |
|       |         |             | Lower       | YZ Blue           |  | R-CVYZFBLL014 |          |
|       |         |             | Lower       | CR Red            |  | R-CVYZFRSLO14 |          |



R-CVYZFGY00U1

**NEON**



R-CVYZFGF00U1



R-CVYZFBLNRU1



R-CVYZFNR00U1





## AVAILABLE COLORS

■ YZ Blue   
 ■ Black   
 ■ White   
 ■ Neon Yellow   
 ■ Y Yellow

**OEM** original color - fluorescent color

| MODEL     | CC  | YEAR        | NOTES      | COLOR        | CODE | PRICE                 |
|-----------|-----|-------------|------------|--------------|------|-----------------------|
| YZF       | 250 | 2019 > 2020 | OEM<br>OEM | YZ Blue      |      | R-COVSRYZFBL1 € 29,95 |
|           |     |             |            | White        |      | R-COVSRYZFBN1         |
|           |     |             |            | Black        |      | R-COVSRYZFNR1         |
|           |     |             |            | Neon Yellow  |      | R-COVSRYZFGF1         |
|           |     |             |            | YZ Yellow    |      | R-COVSRYZFGY1         |
| YZF       | 250 | 2021 > 2023 | OEM        | YZ Blue      |      | R-COVSRYZFBL2 € 32,95 |
|           |     |             |            | White        |      | R-COVSRYZFBN2         |
|           |     |             |            | Black        |      | R-COVSRYZFNR2         |
|           |     |             |            | YZ Blue      |      | R-COVSRYZFBL1 € 29,95 |
|           |     |             |            | White        |      | R-COVSRYZFBN1         |
| YZ-FX     | 250 | 2019 > 2023 | OEM<br>OEM | YZ Blue      |      | R-COVSRYZFBL1 € 29,95 |
|           |     |             |            | White        |      | R-COVSRYZFBN1         |
|           |     |             |            | Black        |      | R-COVSRYZFNR1         |
|           |     |             |            | Neon Yellow  |      | R-COVSRYZFGF1         |
|           |     |             |            | YZ Yellow    |      | R-COVSRYZFGY1         |
| WRF       | 250 | 2020 > 2023 | OEM<br>OEM | YZ Blue      |      | R-COVSRYZFBL1 € 29,95 |
|           |     |             |            | White        |      | R-COVSRYZFBN1         |
|           |     |             |            | Black        |      | R-COVSRYZFNR1         |
|           |     |             |            | Neon Yellow  |      | R-COVSRYZFGF1         |
|           |     |             |            | YZ Yellow    |      | R-COVSRYZFGY1         |
| YZF       | 450 | 2018 > 2022 | OEM<br>OEM | YZ Blue      |      | R-COVSRYZFBL1 € 29,95 |
|           |     |             |            | White        |      | R-COVSRYZFBN1         |
|           |     |             |            | Black        |      | R-COVSRYZFNR1         |
|           |     |             |            | Neon Yellow  |      | R-COVSRYZFGF1         |
|           |     |             |            | YZ Yellow    |      | R-COVSRYZFGY1         |
| YZF       | 450 | 2023        | OEM        | YZ Blue      |      | R-COVSRYZFBL3 € 29,95 |
|           |     |             |            | White        |      | R-COVSRYZFBN3         |
|           |     |             |            | Black        |      | R-COVSRYZFNR3         |
|           |     |             |            | Quantum Grey |      | R-COVSRYZFR3          |
|           |     |             |            | YZ Blue      |      | R-COVSRYZFBL1 € 29,95 |
| WRF/YZ-FX | 450 | 2019 > 2023 | OEM        | YZ Blue      |      | R-COVSRYZFBL1 € 29,95 |
|           |     |             |            | White        |      | R-COVSRYZFBN1         |
|           |     |             |            | Black        |      | R-COVSRYZFNR1         |
|           |     |             |            | Neon Yellow  |      | R-COVSRYZFGF1         |
|           |     |             |            | YZ Yellow    |      | R-COVSRYZFGY1         |

**NEW**



R-COVSRYZFBN1



R-COVSRYZFGF1



R-COVSRYZFBL1



R-COVSRYZFNR1

**NEON**

# YAMAHA OVERSIZE RADIATOR LOUVERS / GRIGLIE RADIATORE MAGGIORATE



Total protection of the bottom part of the stock radiator, it fully covers the part that with the standard louver remains without a shield against ground and stones.

*Protezione totale della parte inferiore del radiatore di serie.*

*Copre integralmente la vaschetta che nella versione standard rimane invece esposta agli urti di terra e sassi.*

R-GRYZFBL0018

## AVAILABLE COLORS

YZ Blue    Black    White    Neon Yellow

OEM original color - ☀️ fluorescent color

| MODEL       | CC      | YEAR        | NOTES  | COLOR          | CODE            | PRICE   |
|-------------|---------|-------------|--|----------------|-----------------|---------|
| YZ          | 125-250 | 2022-2023   | OEM 2022 - adaptable to 2005>2021 modles<br>adaptable to 2005>2021 modles<br>adaptable to 2005>2021 modles<br>OEM 2023 - adaptable to 2005>2021 modles | Black          | ☐ R-GRYZONR0022 | € 36,95 |
|             |         |             |  | White          | ☐ R-GRYZOBN0022 |         |
|             |         |             |  | YZ Blue        | ■ R-GRYZ0BL0022 |         |
|             |         |             |  | Deep Blue      | ■ R-GRYZFDB0022 |         |
| YZ-X        | 125-250 | 2023        | OEM  | Black          | ☐ R-GRYZONR0022 | € 36,95 |
|             |         |             |  | White          | ☐ R-GRYZOBN0022 |         |
|             |         |             |  | YZ Blue        | ■ R-GRYZ0BL0022 |         |
|             |         |             |  | Deep Blue      | ■ R-GRYZFDB0022 |         |
| YZF         | 250     | 2019 > 2023 | OEM 2020-2021  | White          | ☐ R-GRYZFBN0018 | € 36,95 |
|             |         |             |  | Neon Yellow ☀️ | ■ R-GRYZFGF0018 |         |
|             |         |             |  | Black          | ■ R-GRYZFN0018  |         |
|             |         |             |  | YZ Blue        | ■ R-GRYZFBL0018 |         |
| YZ-FX / WRF | 250     | 2020 > 2023 | OEM 2023<br>OEM 2020-2021  | Deep Blue      | ■ R-GRYZFDB0018 | € 36,95 |
|             |         |             |  | White          | ☐ R-GRYZFBN0018 |         |
|             |         |             |  | Neon Yellow ☀️ | ■ R-GRYZFGF0018 |         |
|             |         |             |  | Black          | ■ R-GRYZFN0018  |         |
| YZF         | 450     | 2018 > 2022 | OEM 2023<br>OEM 2020-2021  | YZ Blue        | ■ R-GRYZFBL0018 | € 36,95 |
|             |         |             |  | Deep Blue      | ■ R-GRYZFDB0018 |         |
|             |         |             |  | White          | ☐ R-GRYZFBN0018 |         |
|             |         |             |  | Neon Yellow ☀️ | ■ R-GRYZFGF0018 |         |
| YZF         | 450     | 2023        | OEM 2023   | Black          | ■ R-GRYZFN0018  | € 36,95 |
|             |         |             |  | YZ Blue        | ■ R-GRYZFBL0023 |         |
|             |         |             |  | White          | ☐ R-GRYZFBN0023 |         |
|             |         |             |  | Deep Blue      | ■ R-GRYZFDB0023 |         |
| WRF / YZ-FX | 450     | 2019 > 2023 | OEM<br>OEM 2020-2021   | White          | ☐ R-GRYZFBN0018 | € 36,95 |
|             |         |             |  | Neon Yellow ☀️ | ■ R-GRYZFGF0018 |         |
|             |         |             |  | Black          | ■ R-GRYZFN0018  |         |
|             |         |             |  | YZ Blue        | ■ R-GRYZFBL0018 |         |
| WRF / YZ-FX | 450     | 2019 > 2023 | OEM 2023   | Deep Blue      | ■ R-GRYZFDB0018 | € 36,95 |
|             |         |             |  | White          | ☐ R-GRYZFBN0018 |         |
|             |         |             |  | Neon Yellow ☀️ | ■ R-GRYZFGF0018 |         |



R-GRYZFBL0018



R-GRYZFN0018

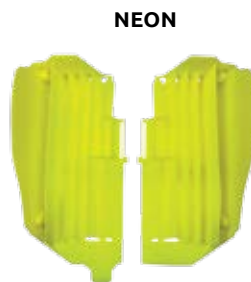

NEON





R-FIYZFBNNR14



R-FIYZFBLNR18

AVAILABLE COLORS



OEM original color - fluorescent color

















































| MODEL   | CC      | YEAR        | NOTES                                  | COLOR              | CODE           | PRICE   |
|---------|---------|-------------|--|--------------------|----------------|---------|
| YZ      | 65      | 2018 > 2023 | OEM 2018-2020<br>OEM 2021-2023         | White              | R-FIYZ0BN0065  | € 49,95 |
|         |         |             |  | YZ Blue            | R-FIYZ0BL0065  |         |
|         |         |             |  | Black              | R-FIYZ0NR0065  |         |
| YZ      | 85      | 2002 > 2014 | OEM                                    | White              | R-FIYZ0BN0085  | € 49,95 |
| YZ      | 85      | 2015 > 2021 | OEM - Bi-Color<br>OEM 2021             | White-Black        | R-FIYZ0BNR1585 | € 65,95 |
| YZ      | 85      | 2022-2023   | OEM                                    | YZ Blue            | R-FIYZ0BL2285  | € 65,95 |
|         |         |             |  | White              | R-FIYZ0BN2285  |         |
|         |         |             |  | Black              | R-FIYZ0NR2285  |         |
|         |         |             |  | Quantum Grey       | R-FIYZ0GR2285  |         |
|         |         |             |  | White              | R-FIYZ0BN9601  |         |
| YZ / WR | 125-250 | 1996 > 2001 | OEM                                    | White              | R-FIYZ0BN0203  | € 57,95 |
| YZ      | 125-250 | 2002 > 2014 | OEM                                    | Black              | R-FIYZ0NR0203  |         |
| YZ      | 125-250 | 2015 > 2021 | OEM                                    | White              | R-FIYZ0BN0015  | € 52,95 |
|         |         |             |  | YZ Blue            | R-FIYZ0BL0015  |         |
|         |         |             |  | Black              | R-FIYZ0NR0015  |         |
| YZ      | 125-250 | 2022-2023   | OEM                                    | YZ Blue            | R-FIYZ0BL0022  | € 57,95 |
|         |         |             |  | White              | R-FIYZ0BN0022  |         |
|         |         |             |  | Black              | R-FIYZ0NR0022  |         |
|         |         |             |  | Quantum Grey       | R-FIYZ0GR0022  |         |
|         |         |             |  | White              | R-FIYZ0BN0015  |         |
| YZ-X    | 125     | 2020 > 2022 | OEM                                    | YZ Blue            | R-FIYZ0BL0015  |         |
| YZF     | 250     | 2001-2002   | OEM                                    | Black              | R-FIYZ0NR0015  |         |
|         |         |             |  | White              | R-FIYZFBN9802  | € 57,95 |
|         |         |             |  | White-Black        | R-FIYZFBNNR25  | € 65,95 |
| YZF     | 250     | 2010 > 2013 | OEM - Bi-Color<br>Bi-Color             | YZ Blue-Black      | R-FIYZFBLNR25  |         |
| YZF     | 250-450 | 2003 > 2005 | OEM                                    | Black              | R-FIYZFNR0025  |         |
|         |         |             |  | White              | R-FIYZFBN0300  | € 57,95 |
|         |         |             |  | Black              | R-FIYZFNR0300  |         |
| YZF     | 250-450 | 2006 > 2009 | OEM                                    | White              | R-FIYZFBN0006  | € 65,95 |
|         |         |             |  | Black              | R-FIYZFNR0006  |         |
|         |         |             |  | White-Black        | R-FIYZFBNNR14  | € 75,95 |
| YZF     | 250     | 2014 > 2018 | OEM - Bi-Color                         | Black              | R-FIYZFNR0014  |         |
|         |         |             |  | Bi-Color           | R-FIYZFBLNR14  |         |
|         |         |             |  | Bi-Color           | R-FIYZFGFNR14  |         |
|         |         |             |  | CR Red-Black       | R-FIYZFRSNR14  |         |
|         |         |             |  | White-Black        | R-FIYZFBNNR18  | € 75,95 |
| YZF     | 250     | 2019 > 2023 | OEM - Bi-Color<br>Bi-Color<br>Bi-Color | YZ Blue-Black      | R-FIYZFBLNR18  |         |
|         |         |             |  | Neon Yellow-Black  | R-FIYZFGFNR18  |         |
|         |         |             |  | Black              | R-FIYZFNR0018  |         |
|         |         |             |  | Quantum Grey-Black | R-FIYZFGRNR18  |         |
|         |         |             |  | White              | R-FIYZFBN9802  | € 57,95 |
| YZF     | 400-426 | 1998 > 2002 | OEM                                    | White-Black        | R-FIYZFBNNR45  | € 75,95 |
| YZF     | 450     | 2010 > 2013 | OEM - Bi-Color<br>Bi-Color             | YZ Blue-Black      | R-FIYZFBLNR45  |         |
|         |         |             |  | Black              | R-FIYZFNR0045  |         |
|         |         |             |  | White-Black        | R-FIYZFBNNR14  | € 75,95 |
| YZF     | 450     | 2014 > 2017 | OEM - Bi-Color                         | Black              | R-FIYZFNR0014  |         |
|         |         |             |  | Bi-Color           | R-FIYZFBLNR14  |         |
|         |         |             |  | Bi-Color           | R-FIYZFGFNR14  |         |
|         |         |             |  | Bi-Color           | R-FIYZFRSNR14  |         |
|         |         |             |  | CR Red-Black       | R-FIYZFRSNR14  |         |
| YZF     | 450     | 2018 > 2022 | OEM - Bi-Color<br>Bi-Color<br>Bi-Color | White-Black        | R-FIYZFBNNR18  | € 75,95 |
|         |         |             |  | YZ Blue-Black      | R-FIYZFBLNR18  |         |
|         |         |             |  | Neon Yellow-Black  | R-FIYZFGFNR18  |         |
|         |         |             |  | Black              | R-FIYZFNR0018  |         |
|         |         |             |  | Quantum Grey-Black | R-FIYZFGRNR18  |         |
| YZF     | 450     | 2023        | Limited Edition<br>OEM                 | YZ Blue            | R-FIYZFBL0023  | € 75,95 |
|         |         |             |  | YZ Blue-White      | R-FIYZFBLN23   |         |
|         |         |             |  | YZ Blue-Black      | R-FIYZFBLNR23  |         |
|         |         |             |  | White              | R-FIYZFBN0023  |         |
|         |         |             |  | Black              | R-FIYZFNR0023  |         |
|         |         |             |  | Quantum grey       | R-FIYZFGR0023  |         |

**NEW**

OEM - Monster Energy Edition

# YAMAHA SIDE PANELS / TABELLE LATERALI PORTANUMERO

**OEM** original color -  fluorescent color

| MODEL       | CC          | YEAR        | NOTES   | COLOR   | CODE  | PRICE         |         |
|-------------|-------------|-------------|---|---|---|---------------|---------|
| YZ-FX       | 250         | 2015 > 2019 | OEM - Bi-Color<br>Bi-Color<br>Bi-Color                    | White-Black   |    | R-FIYZFBNNR14 | € 75,95 |
|             |             |             |   | YZ Blue-Black   |    | R-FIYZFBLNR14 |         |
|             |             |             |   | Neon Yellow-Black    |    | R-FIYZFGFNR14 |         |
|             |             |             |   | Black   |    | R-FIYZFNR0014 |         |
|             |             |             |   | CR Red-Black  |    | R-FIYZFRSNR14 |         |
| WRF/YZ-FX   | 250         | 2020 > 2023 | OEM - Bi-Color<br>Bi-Color<br>Bi-Color                    | White-Black   |    | R-FIYZFBNNR18 | € 75,95 |
|             |             |             |   | YZ Blue-Black   |    | R-FIYZFBLNR18 |         |
|             |             |             |   | Neon Yellow-Black    |    | R-FIYZFGFNR18 |         |
|             |             |             |   | Black   |    | R-FIYZFNR0018 |         |
|             |             |             |   | Quantum Grey-Black  |    | R-FIYZFGNR18  |         |
| YZ-FX       | 450         | 2016 > 2018 | Limited Edition<br>OEM - Bi-Color<br>Bi-Color<br>Bi-Color | White-Black   |    | R-FIYZFBNNR14 | € 75,95 |
|             |             |             |   | YZ Blue-Black   |    | R-FIYZFBLNR14 |         |
|             |             |             |   | Neon Yellow-Black    |    | R-FIYZFGFNR14 |         |
|             |             |             |   | Black   |    | R-FIYZFNR0014 |         |
|             |             |             |   | CR Red-Black  |    | R-FIYZFRSNR14 |         |
| YZ-FX / WRF | 450         | 2019 > 2023 | OEM - Bi-Color<br>Bi-Color<br>Bi-Color                    | White-Black   |    | R-FIYZFBNNR18 | € 75,95 |
|             |             |             |   | YZ Blue-Black   |    | R-FIYZFBLNR18 |         |
|             |             |             |   | Neon Yellow-Black    |    | R-FIYZFGFNR18 |         |
|             |             |             |   | Black   |    | R-FIYZFNR0018 |         |
|             |             |             |   | Quantum Grey-Black  |    | R-FIYZFGNR18  |         |
| YZ-X        | 250         | 2016 > 2022 | Limited Edition<br>OEM                                    | White   |    | R-FIYZ0BN0015 | € 52,95 |
|             |             |             |   | YZ Blue   |    | R-FIYZ0BL0015 |         |
|             |             |             |   | Black   |    | R-FIYZ0NR0015 |         |
|             |             |             |   |   |   |               |         |
| WRF         | 250         | 2007 > 2013 | OEM - Bi-Color  | White   |  | R-FIWRFBN0007 | € 65,95 |
|             |             |             |   | Black   |  | R-FIWRFN0007  |         |
| WRF         | 250         | 2015 > 2019 | OEM - Bi-Color<br>Bi-Color<br>Bi-Color<br>Bi-Color        | White-Black   |  | R-FIYZFBNNR14 | € 75,95 |
|             |             |             |   | Black   |  | R-FIYZFNR0014 |         |
|             |             |             |   | YZ Blue-Black   |  | R-FIYZFBLNR14 |         |
|             |             |             |   | Neon Yellow-Black  |  | R-FIYZFGFNR14 |         |
|             |             |             |   | CR Red-Black  |  | R-FIYZFRSNR14 |         |
| WRF         | 250-400-426 | 1998 > 2002 | OEM   | White   |  | R-FIYZFBN9802 | € 57,95 |
| WRF         | 250-450     | 2003 > 2006 | OEM   | White   |  | R-FIWRFBN0300 | € 65,95 |
|             |             |             |   | YZ Blue   |  | R-FIWRFBLO300 |         |
| WRF         | 450         | 2007 > 2011 | OEM - Bi-Color  | White   |  | R-FIWRFBN0007 | € 65,95 |
|             |             |             |   | Black   |  | R-FIWRFN0007  |         |
| WRF         | 450         | 2012 > 2015 | OEM   | White   |  | R-FIWRFBN0012 | € 65,95 |
|             |             |             |   | YZ Blue   |  | R-FIWRFBLO012 |         |
|             |             |             |   | Black   |  | R-FIWRFN0012  |         |
| WRF         | 450         | 2016 > 2018 | OEM - Bi-Color<br>Bi-Color<br>Bi-Color<br>Bi-Color        | White-Black   |  | R-FIYZFBNNR14 | € 75,95 |
|             |             |             |   | Black   |  | R-FIYZFNR0014 |         |
|             |             |             |   | YZ Blue-Black   |  | R-FIYZFBLNR14 |         |
|             |             |             |   | Neon Yellow-Black  |  | R-FIYZFGFNR14 |         |
|             |             |             |   | CR Red-Black  |  | R-FIYZFRSNR14 |         |

## YAMAHA AIRBOX SIDE PANELS / COPERCHI LATERALI CASSA FILTRO



R-FILCFYZBL15



R-FILCFYZBN15



R-FILCFYZNR15

### AVAILABLE COLORS

 YZ Blue  Black  White

**OEM** original color

| MODEL     | CC      | YEAR        | NOTES  | COLOR   | CODE  | PRICE           |         |
|-----------|---------|-------------|--|---------|---|-----------------|---------|
| YZ        | 125-250 | 2015 > 2021 | OEM<br>Adaptable to 02>14 models with 2015 side panels | Black   |  | R-FILCFYZNR15 * | € 43,95 |
|           |         |             |  | YZ Blue |  | R-FILCFYZBL15 * |         |
|           |         |             |  | White   |  | R-FILCFYZBN15 * |         |
| YZ-X      | 125     | 2020 > 2022 | OEM<br>Adaptable to 02>14 models with 2015 side panels | Black   |  | R-FILCFYZNR15 * | € 43,95 |
|           |         |             |  | YZ Blue |  | R-FILCFYZBL15 * |         |
|           |         |             |  | White   |  | R-FILCFYZBN15 * |         |
| YZ-X / WR | 250     | 2016 > 2022 | OEM<br>Adaptable to 02>14 models with 2015 side panels | Black   |  | R-FILCFYZNR15 * | € 43,95 |
|           |         |             |  | YZ Blue |  | R-FILCFYZBL15 * |         |
|           |         |             |  | White   |  | R-FILCFYZBN15 * |         |

\* must be used only with R-FIYZ0BL0015 - R-FIYZ0BN0015 - R-FIYZ0NR0015

# YAMAHA FRONT NUMBER PLATE / TABELLA PORTANUMERO ANTERIORE



R-TBYZFBL0023



R-TBYZFBL0018



R-SUPTABYZ915



Adapter to fits the front number plate **TBYZF\_\_0010**  
on models **YZ-YZF 125-250-400-426-450**  
**2002 > 2005**

## AVAILABLE COLORS

- YZ Blue
- Black
- White
- Neon Yellow
- CR Red
- Quantum Grey
- Y Yellow
- Ducati Neon Red

**OEM** original color - fluorescent color

| MODEL           | CC                  | YEAR          | NOTES   | COLOR           |     | CODE          | PRICE   |                                |             |  |               |         |
|-----------------|---------------------|---------------|---|-----------------|-----|---------------|---------|--------------------------------|-------------|--|---------------|---------|
| YZ              | 65                  | 2018 > 2023   | OEM 2015 > 2020<br>OEM 2021 > 2023                        | White           |     | R-TBYZ0BN1585 | € 39,95 |                                |             |  |               |         |
|                 |                     |               |   | YZ Blue         |     | R-TBYZ0BL1585 |         |                                |             |  |               |         |
|                 |                     |               |   | Black           |     | R-TBYZ0NR1585 |         |                                |             |  |               |         |
|                 |                     |               |   | Quantum Grey    |     | R-TBYZ0GR1585 |         |                                |             |  |               |         |
| YZ              | 80                  | 1993 > 2001   | OEM   | White           |     | R-TBYZ0BN0085 | € 23,95 |                                |             |  |               |         |
| YZ              | 85                  | 2002 > 2014   | OEM   | White           |     | R-TBYZ0BN0085 | € 23,95 |                                |             |  |               |         |
| YZ              | 85                  | 2015 > 2023   | OEM 2015 > 2020<br>OEM 2021 > 2023                        | White           |     | R-TBYZ0BN1585 | € 39,95 |                                |             |  |               |         |
|                 |                     |               |   | YZ Blue         |     | R-TBYZ0BL1585 |         |                                |             |  |               |         |
|                 |                     |               |   | Black           |     | R-TBYZ0NR1585 |         |                                |             |  |               |         |
|                 |                     |               |   | Quantum Grey    |     | R-TBYZ0GR1585 |         |                                |             |  |               |         |
| YZ              | 125-250             | 2000 > 2005   | OEM   | White           |     | R-TBYZFBN9603 | € 28,95 |                                |             |  |               |         |
|                 |                     |               |   | Black           |     | R-TBYZFNR9603 |         |                                |             |  |               |         |
| YZ              | 125-250             | 2006 > 2014   | OEM   | White           |     | R-TBYZ0BN0006 | € 28,95 |                                |             |  |               |         |
|                 |                     |               |   | YZ Blue         |     | R-TBYZ0BL0006 |         |                                |             |  |               |         |
|                 |                     |               |   | Black           |     | R-TBYZ0NR0006 |         |                                |             |  |               |         |
|                 |                     |               |   | Quantum Grey    |     | R-TBYZ0GR0006 |         |                                |             |  |               |         |
| YZ              | 125-250             | 2015 > 2021   | OEM 2015 > 2020<br>OEM 2021                               | White           |     | R-TBYZFBN0010 | € 28,95 |                                |             |  |               |         |
|                 |                     |               |   | YZ Blue         |     | R-TBYZFBL0010 |         |                                |             |  |               |         |
|                 |                     |               |   | Black           |     | R-TBYZFNR0010 |         |                                |             |  |               |         |
|                 |                     |               |   | Neon Yellow     |     | R-TBYZFGF0010 |         |                                |             |  |               |         |
|                 |                     |               |   | Y Yellow        |     | R-TBYZFGY0010 |         |                                |             |  |               |         |
|                 |                     |               |   | CR Red          |     | R-TBYZFRS0010 |         |                                |             |  |               |         |
|                 |                     |               |   | Quantum Grey    |     | R-TBYZFGR0010 |         |                                |             |  |               |         |
|                 |                     |               |   | Ducati Neon Red |     | R-TBYZFRD0010 |         |                                |             |  |               |         |
|                 |                     |               |   | Limited Edition |     |               |         |                                |             |  |               |         |
|                 |                     |               |   | Limited Edition |     |               |         |                                |             |  |               |         |
| YZ              | 125-250             | 2022-2023     | OEM   | White           |     | R-TBYZFBN0018 | € 28,95 |                                |             |  |               |         |
|                 |                     |               |   | YZ Blue         |     | R-TBYZFBL0018 |         |                                |             |  |               |         |
|                 |                     |               |   | Neon Yellow     |     | R-TBYZFGF0018 |         |                                |             |  |               |         |
|                 |                     |               |   | Black           |     | R-TBYZFNR0018 |         |                                |             |  |               |         |
|                 |                     |               |   | Quantum Grey    |     | R-TBYZFGR0018 |         |                                |             |  |               |         |
|                 |                     |               |   | White           |     | R-TBYZFBN0010 |         | € 28,95                        |             |  |               |         |
|                 |                     |               |   | YZ Blue         |     | R-TBYZFBL0010 |         |                                |             |  |               |         |
|                 |                     |               |   | Black           |     | R-TBYZFNR0010 |         |                                |             |  |               |         |
|                 |                     |               |   | Neon Yellow     |     | R-TBYZFGF0010 |         |                                |             |  |               |         |
|                 |                     |               |   | Y Yellow        |     | R-TBYZFGY0010 |         |                                |             |  |               |         |
| CR Red          |                     | R-TBYZFRS0010 |   |                 |     |               |         |                                |             |  |               |         |
| Quantum Grey    |                     | R-TBYZFGR0010 |   |                 |     |               |         |                                |             |  |               |         |
| Ducati Neon Red |                     | R-TBYZFRD0010 |   |                 |     |               |         |                                |             |  |               |         |
| Limited Edition |                     |               |   |                 |     |               |         |                                |             |  |               |         |
| Limited Edition |                     |               |   |                 |     |               |         |                                |             |  |               |         |
| YZ-X            | 125                 | 2020 > 2022   | OEM 2020<br>OEM 2021 > 2022                               | White           |     | R-TBYZFBN0010 | € 28,95 |                                |             |  |               |         |
|                 |                     |               |   | YZ Blue         |     | R-TBYZFBL0010 |         |                                |             |  |               |         |
|                 |                     |               |   | Black           |     | R-TBYZFNR0010 |         |                                |             |  |               |         |
|                 |                     |               |   | Neon Yellow     |     | R-TBYZFGF0010 |         |                                |             |  |               |         |
|                 |                     |               |   | Y Yellow        |     | R-TBYZFGY0010 |         |                                |             |  |               |         |
|                 |                     |               |   | CR Red          |     | R-TBYZFRS0010 |         |                                |             |  |               |         |
|                 |                     |               |   | Quantum Grey    |     | R-TBYZFGR0010 |         |                                |             |  |               |         |
|                 |                     |               |   | Ducati Neon Red |     | R-TBYZFRD0010 |         |                                |             |  |               |         |
|                 |                     |               |   | Limited Edition |     |               |         |                                |             |  |               |         |
|                 |                     |               |   | Limited Edition |     |               |         |                                |             |  |               |         |
| YZ-X            | 125-250             | 2023          | OEM   | White           |     | R-TBYZFBN0018 | € 28,95 |                                |             |  |               |         |
|                 |                     |               |   | YZ Blue         |     | R-TBYZFBL0018 |         |                                |             |  |               |         |
|                 |                     |               |   | Neon Yellow     |     | R-TBYZFGF0018 |         |                                |             |  |               |         |
|                 |                     |               |   | Black           |     | R-TBYZFNR0018 |         |                                |             |  |               |         |
| YZ / YZF        | 125-250-400-426-450 | 2000 > 2005   | Fits the TBYZF__0010 front plate on<br>models 2002 > 2005 | Quantum Grey    |     | R-TBYZFGR0018 | € 18,95 |                                |             |  |               |         |
|                 |                     |               |   | Red             |     | R-SUPTABYZ915 |         |                                |             |  |               |         |
|                 |                     |               |   | White           |     | R-TBYZFBN9603 |         | € 28,95                        |             |  |               |         |
|                 |                     |               |   | Black           |     | R-TBYZFNR9603 |         |                                |             |  |               |         |
| YZF             | 250-426-450         | 2000 > 2005   | OEM   | White           |     | R-TBYZ0BN0006 | € 28,95 |                                |             |  |               |         |
|                 |                     |               |   | YZ Blue         |     | R-TBYZ0BL0006 |         |                                |             |  |               |         |
|                 |                     |               |   | Black           |     | R-TBYZ0NR0006 |         |                                |             |  |               |         |
|                 |                     |               |   | White           |     | R-TBYZFBN0010 |         | € 28,95                        |             |  |               |         |
| YZ Blue         |                     | R-TBYZFBL0010 |   |                 |     |               |         |                                |             |  |               |         |
| Black           |                     | R-TBYZFNR0010 |   |                 |     |               |         |                                |             |  |               |         |
| Neon Yellow     |                     | R-TBYZFGF0010 |   |                 |     |               |         |                                |             |  |               |         |
| YZF             | 250                 | 2010 > 2018   | OEM   | Y Yellow        |     | R-TBYZFGY0010 | € 28,95 |                                |             |  |               |         |
|                 |                     |               |   | CR Red          |     | R-TBYZFRS0010 |         |                                |             |  |               |         |
|                 |                     |               |   | Quantum Grey    |     | R-TBYZFGR0010 |         |                                |             |  |               |         |
|                 |                     |               |   | Ducati Neon Red |     | R-TBYZFRD0010 |         |                                |             |  |               |         |
|                 |                     |               |   | Limited Edition |     |               |         |                                |             |  |               |         |
|                 |                     |               |   | Limited Edition |     |               |         |                                |             |  |               |         |
|                 |                     |               |   | YZF             | 250 | 2019 > 2023   |         | OEM 2019-2020<br>OEM 2021-2022 | White       |  | R-TBYZFBN0018 | € 28,95 |
|                 |                     |               |   |                 |     |               |         |                                | YZ Blue     |  | R-TBYZFBL0018 |         |
|                 |                     |               |   |                 |     |               |         |                                | Neon Yellow |  | R-TBYZFGF0018 |         |
|                 |                     |               |   |                 |     |               |         |                                | Black       |  | R-TBYZFNR0018 |         |
| Quantum Grey    |                     | R-TBYZFGR0018 |   |                 |     |               |         |                                |             |  |               |         |
| Limited Edition |                     |               |   |                 |     |               |         |                                |             |  |               |         |

**NEW**

# YAMAHA FRONT NUMBER PLATE / TABELLA PORTANUMERO ANTERIORE

OEM original color - ☀️ fluorescent color

| MODEL           | CC  | YEAR          | NOTES | COLOR           | CODE | PRICE         |                                  |                             |         |               |               |         |
|-----------------|-----|---------------|-------|-----------------|------|---------------|----------------------------------|-----------------------------|---------|---------------|---------------|---------|
| YZF             | 450 | 2010 > 2017   | OEM   | White           |      | R-TBYZFBN0010 | € 28,95                          |                             |         |               |               |         |
|                 |     |               |       | YZ Blue         |      | R-TBYZFBL0010 |                                  |                             |         |               |               |         |
|                 |     |               |       | Black           |      | R-TBYZFN0010  |                                  |                             |         |               |               |         |
|                 |     |               |       | Neon Yellow     |      | R-TBYZFGF0010 |                                  |                             |         |               |               |         |
|                 |     |               |       | Y Yellow        |      | R-TBYZFGY0010 |                                  |                             |         |               |               |         |
|                 |     |               |       | CR Red          |      | R-TBYZFRS0010 |                                  |                             |         |               |               |         |
|                 |     |               |       | Limited Edition |      | R-TBYZFG0010  |                                  |                             |         |               |               |         |
|                 |     |               |       | Limited Edition |      | R-TBYZFRD0010 |                                  |                             |         |               |               |         |
|                 |     |               |       | YZF             | 450  | 2018 > 2022   |                                  | OEM 2018 > 2020<br>OEM 2021 | White   |               | R-TBYZFBN0018 | € 28,95 |
|                 |     |               |       |                 |      |               |                                  |                             | YZ Blue |               | R-TBYZFBL0018 |         |
| Neon Yellow     |     | R-TBYZFGF0018 |       |                 |      |               |                                  |                             |         |               |               |         |
| Black           |     | R-TBYZFN0018  |       |                 |      |               |                                  |                             |         |               |               |         |
| Limited Edition |     | R-TBYZFG0018  |       |                 |      |               |                                  |                             |         |               |               |         |
| YZF             | 450 | 2023          | OEM   |                 |      |               | YZ Blue                          |                             |         | R-TBYZFBL0023 | € 28,95       |         |
|                 |     |               |       |                 |      |               | White                            |                             |         | R-TBYZFBN0023 |               |         |
|                 |     |               |       |                 |      |               | Black                            |                             |         | R-TBYZFN0023  |               |         |
|                 |     |               |       |                 |      |               | Limited Edition                  |                             |         | R-TBYZFG0023  |               |         |
|                 |     |               |       |                 |      |               | YZ-X                             |                             | 250     | 2016 > 2022   |               |         |
|                 |     |               |       | YZ Blue         |      | R-TBYZFBL0010 |                                  |                             |         |               |               |         |
|                 |     |               |       | Black           |      | R-TBYZFN0010  |                                  |                             |         |               |               |         |
|                 |     |               |       | Neon Yellow     |      | R-TBYZFGF0010 |                                  |                             |         |               |               |         |
|                 |     |               |       | Y Yellow        |      | R-TBYZFGY0010 |                                  |                             |         |               |               |         |
|                 |     |               |       | CR Red          |      | R-TBYZFRS0010 |                                  |                             |         |               |               |         |
| Limited Edition |     | R-TBYZFG0010  |       |                 |      |               |                                  |                             |         |               |               |         |
| Limited Edition |     | R-TBYZFRD0010 |       |                 |      |               |                                  |                             |         |               |               |         |
| YZ-FX           | 250 | 2015 > 2019   | OEM   | White           |      | R-TBYZFBN0010 |                                  | € 28,95                     |         |               |               |         |
|                 |     |               |       | YZ Blue         |      | R-TBYZFBL0010 |                                  |                             |         |               |               |         |
|                 |     |               |       | Black           |      | R-TBYZFN0010  |                                  |                             |         |               |               |         |
|                 |     |               |       | Neon Yellow     |      | R-TBYZFGF0010 |                                  |                             |         |               |               |         |
|                 |     |               |       | Y Yellow        |      | R-TBYZFGY0010 |                                  |                             |         |               |               |         |
|                 |     |               |       | CR Red          |      | R-TBYZFRS0010 |                                  |                             |         |               |               |         |
|                 |     |               |       | Limited Edition |      | R-TBYZFG0010  |                                  |                             |         |               |               |         |
|                 |     |               |       | Limited Edition |      | R-TBYZFRD0010 |                                  |                             |         |               |               |         |
|                 |     |               |       | YZ-FX           | 250  | 2020 > 2023   | OEM 2020<br>OEM 2021 > 2023      |                             | White   |               | R-TBYZFBN0018 | € 28,95 |
|                 |     |               |       |                 |      |               |                                  |                             | YZ Blue |               | R-TBYZFBL0018 |         |
| Neon Yellow     |     | R-TBYZFGF0018 |       |                 |      |               |                                  |                             |         |               |               |         |
| Black           |     | R-TBYZFN0018  |       |                 |      |               |                                  |                             |         |               |               |         |
| Limited Edition |     | R-TBYZFG0018  |       |                 |      |               |                                  |                             |         |               |               |         |
| YZ-FX           | 450 | 2016 > 2018   | OEM   |                 |      |               |                                  | White                       |         | R-TBYZFBN0010 | € 28,95       |         |
|                 |     |               |       |                 |      |               |                                  | YZ Blue                     |         | R-TBYZFBL0010 |               |         |
|                 |     |               |       |                 |      |               |                                  | Black                       |         | R-TBYZFN0010  |               |         |
|                 |     |               |       |                 |      |               |                                  | Neon Yellow                 |         | R-TBYZFGF0010 |               |         |
|                 |     |               |       |                 |      |               |                                  | Y Yellow                    |         | R-TBYZFGY0010 |               |         |
|                 |     |               |       | CR Red          |      | R-TBYZFRS0010 |                                  |                             |         |               |               |         |
|                 |     |               |       | Limited Edition |      | R-TBYZFG0010  |                                  |                             |         |               |               |         |
|                 |     |               |       | Limited Edition |      | R-TBYZFRD0010 |                                  |                             |         |               |               |         |
|                 |     |               |       | YZ-FX           | 450  | 2019 > 2023   | OEM 2019-2020<br>OEM 2021 > 2023 | White                       |         | R-TBYZFBN0018 |               | € 28,95 |
|                 |     |               |       |                 |      |               |                                  | YZ Blue                     |         | R-TBYZFBL0018 |               |         |
| Black           |     | R-TBYZFN0018  |       |                 |      |               |                                  |                             |         |               |               |         |
| Neon Yellow     |     | R-TBYZFGF0018 |       |                 |      |               |                                  |                             |         |               |               |         |
| Limited Edition |     | R-TBYZFG0018  |       |                 |      |               |                                  |                             |         |               |               |         |

**NEW**

# YAMAHA FACTORY FRONT NUMBER PLATE / TABELLA PORTANUMERO ANTERIORE

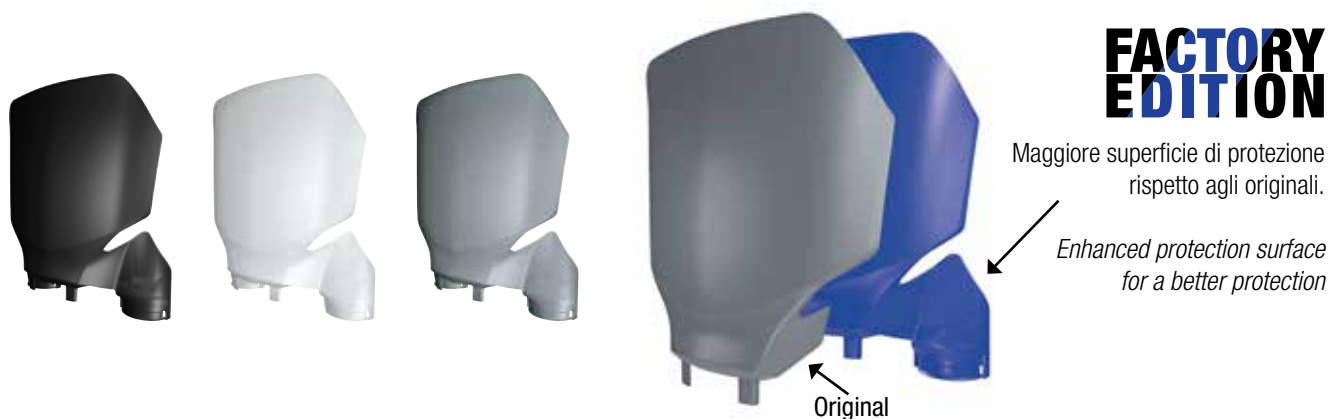

| MODEL | CC  | YEAR | NOTES | COLOR           | CODE | PRICE         |         |
|-------|-----|------|-------|-----------------|------|---------------|---------|
| YZF   | 450 | 2023 | OEM   | YZ Blue         |      | R-TBYZFBL0093 | € 38,95 |
|       |     |      |       | White           |      | R-TBYZFBN0093 |         |
|       |     |      |       | Black           |      | R-TBYZFN0093  |         |
|       |     |      |       | Limited Edition |      | R-TBYZFG0093  |         |

**FACTORY EDITION**

# YAMAHA FORK PROTECTORS / PARASTELI FORCELLA



**NEON**



R-PSWRFBN0019



R-PSYZ0GF0010



R-PSYZORS0010



R-PSYZ0BL0010





R-PSYZONR0010

**OEM** original color - fluorescent color

| MODEL        | CC            | YEAR        | NOTES  | COLOR        | CODE          | PRICE   |             |                 |         |               |         |
|--------------|---------------|-------------|--|--------------|---------------|---------|-------------|-----------------|---------|---------------|---------|
| YZ           | 65            | 2018 > 2023 | OEM 2018 > 2020<br>OEM 2021-2022<br>OEM 2023 | White        | R-PSYZ0BN0065 | € 28,95 |             |                 |         |               |         |
|              |               |             |  | Black        | R-PSYZONR0065 |         |             |                 |         |               |         |
|              |               |             |  | Deep Blue    | R-PSYZ0DB0065 |         |             |                 |         |               |         |
| YZ           | 85            | 2002 > 2018 | OEM  | White        | R-PSYZ0BN0085 | € 28,95 |             |                 |         |               |         |
| YZ           | 85            | 2019 > 2023 | OEM 2019-2020<br>OEM 2021-2022<br>OEM 2023   | White        | R-PSYZ0BN0185 | € 28,95 |             |                 |         |               |         |
|              |               |             |  | Black        | R-PSYZONR0185 |         |             |                 |         |               |         |
|              |               |             |  | Deep Blue    | R-PSYZ0DB0185 |         |             |                 |         |               |         |
|              |               |             |  | White        | R-PSYZ0BN0003 |         | € 34,95     |                 |         |               |         |
| Black        | R-PSYZONR0003 |             |  |              |               |         |             |                 |         |               |         |
| YZ / WR      | 125-250       | 1998 > 2004 | OEM  | White        | R-PSYZ0BN0005 | € 34,95 |             |                 |         |               |         |
| YZ           | 125-250       | 2005 > 2007 | OEM  | YZ Blue      | R-PSYZ0BL0005 |         |             |                 |         |               |         |
| YZ           | 125-250       | 2008 > 2014 | OEM  | Black        | R-PSYZONR0005 | € 34,95 |             |                 |         |               |         |
|              |               |             |  | White        | R-PSYZ0BN0008 |         |             |                 |         |               |         |
|              |               |             |  | YZ Blue      | R-PSYZ0BL0008 |         |             |                 |         |               |         |
| YZ           | 125-250       | 2015 > 2023 | OEM 2015 > 2020<br>OEM 2021-2022             | Black        | R-PSYZONR0008 | € 34,95 |             |                 |         |               |         |
|              |               |             |  | White        | R-PSYZ0BN0010 |         |             |                 |         |               |         |
|              |               |             |  | YZ Blue      | R-PSYZ0BL0010 |         |             |                 |         |               |         |
|              |               |             |  | Black        | R-PSYZONR0010 |         |             |                 |         |               |         |
|              |               |             |  | Neon Yellow  | R-PSYZ0GF0010 |         |             |                 |         |               |         |
|              |               |             |  | CR Red       | R-PSYZORS0010 |         |             |                 |         |               |         |
|              |               |             |  | Quantum Grey | R-PSYZ0GR0010 |         |             |                 |         |               |         |
| YZ-X         | 125           | 2020 > 2023 | OEM 2023<br>OEM 2020<br>OEM 2021-2022        | Deep Blue    | R-PSYZ0DB0010 | € 34,95 |             |                 |         |               |         |
|              |               |             |  | White        | R-PSYZ0BN0010 |         |             |                 |         |               |         |
|              |               |             |  | Black        | R-PSYZONR0010 |         |             |                 |         |               |         |
|              |               |             |  | YZ Blue      | R-PSYZ0BL0010 |         |             |                 |         |               |         |
|              |               |             |  | Neon Yellow  | R-PSYZ0GF0010 |         |             |                 |         |               |         |
|              |               |             |  | CR Red       | R-PSYZORS0010 |         |             |                 |         |               |         |
|              |               |             |  | Quantum Grey | R-PSYZ0GR0010 |         |             |                 |         |               |         |
|              |               |             |  | Deep Blue    | R-PSYZ0DB0010 |         | € 34,95     |                 |         |               |         |
|              |               |             |  | White        | R-PSYZ0BN0003 |         |             |                 |         |               |         |
|              |               |             |  | YZF          | 250           |         | 2001 > 2004 | OEM 2023<br>OEM | Black   | R-PSYZONR0003 | € 34,95 |
| White        | R-PSYZ0BN0005 |             |  |              |               |         |             |                 |         |               |         |
| YZ Blue      | R-PSYZ0BL0005 |             |  |              |               |         |             |                 |         |               |         |
| YZF          | 250-450       | 2005 > 2007 | OEM  | Black        | R-PSYZONR0005 | € 34,95 |             |                 |         |               |         |
|              |               |             |  | White        | R-PSYZ0BN0008 |         |             |                 |         |               |         |
|              |               |             |  | YZ Blue      | R-PSYZ0BL0008 |         |             |                 |         |               |         |
| YZF          | 250-450       | 2008-2009   | OEM  | Black        | R-PSYZONR0008 | € 34,95 |             |                 |         |               |         |
|              |               |             |  | White        | R-PSYZ0BN0010 |         |             |                 |         |               |         |
|              |               |             |  | YZ Blue      | R-PSYZ0BL0010 |         |             |                 |         |               |         |
| YZF          | 250           | 2010 > 2023 | OEM 2010 > 2020<br>OEM 2021-2022             | Black        | R-PSYZONR0010 | € 34,95 |             |                 |         |               |         |
|              |               |             |  | White        | R-PSYZ0BN0010 |         |             |                 |         |               |         |
|              |               |             |  | YZ Blue      | R-PSYZ0BL0010 |         |             |                 |         |               |         |
|              |               |             |  | Neon Yellow  | R-PSYZ0GF0010 |         |             |                 |         |               |         |
|              |               |             |  | CR Red       | R-PSYZORS0010 |         |             |                 |         |               |         |
|              |               |             |  | Quantum Grey | R-PSYZ0GR0010 |         |             |                 |         |               |         |
|              |               |             |  | Deep Blue    | R-PSYZ0DB0010 |         |             |                 |         |               |         |
| YZF          | 450           | 2010 > 2022 | OEM 2023<br>OEM 2010 > 2020<br>OEM 2021      | White        | R-PSYZ0BN0010 | € 34,95 |             |                 |         |               |         |
|              |               |             |  | Black        | R-PSYZONR0010 |         |             |                 |         |               |         |
|              |               |             |  | YZ Blue      | R-PSYZ0BL0010 |         |             |                 |         |               |         |
|              |               |             |  | Neon Yellow  | R-PSYZ0GF0010 |         |             |                 |         |               |         |
|              |               |             |  | CR Red       | R-PSYZORS0010 |         |             |                 |         |               |         |
|              |               |             |  | Quantum Grey | R-PSYZ0GR0010 |         |             |                 |         |               |         |
|              |               |             |  | Deep Blue    | R-PSYZ0DB0010 |         | € 34,95     |                 |         |               |         |
|              |               |             |  | White        | R-PSYZ0BN0023 |         |             |                 |         |               |         |
|              |               |             |  | YZF          | 450           |         | 2023        | OEM 2023        | Black   | R-PSYZONR0023 | € 34,95 |
|              |               |             |  |              |               |         |             |                 | YZ Blue | R-PSYZ0BL0023 |         |
| White        | R-PSYZ0BN0023 |             |  |              |               |         |             |                 |         |               |         |
| Quantum Grey | R-PSYZ0GR0023 |             |  |              |               |         |             |                 |         |               |         |
| White        | R-PSYZ0BN0003 | € 34,95     |  |              |               |         |             |                 |         |               |         |
| Black        | R-PSYZONR0003 |             |  |              |               |         |             |                 |         |               |         |
| YZF          | 450           | 2003-2004   | OEM  | White        | R-PSYZ0BN0003 | € 34,95 |             |                 |         |               |         |
| Black        | R-PSYZONR0003 |             |  |              |               |         |             |                 |         |               |         |

**NEW**

**OEM** original color -  fluorescent color

| MODEL | CC      | YEAR        | NOTES  | COLOR   | CODE          | PRICE       |  |  |               |               |         |
|-------|---------|-------------|--|---|---------------|-------------|--|--|---------------|---------------|---------|
| YZ-FX | 250-450 | 2015 > 2023 | OEM 2015 > 2020<br>OEM 2021 > 2023   | White   | R-PSYZ0BN0010 | € 34,95     |  |  |               |               |         |
|       |         |             |  | Black   | R-PSYZ0NR0010 |             |  |  |               |               |         |
|       |         |             |  | YZ Blue   | R-PSYZ0BL0010 |             |  |  |               |               |         |
|       |         |             |  | Neon Yellow  | R-PSYZ0GF0010 |             |  |  |               |               |         |
|       |         |             |  | CR Red  | R-PSYZ0RS0010 |             |  |  |               |               |         |
|       |         |             |  | Quantum Grey  | R-PSYZ0GR0010 |             |  |  |               |               |         |
| YZ-X  | 250     | 2016 > 2023 | OEM 2023<br>OEM 2016 > 2020<br>OEM 2021 > 2023   | Deep Blue   | R-PSYZ0DB0010 | € 34,95     |  |  |               |               |         |
|       |         |             |  | White   | R-PSYZ0BN0010 |             |  |  |               |               |         |
|       |         |             |  | Black   | R-PSYZ0NR0010 |             |  |  |               |               |         |
|       |         |             |  | YZ Blue   | R-PSYZ0BL0010 |             |  |  |               |               |         |
|       |         |             |  | Neon Yellow  | R-PSYZ0GF0010 |             |  |  |               |               |         |
|       |         |             |  | CR Red  | R-PSYZ0RS0010 |             |  |  |               |               |         |
| WRF   | 250-450 | 2001 > 2004 | OEM 2023<br>OEM - Without tachimeter cable guide<br>Without tachimeter cable guide                       | Deep Blue   | R-PSYZ0DB0010 | € 34,95     |  |  |               |               |         |
|       |         |             |  | White   | R-PSYZ0BN0003 |             |  |  |               |               |         |
|       |         |             |  | Black   | R-PSYZ0NR0003 |             |  |  |               |               |         |
|       |         |             |  | WRF   | 450           |             | 2005 > 2018  | OEM - Without tachimeter cable guide<br>Without tachimeter cable guide | White         | R-PSYZ0BN0005 | € 34,95 |
|       |         |             |  |   |               |             |  |  | YZ Blue       | R-PSYZ0BL0005 |         |
|       |         |             |  |   |               |             |  |  | Black         | R-PSYZ0NR0005 |         |
| WRF   | 250     | 2005 > 2019 | OEM - Without tachimeter cable guide<br>Without tachimeter cable guide<br>Without tachimeter cable guide |   |               | White       |  |  | R-PSYZ0BN0005 | € 34,95       |         |
|       |         |             |  |   |               | YZ Blue     |  |  | R-PSYZ0BL0005 |               |         |
|       |         |             |  |   |               | Black       |  |  | R-PSYZ0NR0005 |               |         |
|       |         |             |  | WRF   | 250           | 2020 > 2022 | OEM 2020 - With tachimeter cable guide<br>With tachimeter cable guide<br>OEM 2021>2023 - With tachimeter cable guide | White  | R-PSWRFBN0019 |               | € 34,95 |
|       |         |             |  |   |               |             |  | YZ Blue  | R-PSWRFBL0019 |               |         |
|       |         |             |  |   |               |             |  | Black  | R-PSWRFNR0019 |               |         |
| WRF   | 400-426 | 1998 > 2002 | OEM - Without tachimeter cable guide<br>Without tachimeter cable guide                                   |   |               |             |  | White  | R-PSYZ0BN0003 | € 34,95       |         |
|       |         |             |  |   |               |             |  | Black  | R-PSYZ0NR0003 |               |         |
|       |         |             |  |   |               |             |  | WRF  | 450           |               |         |
|       |         |             |  | YZ Blue   | R-PSWRFBL0019 |             |  |  |               |               |         |
|       |         |             |  | Black   | R-PSWRFNR0019 |             |  |  |               |               |         |



## YAMAHA REAR SHOCK MUD FLAP / PARASPRUZZI MONOAMMORTIZZATORE

### AVAILABLE COLORS

-  YZ Blue
-  Black

R-PSPYZ0BL010



R-PSPYZ0NR010



**OEM**

 fluorescent color

**OEM** original color

| MODEL          | CC              | YEAR        | NOTES | COLOR   | CODE          | PRICE   |
|----------------|-----------------|-------------|-------|---------|---------------|---------|
| YZ             | 65              | 2018 > 2023 | OEM   | Black   | R-PSPYZ0NR010 | € 18,95 |
|                |                 |             |       | YZ Blue | R-PSPYZ0BL010 |         |
| YZ             | 85              | 2002 > 2021 | OEM   | Black   | R-PSPYZ0NR000 | € 18,95 |
|                |                 |             |       | YZ Blue | R-PSPYZ0BL000 |         |
| YZ             | 85              | 2022-2023   | OEM   | Black   | R-PSPYZ0NR085 | € 18,95 |
|                |                 |             |       | YZ Blue | R-PSPYZ0BL085 |         |
| YZ / YZ-X / WR | 125-250         | 1996 > 2023 | OEM   | Black   | R-PSPYZ0NR000 | € 18,95 |
|                |                 |             |       | YZ Blue | R-PSPYZ0BL000 |         |
| YZF            | 250-400-426-450 | 1998 > 2009 | OEM   | Black   | R-PSPYZ0NR000 | € 18,95 |
|                |                 |             |       | YZ Blue | R-PSPYZ0BL000 |         |
| YZF            | 250             | 2010 > 2018 | OEM   | Black   | R-PSPYZ0NR010 | € 18,95 |
|                |                 |             |       | YZ Blue | R-PSPYZ0BL010 |         |
| YZF            | 250             | 2019 > 2023 | OEM   | Black   | R-PSPYZ0NR000 | € 18,95 |
|                |                 |             |       | YZ Blue | R-PSPYZ0BL000 |         |
| YZ-FX          | 250             | 2015 > 2019 | OEM   | Black   | R-PSPYZ0NR010 | € 18,95 |
|                |                 |             |       | YZ Blue | R-PSPYZ0BL010 |         |
| YZ-FX          | 250             | 2020 > 2023 | OEM   | Black   | R-PSPYZ0NR000 | € 18,95 |
|                |                 |             |       | YZ Blue | R-PSPYZ0BL000 |         |
| YZF            | 450             | 2010 > 2013 | OEM   | Black   | R-PSPYZ0NR011 | € 18,95 |
|                |                 |             |       | YZ Blue | R-PSPYZ0BL011 |         |
| YZF            | 450             | 2014 > 2017 | OEM   | Black   | R-PSPYZ0NR010 | € 18,95 |
|                |                 |             |       | YZ Blue | R-PSPYZ0BL010 |         |
| YZF            | 450             | 2018 > 2023 | OEM   | Black   | R-PSPYZ0NR000 | € 18,95 |
|                |                 |             |       | YZ Blue | R-PSPYZ0BL000 |         |
| YZ-FX          | 450             | 2016 > 2018 | OEM   | Black   | R-PSPYZ0NR010 | € 18,95 |
|                |                 |             |       | YZ Blue | R-PSPYZ0BL010 |         |
| YZ-FX          | 450             | 2019 > 2023 | OEM   | Black   | R-PSPYZ0NR000 | € 18,95 |
|                |                 |             |       | YZ Blue | R-PSPYZ0BL000 |         |
| WRF            | 250-400-426-450 | 1998 > 2023 | OEM   | Black   | R-PSPYZ0NR000 | € 18,95 |
|                |                 |             |       | YZ Blue | R-PSPYZ0BL000 |         |

# YAMAHA CHAIN GUIDE / CRUNA GUIDA CATENA



R-CRUYZBL0007



R-CRUYZNR0007



R-CRUYZRS0007

## AVAILABLE COLORS

YZ Blue Black CR Red

**OEM** original color

| MODEL          | CC              | YEAR            | NOTES | COLOR   | CODE          | PRICE   |
|----------------|-----------------|-----------------|-------|---------|---------------|---------|
| YZ             | 65              | 2018 > 2023     | OEM   | Black   | R-CRUYZNR0085 | € 25,95 |
| YZ             | 85              | 2021 > 2023     | OEM   | Black   | R-CRUYZNR0085 | € 25,95 |
| YZ / WR        | 125-250         | 1997 > 2004     | OEM   | Black   | R-CRUYZNR0003 | € 25,95 |
|                |                 |                 |       | YZ Blue | R-CRUYZBL0003 |         |
| YZ / YZF / WRF | 125-250-450     | 2005-2006       | OEM   | Black   | R-CRUYZNR0005 | € 25,95 |
|                |                 |                 |       | YZ Blue | R-CRUYZBL0005 |         |
| YZ / YZ-X      | 125-250-450     | 2007 > 2023     | OEM   | Black   | R-CRUYZNR0007 | € 25,95 |
|                |                 |                 |       | YZ Blue | R-CRUYZBL0007 |         |
|                |                 |                 |       | CR Red  | R-CRUYZRS0007 |         |
| YZF / WRF      | 250-400-426-450 | 1997 > 2004     | OEM   | Black   | R-CRUYZNR0003 | € 25,95 |
|                |                 |                 |       | YZ Blue | R-CRUYZBL0003 |         |
| YZF            | 250             | 2007 > 2023     | OEM   | Black   | R-CRUYZNR0007 | € 25,95 |
|                |                 |                 |       | YZ Blue | R-CRUYZBL0007 |         |
|                |                 |                 |       | CR Red  | R-CRUYZRS0007 |         |
| YZF            | 450             | 2007 > 2022     | OEM   | Black   | R-CRUYZNR0007 | € 25,95 |
|                |                 |                 |       | YZ Blue | R-CRUYZBL0007 |         |
|                |                 |                 |       | CR Red  | R-CRUYZRS0007 |         |
| YZF            | 450             | <b>NEW</b> 2023 | OEM   | Black   | R-CRUYZNR0023 | € 25,95 |
|                |                 |                 |       | YZ Blue | R-CRUYZBL0023 |         |
| YZ-X           | 250             | 2007 > 2023     | OEM   | Black   | R-CRUYZNR0007 | € 25,95 |
|                |                 |                 |       | YZ Blue | R-CRUYZBL0007 |         |
|                |                 |                 |       | CR Red  | R-CRUYZRS0007 |         |
| YZ-FX / WRF    | 250-450         | 2007 > 2023     | OEM   | Black   | R-CRUYZNR0007 | € 25,95 |
|                |                 |                 |       | YZ Blue | R-CRUYZBL0007 |         |
|                |                 |                 |       | CR Red  | R-CRUYZRS0007 |         |



# YAMAHA CHAIN SLIDER / SLITTA SCORRICATENA FORCELLONE



R-SLIYZNR0009



R-SLIYZBL0003

## AVAILABLE COLORS

YZ Blue

Black

**OEM** original color

| MODEL     | CC              | YEAR        | NOTES | COLOR      | CODE          | PRICE   |
|-----------|-----------------|-------------|-------|------------|---------------|---------|
| YZ        | 85              | 2022 > 2023 | OEM   | Black      | R-SLIYZNR0085 | € 25,95 |
| YZ / WR   | 125-250         | 1997 > 2004 | OEM   | Black      | R-SLIYZNR0003 | € 25,95 |
|           |                 |             |       | YZ YZ Blue | R-SLIYZBL0003 |         |
| YZ/YZ-X   | 125-250-450     | 2005 > 2023 | OEM   | Black      | R-SLIYZNR0005 | € 25,95 |
|           |                 |             |       | YZ YZ Blue | R-SLIYZBL0005 |         |
| YZF / WRF | 250-400-426-450 | 1998 > 2004 | OEM   | Black      | R-SLIYZNR0003 | € 25,95 |
|           |                 |             |       | YZ YZ Blue | R-SLIYZBL0003 |         |
| YZF       | 250-450         | 2005 > 2008 | OEM   | Black      | R-SLIYZNR0005 | € 25,95 |
|           |                 |             |       | YZ YZ Blue | R-SLIYZBL0005 |         |
| YZF       | 250-450         | 2009 > 2023 | OEM   | Black      | R-SLIYZNR0009 | € 25,95 |
|           |                 |             |       | YZ YZ Blue | R-SLIYZBL0009 |         |
| YZ-FX     | 250             | 2015 > 2023 | OEM   | Black      | R-SLIYZNR0009 | € 25,95 |
|           |                 |             |       | YZ Blue    | R-SLIYZBL0009 |         |
| YZ-FX     | 450             | 2016 > 2023 | OEM   | Black      | R-SLIYZNR0009 | € 25,95 |
|           |                 |             |       | YZ Blue    | R-SLIYZBL0009 |         |
| WRF       | 250             | 2005 > 2019 | OEM   | Black      | R-SLIYZNR0005 | € 25,95 |
|           |                 |             |       | YZ Blue    | R-SLIYZBL0005 |         |
| WRF       | 250             | 2020 > 2023 | OEM   | Black      | R-SLIYZNR0009 | € 25,95 |
|           |                 |             |       | YZ Blue    | R-SLIYZBL0009 |         |
| WRF       | 450             | 2005 > 2018 | OEM   | Black      | R-SLIYZNR0005 | € 25,95 |
|           |                 |             |       | YZ Blue    | R-SLIYZBL0005 |         |
| WRF       | 450             | 2019 > 2023 | OEM   | Black      | R-SLIYZNR0009 | € 25,95 |
|           |                 |             |       | YZ Blue    | R-SLIYZBL0009 |         |

UPGRADE YOUR YZ 125-250 2002 > 2014 2 STROKE  
 AGGIORNA LA TUA YZ 125-250 2002 > 2014 2 TEMPI

# TO > 2021 VERSION

BEFORE / PRIMA



model year 2002 > 2004\*

AFTER / DOPO



BEFORE / PRIMA



model year 2005 > 2014\*

AFTER / DOPO



\* To fit the front number plate style 2015 > 2021 on model year 2002 > 2005 require the code R-SUPTABYZ915 (not included)  
 \* per montare la tabella portanumero anteriore 2015 > 2021 sui modelli 2002 > 2005 è necessario il codice R-SUPTABYZ915 (non incluso)



OEM - cod. R-KITYZO-OEM-000

price €154,95



OEM - cod. R-KITYZO-BLO-000

price €154,95



White - cod. R-KITYZO-BNO-000

price €154,95



Black - cod. R-KITYZO-NR0-000

price €154,95



R-SUPTABYZ915

price €18,95

# YAMAHA REPLICAS PLASTICS KIT / KIT PLASTICHE REPLICA



R-KITYZF-OEM-518

**OEM** original color - ☀️ fluorescent color

| MODEL     | CC          | YEAR        | NOTES   | COLOR         |  |  |  |  |  |                  | CODE             | PRICE    |
|-----------|-------------|-------------|---|---------------|--|--|--|--|--|------------------|------------------|----------|
| YZ        | 65          | 2018 > 2023 | OEM 2018 > 2020<br>OEM 2021 > 2023                                      | OEM           |  |  |  |  |  |                  | R-KITYZO-OEM-565 | € 134,95 |
|           |             |             |   | OEM           |  |  |  |  |  |                  | R-KITYZO-BLO-565 |          |
| YZ        | 85          | 2002 > 2014 | OEM 2013-2014   | OEM           |  |  |  |  |  |                  | R-KITYZO-OEM-509 | € 134,95 |
|           |             |             |   | OEM           |  |  |  |  |  |                  | R-KITYZO-OEM-585 | € 134,95 |
| YZ        | 85          | 2015 > 2021 | OEM 2015 > 2020<br>OEM 2021   | OEM           |  |  |  |  |  |                  | R-KITYZO-BLO-585 | € 134,95 |
|           |             |             |   | OEM           |  |  |  |  |  |                  | R-KITYZO-BLO-085 |          |
| YZ        | 85          | 2022-2023   | OEM   | OEM           |  |  |  |  |  |                  | R-KITYZO-BNO-085 | € 134,95 |
|           |             |             |   | White         |  |  |  |  |  | R-KITYZO-NR0-085 |                  |          |
|           |             |             |   | Black         |  |  |  |  |  | R-KITYZO-NR0-085 |                  |          |
| YZ        | 125-250     | 1996 > 2001 | OEM 2013-2014   | OEM           |  |  |  |  |  |                  | R-KITYZO-OEM-501 | € 134,95 |
|           |             |             |   | OEM           |  |  |  |  |  |                  | R-KITYZO-OEM-502 | € 134,95 |
| YZ        | 125-250     | 2002 > 2005 | OEM 2002>2020   | OEM           |  |  |  |  |  |                  | R-KITYZO-BNO-502 | € 154,95 |
|           |             |             |   | White         |  |  |  |  |  | R-KITYZO-NR0-502 |                  |          |
| YZ / YZ-X | 125-250     | 2002 > 2021 | OEM 2002>2020<br>For models 02-05 the code R-SUPTABYZ015 is requiCR Red | OEM           |  |  |  |  |  |                  | R-KITYZO-OEM-000 | € 134,95 |
|           |             |             |   | Black         |  |  |  |  |  | R-KITYZO-NR0-000 |                  |          |
| YZ        | 125-250     | 2006 > 2014 | OEM 2021<br>OEM 2013-2014   | OEM           |  |  |  |  |  |                  | R-KITYZO-BNO-000 | € 134,95 |
|           |             |             |   | White-Black   |  |  |  |  |  | R-KITYZO-BLO-000 |                  |          |
| YZ        | 125-250     | 2006 > 2014 | OEM 2013-2014   | OEM           |  |  |  |  |  |                  | R-KITYZO-OEM-504 | € 134,95 |
|           |             |             |   | White         |  |  |  |  |  | R-KITYZO-BNO-504 |                  |          |
|           |             |             |   | Black         |  |  |  |  |  | R-KITYZO-NR0-504 |                  |          |
| YZ        | 125-250     | 2015 > 2021 | OEM 2015 > 2020   | OEM           |  |  |  |  |  |                  | R-KITYZO-OEM-515 | € 134,95 |
|           |             |             |   | White         |  |  |  |  |  | R-KITYZO-BNO-515 |                  |          |
|           |             |             |   | Black         |  |  |  |  |  | R-KITYZO-NR0-515 |                  |          |
| YZ        | 125-250     | 2022-2023   | OEM 2021  | OEM           |  |  |  |  |  |                  | R-KITYZO-BLO-515 | € 134,95 |
|           |             |             |   | OEM           |  |  |  |  |  |                  | R-KITYZO-BLO-022 |          |
|           |             |             |   | White         |  |  |  |  |  | R-KITYZO-BNO-022 |                  |          |
| YZ-X      | 125         | 2020 > 2022 | OEM 2015 > 2020   | OEM           |  |  |  |  |  |                  | R-KITYZO-NR0-022 | € 134,95 |
|           |             |             |   | Quantum Grey  |  |  |  |  |  | R-KITYZO-GRO-022 |                  |          |
|           |             |             |   | OEM           |  |  |  |  |  |                  | R-KITYZO-OEM-515 |          |
| YZ-X      | 250         | 2016 > 2022 | OEM 2015 > 2020   | OEM           |  |  |  |  |  |                  | R-KITYZO-BNO-515 | € 134,95 |
|           |             |             |   | White         |  |  |  |  |  | R-KITYZO-NR0-515 |                  |          |
|           |             |             |   | Black         |  |  |  |  |  | R-KITYZO-BLO-515 |                  |          |
| YZ-X      | 125-250     | 2023        | OEM 2021  | OEM           |  |  |  |  |  |                  | R-KITYZO-OEM-515 | € 134,95 |
|           |             |             |   | White         |  |  |  |  |  | R-KITYZO-BNO-515 |                  |          |
|           |             |             |   | Black         |  |  |  |  |  | R-KITYZO-NR0-515 |                  |          |
| YZ-X      | 125-250     | 2023        | OEM   | OEM           |  |  |  |  |  |                  | R-KITYZO-BLO-022 | € 134,95 |
|           |             |             |   | White         |  |  |  |  |  | R-KITYZO-BNO-022 |                  |          |
|           |             |             |   | Black         |  |  |  |  |  | R-KITYZO-NR0-022 |                  |          |
| YZF       | 400-426     | 1998-1999   | OEM 2015 > 2020   | OEM           |  |  |  |  |  |                  | R-KITYZO-GRO-022 | € 134,95 |
|           |             |             |   | OEM           |  |  |  |  |  |                  | R-KITYZF-OEM-505 |          |
| YZF       | 250-400-426 | 2000 > 2002 | OEM 2015 > 2020   | OEM           |  |  |  |  |  |                  | R-KITYZF-OEM-506 | € 134,95 |
| YZF       | 250-450     | 2003 > 2005 | OEM 2015 > 2020   | White         |  |  |  |  |  |                  | R-KITYZF-BNO-506 | € 134,95 |
|           |             |             |   | OEM           |  |  |  |  |  |                  | R-KITYZF-OEM-507 |          |
| YZF       | 250-450     | 2006 > 2009 | OEM 2015 > 2020   | Black         |  |  |  |  |  |                  | R-KITYZF-NR0-507 | € 134,95 |
|           |             |             |   | OEM           |  |  |  |  |  |                  | R-KITYZF-OEM-508 |          |
| YZF       | 250         | 2014 > 2018 | OEM 2014 > 2017   | OEM           |  |  |  |  |  |                  | R-KITYZF-BNO-508 | € 134,95 |
|           |             |             |   | White         |  |  |  |  |  | R-KITYZF-NR0-508 |                  |          |
|           |             |             |   | Black         |  |  |  |  |  | R-KITYZF-BLO-514 |                  |          |
| YZF       | 250         | 2014 > 2018 | OEM 2014 > 2017   | OEM           |  |  |  |  |  |                  | R-KITYZF-BNO-514 | € 159,95 |
|           |             |             |   | White         |  |  |  |  |  | R-KITYZF-BNO-514 | € 159,95         |          |
|           |             |             |   | Black         |  |  |  |  |  | R-KITYZF-NR0-514 | € 159,95         |          |
|           |             |             |   | Y Yellow      |  |  |  |  |  | R-KITYZF-GY0-514 | € 159,95         |          |
|           |             |             |   | YZ Blue       |  |  |  |  |  | R-KITYZF-BL1-514 | € 159,95         |          |
|           |             |             |   | YZ Blue-White |  |  |  |  |  | R-KITYZF-BL2-514 | € 159,95         |          |
|           |             |             |   | Y Yellow      |  |  |  |  |  | R-KITYZF-GY0-614 | € 269,95         |          |
|           |             |             |   | Neon Yellow   |  |  |  |  |  | R-KITYZF-GF0-614 | € 269,95         |          |
|           |             |             |   | CR Red-Black  |  |  |  |  |  | R-KITYZF-RS0-614 | € 269,95         |          |

**NEW**



# YAMAHA REPLICA PLASTICS KIT / KIT PLASTICHE REPLICA

**OEM** original color -  fluorescent color

| MODEL   | CC      | YEAR        | NOTES                     | COLOR          |  |  |  |  |                  | CODE             | PRICE    |
|---|---------|-------------|---------------------------|----------------|--|--|--|--|------------------|------------------|----------|
| <b>WRF</b><br>kit includes vented front fender  | 450     | 2019 > 2023 | OEM 2020<br>OEM 2021>2023 | YZ Blue-White  |  |  |  |  |                  | R-KITWRF-OEM-419 | € 134,95 |
|   |         |             |                           | YZ Blue        |  |  |  |  |                  | R-KITWRF-BLO-419 |          |
|   |         |             |                           | White-Black    |  |  |  |  |                  | R-KITWRF-BNO-419 |          |
|   |         |             |                           | Y Yellow       |  |  |  |  |                  | R-KITWRF-GYO-419 |          |
|   |         |             |                           | Neon Yellow    |  |  |  |  |                  | R-KITWRF-GFO-419 |          |
|   |         |             |                           | Black          |  |  |  |  |                  | R-KITWRF-NRO-419 |          |
| <b>WRF</b>  | 250-450 | 2003 > 2004 | OEM                       | OEM            |  |  |  |  | R-KITWRF-OEM-401 | € 124,95         |          |
| <b>WRF</b>  | 250-450 | 2005-2006   | OEM                       | OEM            |  |  |  |  | R-KITWRF-OEM-402 | € 124,95         |          |
|   |         |             |                           | White          |  |  |  |  | R-KITWRF-BNO-402 |                  |          |
|   |         |             |                           | YZ Blue        |  |  |  |  | R-KITWRF-BLO-402 |                  |          |
| <b>WRF</b>  | 450     | 2007 > 2011 | OEM                       | OEM            |  |  |  |  | R-KITWRF-OEM-403 | € 124,95         |          |
|   |         |             |                           | YZ Blue-White  |  |  |  |  | R-KITWRF-OEM-413 |                  |          |
|   |         |             |                           | White          |  |  |  |  | R-KITWRF-BNO-403 |                  |          |
|   |         |             |                           | Black          |  |  |  |  | R-KITWRF-NRO-403 |                  |          |
| <b>WRF</b><br>kit includes vented front fender  | 450     | 2012 > 2015 | OEM                       | OEM            |  |  |  |  | R-KITWRF-OEM-404 | € 124,95         |          |
|   |         |             |                           | White          |  |  |  |  | R-KITWRF-BNO-404 |                  |          |
|   |         |             |                           | Black          |  |  |  |  | R-KITWRF-NRO-404 |                  |          |
| <b>YZ-FX</b><br>Radiator shrouds mod. cross YZF 450 2014>2017<br>adaptable to WRF 450 2016>2018<br>Kit includes vented front fender | 450     | 2016 > 2018 | OEM                       | OEM            |  |  |  |  | R-KITWRF-OEM-515 | € 159,95         |          |
|   |         |             |                           | White          |  |  |  |  | R-KITWRF-BNO-515 |                  |          |
|   |         |             |                           | Black          |  |  |  |  | R-KITWRF-NRO-515 |                  |          |
|   |         |             |                           | Y Yellow-White |  |  |  |  | R-KITWRF-GYO-515 |                  |          |
|   |         |             |                           | YZ Blue        |  |  |  |  | R-KITWRF-BLO-515 |                  |          |
| <b>WRF</b><br>Radiator shrouds mod. cross YZF 450 2014>2017<br>adaptable to WRF 250 2015>2019<br>Kit includes vented front fender   | 450     | 2016 > 2018 | OEM                       | YZ Blue-White  |  |  |  |  | R-KITWRF-OEM-415 | € 134,95         |          |
|   |         |             |                           | White-Black    |  |  |  |  | R-KITWRF-BNO-415 | € 134,95         |          |
|   |         |             |                           | Y Yellow       |  |  |  |  | R-KITWRF-GYO-415 | € 134,95         |          |
|   |         |             |                           | Black          |  |  |  |  | R-KITWRF-NRO-415 | € 134,95         |          |
|   |         |             |                           | YZ Blue        |  |  |  |  | R-KITWRF-BLO-415 | € 134,95         |          |
|   |         |             | with gas tank cover       | Y Yellow-White |  |  |  |  | R-KITWRF-GYO-915 | € 224,95         |          |
| <b>WRF</b><br>kit includes vented front fender  | 450     | 2016 > 2018 | OEM                       | YZ Blue-White  |  |  |  |  | R-KITWRF-OEM-515 | € 159,95         |          |
|   |         |             |                           | White-Black    |  |  |  |  | R-KITWRF-BNO-515 |                  |          |
|   |         |             |                           | Y Yellow       |  |  |  |  | R-KITWRF-GYO-515 |                  |          |
|   |         |             |                           | Black          |  |  |  |  | R-KITWRF-NRO-515 |                  |          |
|   |         |             |                           | OEM            |  |  |  |  | R-KITWRF-BLO-515 |                  |          |







## **KAWASAKI**

**Front fender** / Parafango anteriore >**pag 126**

**Vented front fender** / Parafango anteriore ventilato >**pag 127**

**Rear fender** / Parafango posteriore >**pag 128**

**Radiator shrouds** / Convogliatori aria radiatore >**pag 130**

**Side panels** / Tabelle laterali portanumero >**pag 132**

**Front number plate** / Tabella portanumero anteriore >**pag 134**

**Fork protectors** / Parasteli forcella >**pag 135**

**Rear shock mud flap** / Paraspruzzi monoammortizzatore >**pag 136**

**Chain guide** / Cruna guida catena >**pag 136**

**Chain slider** / Slitta scorricatena forcellone >**pag 137**

**Oversize radiator louvers** / Griglie radiatore maggiorate >**pag 137**

**Replica plastics kit** / Kit plastiche replica >**pag 138**

# KAWASAKI FRONT FENDER / PARAFANGO ANTERIORE



R-PAKXFVE0016



R-PAKXFBN0016



R-PAKXFNR0016

## OEM original color

| MODEL | CC          | YEAR        | NOTES                            | COLOR    | CODE          | PRICE   |
|-------|-------------|-------------|----------------------------------|----------|---------------|---------|
| KX    | 65          | 2001 > 2023 | OEM                              | KX Green | R-PAKX0VE0065 | € 25,95 |
|       |             |             |                                  | Black    | R-PAKX0NR0065 |         |
|       |             |             |                                  | White    | R-PAKX0BN0065 |         |
| KLX   | 110         | 2002 > 2009 | OEM 2005 > 2009                  | KX Green | R-PAKX0VE0110 | € 25,95 |
|       |             |             |                                  | Black    | R-PAKX0NR0110 |         |
| KX    | 85          | 1998 > 2013 | OEM                              | KX Green | R-PAKX0VE0085 | € 25,95 |
|       |             |             |                                  | White    | R-PAKX0BN0085 |         |
|       |             |             |                                  | Black    | R-PAKX0NR0085 |         |
| KX    | 100         | 2004 > 2013 | OEM                              | KX Green | R-PAKX0VE0085 | € 25,95 |
|       |             |             |                                  | White    | R-PAKX0BN0085 |         |
|       |             |             |                                  | Black    | R-PAKX0NR0085 |         |
| KX    | 85-100-112  | 2014 > 2023 | OEM                              | KX Green | R-PAKX0VE0014 | € 27,95 |
|       |             |             |                                  | Black    | R-PAKX0NR0014 |         |
|       |             |             |                                  | White    | R-PAKX0BN0014 |         |
| KX    | 125-250-500 | 1993 > 2002 | OEM                              | KX Green | R-PAKX0VE9902 | € 29,95 |
| KX    | 125-250     | 2003 > 2008 | OEM 2005 > 2008<br>OEM 2003-2004 | KX Green | R-PAKX0VE0300 | € 29,95 |
|       |             |             |                                  | KX Green | R-PAKX0VE0304 |         |
|       |             |             |                                  | White    | R-PAKX0BN0300 |         |
| KXF   | 250         | 2004 > 2008 | OEM 2005 > 2008<br>OEM 2003-2004 | Black    | R-PAKX0NR0300 | € 29,95 |
|       |             |             |                                  | KX Green | R-PAKX0VE0300 |         |
|       |             |             |                                  | KX Green | R-PAKX0VE0304 |         |
| KXF   | 250-450     | 2009 > 2012 | OEM                              | White    | R-PAKX0BN0300 | € 29,95 |
|       |             |             |                                  | Black    | R-PAKX0NR0300 |         |
|       |             |             |                                  | KX Green | R-PAKXFVE0009 |         |
| KXF   | 250         | 2013 > 2016 | OEM                              | White    | R-PAKXFBN0009 | € 29,95 |
|       |             |             |                                  | Black    | R-PAKXFNR0009 |         |
|       |             |             |                                  | KX Green | R-PAKXFVE0013 |         |
| KXF   | 250         | 2017 > 2023 | OEM                              | White    | R-PAKXFBN0013 | € 29,95 |
|       |             |             |                                  | Black    | R-PAKXFNR0013 |         |
|       |             |             |                                  | KX Green | R-PAKXFVE0016 |         |
| KXF   | 450         | 2006 > 2008 | OEM<br>OEM 2003-2004             | White    | R-PAKXFBN0016 | € 29,95 |
|       |             |             |                                  | Black    | R-PAKXFNR0016 |         |
|       |             |             |                                  | KX Green | R-PAKX0VE0300 |         |
| KXF   | 450         | 2013 > 2015 | OEM                              | KX Green | R-PAKX0VE0304 | € 29,95 |
|       |             |             |                                  | White    | R-PAKX0BN0300 |         |
|       |             |             |                                  | Black    | R-PAKX0NR0300 |         |
| KXF   | 450         | 2013 > 2015 | OEM                              | KX Green | R-PAKXFVE0013 | € 29,95 |
|       |             |             |                                  | White    | R-PAKXFBN0013 |         |
|       |             |             |                                  | Black    | R-PAKXFNR0013 |         |
| KX    | 450         | 2016 > 2023 | OEM                              | KX Green | R-PAKXFVE0016 | € 29,95 |
|       |             |             |                                  | White    | R-PAKXFBN0016 |         |
|       |             |             |                                  | Black    | R-PAKXFNR0016 |         |
| KX-XC | 250-450     | 2021 > 2023 | OEM                              | KX Green | R-PAKXFVE0016 | € 29,95 |
|       |             |             |                                  | White    | R-PAKXFBN0016 |         |
|       |             |             |                                  | Black    | R-PAKXFNR0016 |         |
| KDX   | 125-250-500 | 1993 > 2002 | OEM                              | KX Green | R-PAKX0VE9902 | € 29,95 |
| KLX   | 250-300     | 1993 > 2002 | OEM                              | KX Green | R-PAKX0VE9902 | € 29,95 |
| KLX R | 450         | 2007 > 2016 | OEM<br>OEM 2003-2004             | KX Green | R-PAKX0VE0300 | € 29,95 |
|       |             |             |                                  | KX Green | R-PAKX0VE0304 |         |
|       |             |             |                                  | Black    | R-PAKX0NR0300 |         |
|       |             |             |                                  | White    | R-PAKX0BN0300 |         |

# KAWASAKI VENTED FRONT FENDER / PARAFANGO ANTERIORE VENTILATO

ALL FENDERS ON THIS PAGE ARE VENTED AIRFLOW MODELS / PARAFANGO CON PRE-TAGLIO PER LA VENTILAZIONE

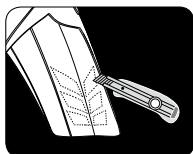

NEON

R-PAKXFVF9916



R-PAKXFBN9916



R-PAKXFGR9916



R-PAKXFVE9916



R-PAKXFNR9916

## AVAILABLE COLORS

- KX Green
- Black
- Neon Green
- White

OEM original color - fluorescent color

| MODEL | CC      | YEAR        | NOTES                                   | COLOR        | CODE | PRICE         |
|-------|---------|-------------|---|--------------|------|---------------|
| KXF   | 250-450 | 2009 > 2012 | OEM - With air flow pre cut             | KX Green     |      | R-PAKXFVE0999 |
|       |         |             | With air flow pre cut                   | Black        |      | R-PAKXFNR0999 |
|       |         |             | With air flow pre cut                   | White        |      | R-PAKXFBN0999 |
| KXF   | 250     | 2013 > 2016 | OEM - With air flow pre cut             | KX Green     |      | R-PAKXFVE9913 |
|       |         |             | With air flow pre cut                   | White        |      | R-PAKXFBN9913 |
|       |         |             | With air flow pre cut                   | Black        |      | R-PAKXFNR9913 |
|       |         |             | With air flow pre cut                   | Neon Green   |      | R-PAKXFVF9913 |
| KXF   | 250     | 2017 > 2023 | OEM - With air flow pre cut             | KX Green     |      | R-PAKXFVE9916 |
|       |         |             | With air flow pre cut                   | White        |      | R-PAKXFBN9916 |
|       |         |             | With air flow pre cut                   | Black        |      | R-PAKXFNR9916 |
|       |         |             | With air flow pre cut                   | Neon Green   |      | R-PAKXFVF9916 |
|       |         |             | With air flow pre cut - Limited Edition | Quantum Grey |      | R-PAKXFGR9916 |
| KXF   | 450     | 2013 > 2015 | OEM - With air flow pre cut             | KX Green     |      | R-PAKXFVE9913 |
|       |         |             | With air flow pre cut                   | White        |      | R-PAKXFBN9913 |
|       |         |             | With air flow pre cut                   | Black        |      | R-PAKXFNR9913 |
|       |         |             | With air flow pre cut                   | Neon Green   |      | R-PAKXFVF9913 |
| KXF   | 450     | 2016 > 2023 | OEM - With air flow pre cut             | KX Green     |      | R-PAKXFVE9916 |
|       |         |             | With air flow pre cut                   | White        |      | R-PAKXFBN9916 |
|       |         |             | With air flow pre cut                   | Black        |      | R-PAKXFNR9916 |
|       |         |             | With air flow pre cut                   | Neon Green   |      | R-PAKXFVF9916 |
|       |         |             | With air flow pre cut - Limited Edition | Quantum Grey |      | R-PAKXFGR9916 |
| KX-XC | 250-450 | 2021 > 2023 | OEM - With air flow pre cut             | KX Green     |      | R-PAKXFVE9916 |
|       |         |             | With air flow pre cut                   | White        |      | R-PAKXFBN9916 |
|       |         |             | With air flow pre cut                   | Black        |      | R-PAKXFNR9916 |
|       |         |             | With air flow pre cut                   | Neon Green   |      | R-PAKXFVF9916 |
|       |         |             | With air flow pre cut - Limited Edition | Quantum Grey |      | R-PAKXFGR9916 |



SUPPORTED BY TECH



R-PPKXFVE0019



R-PPKXFBN0019



R-PPKXFNR0019



R-PPKXFV0019

NEON

## AVAILABLE COLORS





















**OEM** original color - fluorescent color

| MODEL | CC         | YEAR        | NOTES   | COLOR        |  | CODE          | PRICE   |
|-------|------------|-------------|---|--------------|--|---------------|---------|
| KX    | 65         | 2001 > 2023 | OEM 2001 > 2013 and 2016 > 2023<br>OEM 2014-2015              | KX Green     |  | R-PPKX0VE0065 | € 27,95 |
|       |            |             |   | White        |  | R-PPKX0BN0065 |         |
|       |            |             |   | Black        |  | R-PPKX0NR0065 |         |
| KLX   | 110        | 2002 > 2009 | OEM   | KX Green     |  | R-PPKX0VE0065 | € 27,95 |
|       |            |             |   | White        |  | R-PPKX0BN0065 |         |
|       |            |             |   | Black        |  | R-PPKX0NR0065 |         |
| KX    | 85         | 1998 > 2013 | OEM 1998 > 2013   | KX Green     |  | R-PPKX0VE0085 | € 27,95 |
|       |            |             |   | White        |  | R-PPKX0BN0085 |         |
|       |            |             |   | Black        |  | R-PPKX0NR0085 |         |
| KX    | 100        | 2004 > 2013 | OEM   | KX Green     |  | R-PPKX0VE0085 | € 27,95 |
|       |            |             |   | White        |  | R-PPKX0BN0085 |         |
|       |            |             |   | Black        |  | R-PPKX0NR0085 |         |
| KX    | 85-100-112 | 2014 > 2023 | OEM 2016 > 2023<br>OEM 2014-2015                              | KX Green     |  | R-PPKX0VE0014 | € 29,95 |
|       |            |             |   | White        |  | R-PPKX0BN0014 |         |
|       |            |             |   | Black        |  | R-PPKX0NR0014 |         |
| KX    | 125-250    | 1999 > 2002 | OEM 2005 > 2008   | KX Green     |  | R-PPKX0VE9902 | € 31,95 |
| KX    | 125-250    | 2003 > 2008 | OEM 2005 > 2008   | KX Green     |  | R-PPKX0VE0300 | € 31,95 |
|       |            |             |   | White        |  | R-PPKX0BN0300 |         |
|       |            |             |   | Black        |  | R-PPKX0NR0300 |         |
| KXF   | 250        | 2004-2005   | OEM   | KX Green     |  | R-PPRMOVE0004 | € 31,95 |
|       |            |             |   | White        |  | R-PPRMOBN0004 |         |
|       |            |             |   | Black        |  | R-PPRMONR0004 |         |
| KXF   | 250-450    | 2006 > 2008 | OEM   | KX Green     |  | R-PPKXFVE0006 | € 31,95 |
|       |            |             |   | White        |  | R-PPKXFBN0006 |         |
|       |            |             |   | Black        |  | R-PPKXFNR0006 |         |
| KXF   | 250        | 2009 > 2012 | OEM   | KX Green     |  | R-PPKXFVE0009 | € 31,95 |
|       |            |             |   | White        |  | R-PPKXFBN0009 |         |
|       |            |             |   | Black        |  | R-PPKXFNR0009 |         |
| KXF   | 250        | 2013 > 2016 | OEM KXF 250 2016<br>OEM KXF 250 2014-2015<br>OEM KXF 250 2013 | KX Green     |  | R-PPKXFVE0012 | € 29,95 |
|       |            |             |   | White        |  | R-PPKXFBN0012 |         |
|       |            |             |   | Black        |  | R-PPKXFNR0012 |         |
| KXF   | 250        | 2017 > 2020 | OEM   | Neon Green   |  | R-PPKXFV0012  | € 29,95 |
|       |            |             |   | KX Green     |  | R-PPKXFVE0016 |         |
|       |            |             |   | White        |  | R-PPKXFBN0016 |         |
| KX    | 250        | 2021 > 2023 | Limited Edition<br>OEM  | Black        |  | R-PPKXFNR0016 | € 29,95 |
|       |            |             |   | Neon Green   |  | R-PPKXFV0016  |         |
|       |            |             |   | Quantum Grey |  | R-PPKXFG0016  |         |
| KX    | 250        | 2021 > 2023 | OEM   | KX Green     |  | R-PPKXFVE0019 | € 29,95 |
|       |            |             |   | White        |  | R-PPKXFBN0019 |         |
|       |            |             |   | Black        |  | R-PPKXFNR0019 |         |
| KXF   | 450        | 2009 > 2011 | Limited Edition<br>OEM  | Neon Green   |  | R-PPKXFV0019  | € 29,95 |
|       |            |             |   | Quantum Grey |  | R-PPKXFG0019  |         |
|       |            |             |   | KX Green     |  | R-PPKXFVE0009 |         |
| KXF   | 450        | 2012 > 2015 | OEM 2012<br>OEM 2013 > 2015                                   | White        |  | R-PPKXFBN0009 | € 31,95 |
|       |            |             |   | Black        |  | R-PPKXFNR0009 |         |
|       |            |             |   | KX Green     |  | R-PPKXFVE0012 |         |
| KXF   | 450        | 2012 > 2015 | OEM 2012<br>OEM 2013 > 2015                                   | White        |  | R-PPKXFBN0012 | € 29,95 |
|       |            |             |   | Black        |  | R-PPKXFNR0012 |         |
|       |            |             |   | Neon Green   |  | R-PPKXFV0012  |         |

# KAWASAKI REAR FENDER / PARAFANGO POSTERIORE

**OEM** original color -  fluorescent color

| MODEL | CC      | YEAR        | NOTES  | COLOR                           |   | CODE          | PRICE   |
|-------|---------|-------------|--|---------------------------------|---|---------------|---------|
| KXF   | 450     | 2016 > 2018 | OEM  | KX Green                        |  | R-PPKXFVE0016 | € 29,95 |
|       |         |             |  | White                           |  | R-PPKXFBN0016 |         |
|       |         |             |  | Black                           |  | R-PPKXFNR0016 |         |
|       |         |             |  | Neon Green                      |  | R-PPKXFVF0016 |         |
|       |         |             |  | Quantum Grey                    |  | R-PPKXFG0016  |         |
| KLX R | 450     | 2007 > 2016 | Limited Edition<br>OEM - No light hole<br>No light hole<br>No light hole | KX Green                        |  | R-PPKLXVE0007 | € 36,95 |
|       |         |             |  | White                           |  | R-PPKLXBN0007 |         |
|       |         |             |  | Black                           |  | R-PPKLXNR0007 |         |
|       |         |             |  | KX Green                        |  | R-PPKXFVE0019 |         |
|       |         |             |  | White                           |  | R-PPKXFBN0019 |         |
| KX    | 450     | 2019 > 2023 | OEM  | Black                           |  | R-PPKXFNR0019 | € 29,95 |
|       |         |             |  | Neon Green                      |  | R-PPKXFVF0019 |         |
|       |         |             |  | Quantum Grey                    |  | R-PPKXFG0019  |         |
|       |         |             |  | KX Green                        |  | R-PPKXFVE0019 |         |
|       |         |             |  | White                           |  | R-PPKXFBN0019 |         |
| KX-XC | 250-450 | 2021 > 2023 | Limited Edition<br>OEM   | Black                           |  | R-PPKXFNR0019 | € 29,95 |
|       |         |             |  | Neon Green                      |  | R-PPKXFVF0019 |         |
|       |         |             |  | Quantum Grey                    |  | R-PPKXFG0019  |         |
|       |         |             |  | Limited Edition<br>Quantum Grey |  | R-PPKXFG0019  |         |





R-CVKXFBN0019



R-CVKXFNR0019



R-CVKXFVE0019



R-CVKXFVF0019



R-CVKXFGR0019

## AVAILABLE COLORS



**OEM** original color - fluorescent color

| MODEL        | CC            | YEAR        | NOTES  | COLOR            | CODE          | PRICE   |               |
|--------------|---------------|-------------|--|------------------|---------------|---------|---------------|
| KX           | 65            | 2001 > 2023 | OEM 2001 > 2009 and 2012 > 2023<br>OEM 2010-2011       | KX Green         | R-CVKX0VE0065 | € 49,95 |               |
|              |               |             |  | Black            | R-CVKX0NR0065 |         |               |
|              |               |             |  | White            | R-CVKX0BN0065 |         |               |
| KLX          | 110           | 2002 > 2009 | OEM  | KX Green         | R-CVKX0VE0065 | € 49,95 |               |
|              |               |             |  | Black            | R-CVKX0NR0065 |         |               |
|              |               |             |  | White            | R-CVKX0BN0065 |         |               |
| KX           | 85            | 1998 > 2013 | OEM 1998 > 2009 and 2012-2013<br>OEM 2010-2011         | KX Green         | R-CVKX0VE0085 | € 49,95 |               |
|              |               |             |  | Black            | R-CVKX0NR0085 |         |               |
|              |               |             |  | White            | R-CVKX0BN0085 |         |               |
| KX           | 100           | 2004 > 2013 | OEM 1998 > 2009 and 2012-2013<br>OEM 2010-2011         | KX Green         | R-CVKX0VE0085 | € 49,95 |               |
|              |               |             |  | Black            | R-CVKX0NR0085 |         |               |
|              |               |             |  | White            | R-CVKX0BN0085 |         |               |
| KX           | 85-100        | 2014 > 2021 | OEM 2014 > 2020<br>OEM 2021                            | KX Green-Black   | R-CVKX0VENR14 | € 57,95 |               |
|              |               |             |  | KX Green         | R-CVKX0VE0014 |         |               |
|              |               |             |  | Black            | R-CVKX0NR0014 |         |               |
| KX           | 85-112        | 2022-2023   | OEM  | White            | R-CVKX0BN0014 |         |               |
|              |               |             |  | KX Green         | R-CVKX0VE0022 | € 57,95 |               |
|              |               |             |  | Black            | R-CVKX0NR0022 |         |               |
| KX           | 125-250       | 1999 > 2002 | OEM  | White            | R-CVKX0BN0022 |         |               |
|              |               |             |  | KX Green         | R-CVKX0VE9902 | € 57,95 |               |
|              |               |             |  | Black            | R-CVKX0NR0022 |         |               |
| KX           | 125-250       | 2003 > 2008 | OEM 2005 > 2008  | KX Green         | R-CVKX0VE0300 |         | € 57,95       |
|              |               |             |  | Black            | R-CVKX0NR0300 |         |               |
|              |               |             |  | White            | R-CVKX0BN0300 |         |               |
| KXF          | 250           | 2004-2005   | OEM 2005   | KX Green         | R-CVKX0VE0400 | € 57,95 |               |
|              |               |             |  | Black            | R-CVKX0NR0400 |         |               |
|              |               |             |  | White            | R-CVKX0BN0400 |         |               |
| KXF          | 250           | 2006 > 2008 | OEM 2008<br>OEM 2007 - Bi-Color<br>OEM 2006 - Bi-Color | KX Green         | R-CVKXFVE0026 | € 65,95 |               |
|              |               |             |  | KX Green-Black   | R-CVKXFVENR26 |         |               |
|              |               |             |  | Black-KX Green   | R-CVKXFNRV26  |         |               |
|              |               |             |  | White            | R-CVKXFBN0026 |         |               |
|              |               |             |  | Black            | R-CVKXFNR0026 |         |               |
|              |               |             |  | Black            | R-CVKXFNR0026 |         |               |
| KXF          | 250           | 2009 > 2012 | OEM 2009 and 2012                                      | KX Green-Black   | R-CVKXFVENR29 | € 65,95 |               |
|              |               |             |  | KX Green         | R-CVKXFVE0029 |         |               |
|              |               |             |  | White            | R-CVKXFBN0029 |         |               |
|              |               |             |  | Black            | R-CVKXFNR0029 |         |               |
| KXF          | 250           | 2013 > 2016 | OEM  | KX Green-Black   | R-CVKXFVENR13 | € 65,95 |               |
|              |               |             |  | White            | R-CVKXFBN0013 |         |               |
|              |               |             |  | Black            | R-CVKXFNR0013 |         |               |
|              |               |             |  | Neon Green-Black | R-CVKXFVFN13  |         |               |
|              |               |             |  | Black            | R-CVKXFNR0013 |         |               |
| KXF          | 250           | 2017 > 2020 | OEM 2019<br>OEM 2017/2018/2020                         | KX Green         | R-CVKXFVE0017 | € 65,95 |               |
|              |               |             |  | KX Green-Black   | R-CVKXFVENR17 |         |               |
|              |               |             |  | White            | R-CVKXFBN0017 |         |               |
|              |               |             |  | Black            | R-CVKXFNR0017 |         |               |
|              |               |             |  | Neon Green-Black | R-CVKXFVFN17  |         |               |
|              |               |             |  | Quantum Grey     | R-CVKXFGR0017 |         |               |
| KX           | 250           | 2021 > 2023 | OEM  | Limited Edition  | R-CVKXFVE0019 | € 59,95 |               |
|              |               |             |  | OEM              | KX Green      |         | R-CVKXFVE0019 |
|              |               |             |  | White            | R-CVKXFBN0019 |         |               |
|              |               |             |  | Black            | R-CVKXFNR0019 |         |               |
|              |               |             |  | Limited Edition  | Neon Green    |         | R-CVKXFVF0019 |
| Quantum Grey | R-CVKXFGR0019 |             |  |                  |               |         |               |

**OEM** original color -  fluorescent color

| MODEL | CC      | YEAR        | NOTES  | COLOR            |   | CODE          | PRICE   |
|-------|---------|-------------|--|------------------|---|---------------|---------|
| KXF   | 450     | 2006 > 2008 | OEM 2008<br>OEM 2007 - Bi-Color<br>OEM 2006 - Bi-Color | KX Green         |    | R-CVKXFVE0046 | € 65,95 |
|       |         |             |  | KX Green-Black   |    | R-CVKXFVENR46 |         |
|       |         |             |  | Black-KX Green   |    | R-CVKXFNRVE46 |         |
|       |         |             |  | White            |    | R-CVKXFBN0046 |         |
| KXF   | 450     | 2009 > 2011 | OEM 2010-2011  | Black            |    | R-CVKXFNR0046 | € 65,95 |
|       |         |             |  | Black-KX Green   |    | R-CVKXFNRVE49 |         |
|       |         |             |  | White            |    | R-CVKXFBN0049 |         |
|       |         |             |  | Black            |    | R-CVKXFNR0049 |         |
| KXF   | 450     | 2012 > 2015 | OEM  | KX Green         |    | R-CVKXFVE0049 | € 65,95 |
|       |         |             |  | KX Green-Black   |    | R-CVKXFVENR12 |         |
|       |         |             |  | White            |    | R-CVKXFBN0012 |         |
| KXF   | 450     | 2016 > 2018 | OEM  | Black            |    | R-CVKXFNR0012 | € 65,95 |
|       |         |             |  | KX Green-Black   |    | R-CVKXFVENR16 |         |
|       |         |             |  | White            |    | R-CVKXFBN0016 |         |
| KX    | 450     | 2019 > 2023 | OEM  | Black            |    | R-CVKXFNR0016 | € 65,95 |
|       |         |             |  | Neon Green-Black |    | R-CVKXFVFN16  |         |
|       |         |             |  | KX Green         |    | R-CVKXFVE0019 |         |
|       |         |             |  | White            |    | R-CVKXFBN0019 |         |
|       |         |             |  | Black            |    | R-CVKXFNR0019 |         |
| KX-XC | 250-450 | 2021 > 2023 | OEM  | Neon Green       |    | R-CVKXFVFN019 | € 59,95 |
|       |         |             |  | Quantum Grey     |    | R-CVKXFGR0019 |         |
|       |         |             |  | KX Green         |   | R-CVKXFVE0019 |         |
|       |         |             |  | White            |  | R-CVKXFBN0019 |         |
| KLX R | 450     | 2007 > 2016 | OEM 2013 > 2016<br>OEM 2007 > 2012                     | Black            |  | R-CVKXFNR0019 | € 65,95 |
|       |         |             |  | Black-KX Green   |  | R-CVKXFNR0019 |         |
|       |         |             |  | KX Green-Black   |  | R-CVKXFVFN019 |         |
|       |         |             |  | Black            |  | R-CVKXFGR0019 |         |
| KLX R | 450     | 2007 > 2016 | Limited Edition  | Quantum Grey     |  | R-CVKXFGR0019 | € 65,95 |
|       |         |             |  | Black-KX Green   |  | R-CVKLXNRVE07 |         |
|       |         |             |  | KX Green-Black   |  | R-CVKLXVNR07  |         |
| KLX R | 450     | 2007 > 2016 | Limited Edition  | Black            |  | R-CVKLXNR0007 | € 65,95 |
|       |         |             |  | KX Green         |  | R-CVKLXVE0007 |         |

ph mediacross



# KAWASAKI SIDE PANELS / TABELLE LATERALI PORTANUMERO



R-FIKXFVE0019

















## AVAILABLE COLORS



**OEM** original color - fluorescent color

| MODEL | CC         | YEAR        | NOTES                                    | COLOR          | CODE          | PRICE   |
|-------|------------|-------------|--|----------------|---------------|---------|
| KX    | 65         | 2001 > 2023 | OEM 2020 > 2023<br>OEM 2001 > 2019       | KX Green       | R-FIKX0VE0065 | € 49,95 |
|       |            |             |  | White          | R-FIKX0BN0065 |         |
|       |            |             |  | Black          | R-FIKX0NR0065 |         |
| KLX   | 110        | 2002 > 2009 | OEM                                      | KX Green       | R-FIKX0VE0065 | € 49,95 |
|       |            |             |  | White          | R-FIKX0BN0065 |         |
|       |            |             |  | Black          | R-FIKX0NR0065 |         |
| KX    | 85         | 1998 > 2013 | OEM                                      | White          | R-FIKX0BN0085 | € 49,95 |
| KX    | 100        | 2004 > 2013 | OEM                                      | Black          | R-FIKX0NR0085 | € 49,95 |
|       |            |             |  | White          | R-FIKX0BN0085 |         |
| KX    | 85-100-112 | 2014 > 2023 | OEM 2020 > 2023<br>OEM 2014 > 2019       | KX Green       | R-FIKX0VE0014 | € 54,95 |
|       |            |             |  | White          | R-FIKX0BN0014 |         |
|       |            |             |  | Black          | R-FIKX0NR0014 |         |
| KX    | 125-250    | 1999 > 2002 | OEM                                      | White          | R-FIKX0BN9902 | € 57,95 |
| KX    | 125-250    | 2003 > 2008 | OEM                                      | White          | R-FIKX0BN0300 | € 57,95 |
|       |            |             |  | Black          | R-FIKX0NR0300 |         |
|       |            |             |  | White          | R-FIRM0BN0004 |         |
| KXF   | 250        | 2004-2005   | OEM                                      | Black          | R-FIKXFNR0026 | € 65,95 |
| KXF   | 250        | 2006 > 2008 | OEM 2006-2007                            | White          | R-FIKXFBN0026 | € 65,95 |
|       |            |             |  | Black-KX Green | R-FIKXFNRVE29 |         |
|       |            |             |  | White-KX Green | R-FIKXFBNVE29 |         |
| KXF   | 250        | 2009 > 2012 | OEM KX 250 2009 > 2012                   | KX Green       | R-FIKXFVE0029 | € 65,95 |
|       |            |             |  | White          | R-FIKXFBN0029 |         |
|       |            |             |  | Black          | R-FIKXFNR0029 |         |
| KXF   | 250        | 2013 > 2016 | OEM KX 250 2014-2016<br>OEM KXF 250 2013 | KX Green       | R-FIKXFVE0012 | € 65,95 |
|       |            |             |  | White          | R-FIKXFBN0012 |         |
|       |            |             |  | Black          | R-FIKXFNR0012 |         |
| KXF   | 250        | 2017 > 2020 | OEM 2020<br>OEM 2017 > 2019              | Neon Green     | R-FIKXFVF0012 | € 59,95 |
|       |            |             |  | KX Green       | R-FIKXFVE0016 |         |
|       |            |             |  | White          | R-FIKXFBN0016 |         |
| KX    | 250        | 2021 > 2023 | Limeted Edition<br>OEM                   | Black          | R-FIKXFNR0016 | € 59,95 |
|       |            |             |  | Neon Green     | R-FIKXFVF0016 |         |
|       |            |             |  | Quantum Grey   | R-FIKXFGR0016 |         |
| KX    | 250        | 2021 > 2023 | OEM                                      | KX Green       | R-FIKXFVE0019 | € 59,95 |
|       |            |             |  | White          | R-FIKXFBN0019 |         |
|       |            |             |  | Black          | R-FIKXFNR0019 |         |
| KXF   | 450        | 2006 > 2008 | Limeted Edition<br>OEM                   | Neon Green     | R-FIKXFVF0019 | € 65,95 |
|       |            |             |  | Quantum Grey   | R-FIKXFGR0019 |         |
|       |            |             |  | White          | R-FIKXFBN0046 |         |
| KXF   | 450        | 2009 > 2011 | OEM KXF 450 2009 > 2011                  | Black          | R-FIKXFNR0046 | € 65,95 |
|       |            |             |  | White-KX Green | R-FIKXFBNVE29 |         |
|       |            |             |  | Black-KX Green | R-FIKXFNRVE29 |         |
| KXF   | 450        | 2012 > 2015 | OEM KXF 450 2012 > 2015                  | KX Green       | R-FIKXFVE0029 | € 65,95 |
|       |            |             |  | White          | R-FIKXFBN0029 |         |
|       |            |             |  | Black          | R-FIKXFNR0029 |         |
| KXF   | 450        | 2016 > 2018 | OEM                                      | KX Green       | R-FIKXFVE0012 | € 65,95 |
|       |            |             |  | White          | R-FIKXFBN0012 |         |
|       |            |             |  | Black          | R-FIKXFNR0012 |         |
| KXF   | 450        | 2016 > 2018 | OEM                                      | Neon Green     | R-FIKXFVF0012 | € 59,95 |
|       |            |             |  | KX Green       | R-FIKXFVE0016 |         |
|       |            |             |  | White          | R-FIKXFBN0016 |         |
| KXF   | 450        | 2016 > 2018 | Limeted Edition                          | Black          | R-FIKXFNR0016 | € 59,95 |
|       |            |             |  | Neon Green     | R-FIKXFVF0016 |         |
|       |            |             |  | Quantum Grey   | R-FIKXFGR0016 |         |

**OEM** original color -  fluorescent color

| MODEL | CC      | YEAR        | NOTES  | COLOR        | CODE  | PRICE   |
|-------|---------|-------------|--|--------------|---|---------|
| KXF   | 450     | 2016 > 2018 | OEM - USA version<br>USA version<br>USA version<br>USA version - Limited Edition | KX Green     |  R-FIKXFVE9916 | € 59,95 |
|       |         |             |  | White        |  R-FIKXFBN9916 |         |
|       |         |             |  | Black        |  R-FIKXFNR9916 |         |
|       |         |             |  | Neon Green   |  R-FIKXFVF9916 |         |
| KXF   | 450     | 2019 > 2023 | OEM 2020 > 2023<br>OEM 2019  | KX Green     |  R-FIKXFVE0019 | € 59,95 |
|       |         |             |  | White        |  R-FIKXFBN0019 |         |
|       |         |             |  | Black        |  R-FIKXFNR0019 |         |
|       |         |             |  | Neon Green   |  R-FIKXFVF0019 |         |
|       |         |             |  | Quantum Grey |  R-FIKXFGR0019 |         |
|       |         |             |  | KX Green     |  R-FIKXFVE0019 |         |
| KX-XC | 250-450 | 2021 > 2023 | Limeted Edition<br>OEM   | White        |  R-FIKXFBN0019 | € 59,95 |
|       |         |             |  | Black        |  R-FIKXFNR0019 |         |
|       |         |             |  | Neon Green   |  R-FIKXFVF0019 |         |
|       |         |             |  | Quantum Grey |  R-FIKXFGR0019 |         |
| KLXR  | 450     | 2007 > 2016 | Limeted Edition<br>OEM   | White        |  R-FIKLXBN0007 | € 65,95 |
|       |         |             |  | Black        |  R-FIKLXNR0007 |         |
|       |         |             |  |              |   |         |

 **NEON**

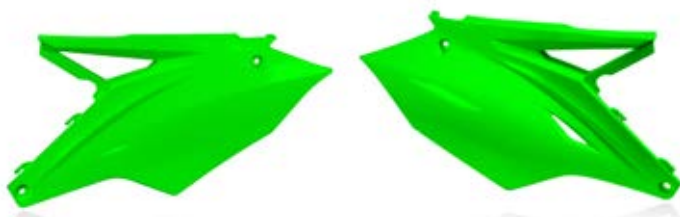

R-FIKXFVF0016

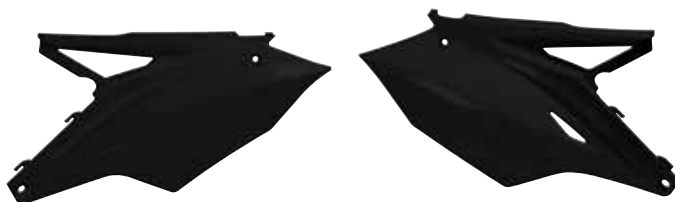

R-FIKXFNR0016



R-FIKXFGR0019



R-FIKXFBN0019

# KAWASAKI FRONT NUMBER PLATE / TABELLA PORTANUMERO ANTERIORE



R-TBKXFVE0016



R-TBKXFBN0016



R-TBKXFGR0016



R-TBKXFNR0016



R-TBKXFVF0016

## AVAILABLE COLORS



**DEM** original color - fluorescent color

| MODEL | CC         | YEAR        | NOTES                                       | COLOR        |  | CODE          | PRICE   |
|-------|------------|-------------|---|--------------|--|---------------|---------|
| KX    | 65         | 2001 > 2023 | OEM 2020 > 2023<br>OEM 2001 > 2019          | KX Green     |  | R-TBKX0VE0065 | € 23,95 |
|       |            |             |   | White        |  | R-TBKX0BN0065 |         |
|       |            |             |   | Black        |  | R-TBKX0NR0065 |         |
| KLX   | 110        | 2002 > 2009 | OEM   | KX Green     |  | R-TBKX0VE0065 | € 23,95 |
|       |            |             |   | White        |  | R-TBKX0BN0065 |         |
|       |            |             |   | Black        |  | R-TBKX0NR0065 |         |
|       |            |             |   | Black        |  | R-TBKX0BN0085 |         |
| KX    | 85         | 2001 > 2013 | OEM   | White        |  | R-TBKX0BN0085 | € 23,95 |
| KX    | 100        | 2004 > 2013 | OEM   | White        |  | R-TBKX0BN0085 | € 23,95 |
|       |            |             |   | Black        |  | R-TBKX0NR0085 |         |
| KX    | 85-100-112 | 2014 > 2023 | OEM 2020 > 2023                             | KX Green     |  | R-TBKX0VE0014 | € 25,95 |
|       |            |             |   | White        |  | R-TBKX0BN0014 |         |
|       |            |             |   | Black        |  | R-TBKX0NR0014 |         |
| KX    | 125-250    | 1994 > 2002 | OEM   | White        |  | R-TBKX0BN9902 | € 28,95 |
| KX    | 125-250    | 2003 > 2008 | OEM KX 2003 > 2008                          | White        |  | R-TBKX0BN0300 | € 28,95 |
|       |            |             |   | Black        |  | R-TBKX0NR0300 |         |
|       |            |             |   | Black        |  | R-TBKX0BN9902 |         |
| KXF   | 250        | 2004 > 2008 | OEM 2003 > 2008                             | White        |  | R-TBKX0BN0300 | € 28,95 |
| KXF   | 450        | 2006 > 2008 | OEM   | White        |  | R-TBKX0BN0300 | € 28,95 |
|       |            |             |   | Black        |  | R-TBKX0NR0300 |         |
|       |            |             |   | KX Green     |  | R-TBKXFVE0009 |         |
| KXF   | 250-450    | 2009 > 2012 | OEM KXF 250<br>OEM KXF 450                  | White        |  | R-TBKXFBN0009 | € 28,95 |
|       |            |             |   | Black        |  | R-TBKXFNR0009 |         |
|       |            |             |   | Black        |  | R-TBKXFNR0009 |         |
| KXF   | 250        | 2013 > 2016 | OEM KXF 250 2014 > 2016<br>OEM KXF 250 2013 | KX Green     |  | R-TBKXFVE0013 | € 28,95 |
|       |            |             |   | White        |  | R-TBKXFBN0013 |         |
|       |            |             |   | Black        |  | R-TBKXFNR0013 |         |
|       |            |             |   | Neon Green   |  | R-TBKXFVF0013 |         |
| KXF   | 250        | 2017 > 2023 | OEM 2020 > 2023<br>OEM 2017 > 2019          | KX Green     |  | R-TBKXFVE0016 | € 28,95 |
|       |            |             |   | White        |  | R-TBKXFBN0016 |         |
|       |            |             |   | Black        |  | R-TBKXFNR0016 |         |
|       |            |             |   | Neon Green   |  | R-TBKXFVF0016 |         |
|       |            |             |   | Quantum Grey |  | R-TBKXFGR0016 |         |
| KXF   | 450        | 2013 > 2015 | Limited Edition<br>OEM                      | KX Green     |  | R-TBKXFVE0013 | € 28,95 |
|       |            |             |   | White        |  | R-TBKXFBN0013 |         |
|       |            |             |   | Black        |  | R-TBKXFNR0013 |         |
|       |            |             |   | Neon Green   |  | R-TBKXFVF0013 |         |
| KXF   | 450        | 2016 > 2023 | OEM 2020 > 2023<br>OEM 2016 > 2019          | KX Green     |  | R-TBKXFVE0016 | € 28,95 |
|       |            |             |   | White        |  | R-TBKXFBN0016 |         |
|       |            |             |   | Black        |  | R-TBKXFNR0016 |         |
|       |            |             |   | Neon Green   |  | R-TBKXFVF0016 |         |
|       |            |             |   | Quantum Grey |  | R-TBKXFGR0016 |         |
| KX-XC | 250-450    | 2021 > 2023 | OEM   | KX Green     |  | R-TBKXFVE0016 | € 28,95 |
|       |            |             |   | White        |  | R-TBKXFBN0016 |         |
|       |            |             |   | Black        |  | R-TBKXFNR0016 |         |
|       |            |             |   | Neon Green   |  | R-TBKXFVF0016 |         |
|       |            |             |   | Quantum Grey |  | R-TBKXFGR0016 |         |
|       |            |             | Limited Edition                             |              |  |               |         |

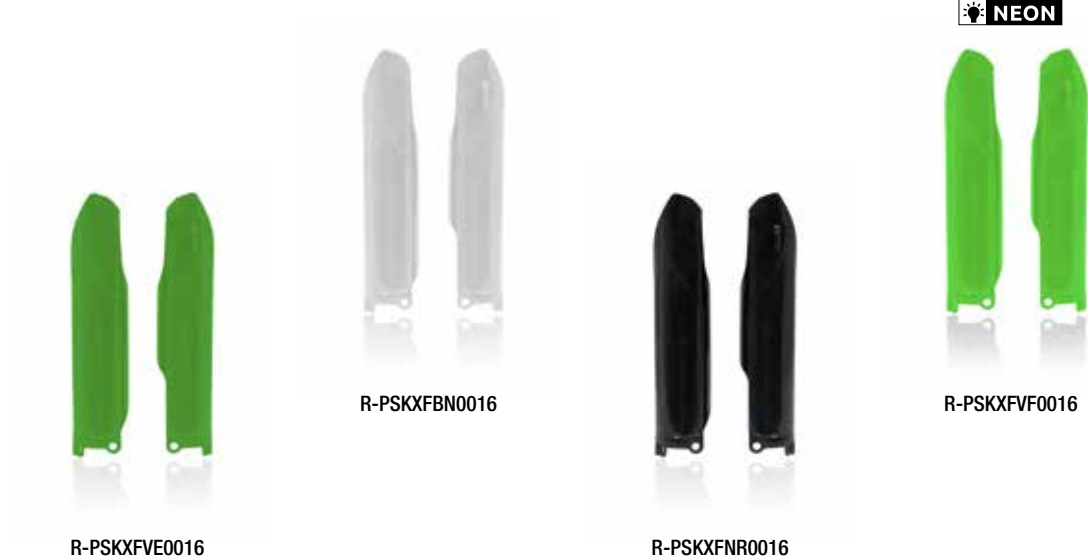

## AVAILABLE COLORS



**OEM** original color - fluorescent color

| MODEL | CC          | YEAR        | NOTES  | COLOR        | CODE          | PRICE   |
|-------|-------------|-------------|--|--------------|---------------|---------|
| KX    | 85          | 2001 > 2013 | OEM 2010 > 2013  | White        | R-PSKX0BN0085 | € 28,95 |
|       |             |             |  | Black        | R-PSKX0NR0085 |         |
| KX    | 100         | 2004 > 2013 | OEM 2010 > 2013  | White        | R-PSKX0BN0085 | € 28,95 |
|       |             |             |  | Black        | R-PSKX0NR0085 |         |
| KX    | 85-100-112  | 2014 > 2023 | OEM  | KX Green     | R-PSKX0VE0014 | € 29,95 |
|       |             |             |  | White        | R-PSKX0BN0014 |         |
|       |             |             |  | Black        | R-PSKX0NR0014 |         |
| KX    | 125-250-500 | 1994 > 2003 | OEM  | Neutral      | R-PSKX0NT0003 | € 34,95 |
| KX    | 125-250     | 2004 > 2006 | OEM  | Neutral      | R-PSKX0NT0004 | € 34,95 |
|       |             |             |  | White        | R-PSKX0BN0004 |         |
|       |             |             |  | Black        | R-PSKX0NR0004 |         |
| KX    | 125-250     | 2007-2008   | OEM  | Neutral      | R-PSKXFNT0006 | € 34,95 |
|       |             |             |  | White        | R-PSKXFBN0006 |         |
|       |             |             |  | Black        | R-PSKXFNR0006 |         |
| KXF   | 250         | 2004-2005   | OEM  | Neutral      | R-PSKX0NT0004 | € 34,95 |
|       |             |             |  | White        | R-PSKX0BN0004 |         |
|       |             |             |  | Black        | R-PSKX0NR0004 |         |
| KXF   | 250-450     | 2006 > 2008 | OEM  | Neutral      | R-PSKXFNT0006 | € 34,95 |
|       |             |             |  | White        | R-PSKXFBN0006 |         |
|       |             |             |  | Black        | R-PSKXFNR0006 |         |
| KXF   | 250         | 2009 > 2016 | OEM  | KX Green     | R-PSKXFVE0009 | € 34,95 |
|       |             |             |  | White        | R-PSKXFBN0009 |         |
|       |             |             |  | Black        | R-PSKXFNR0009 |         |
| KX    | 250         | 2017 > 2023 | OEM  | KX Green     | R-PSKXFVE0016 | € 34,95 |
|       |             |             |  | White        | R-PSKXFBN0016 |         |
|       |             |             |  | Black        | R-PSKXFNR0016 |         |
|       |             |             |  | Neon Green   | R-PSKXFVF0016 |         |
|       |             |             |  | Quantum Grey | R-PSKXFGR0016 |         |
| KXF   | 450         | 2009 > 2015 | OEM  | KX Green     | R-PSKXFVE0009 | € 34,95 |
|       |             |             |  | White        | R-PSKXFBN0009 |         |
|       |             |             |  | Black        | R-PSKXFNR0009 |         |
| KXF   | 450         | 2016 > 2023 | OEM  | KX Green     | R-PSKXFVE0016 | € 34,95 |
|       |             |             |  | White        | R-PSKXFBN0016 |         |
|       |             |             |  | Black        | R-PSKXFNR0016 |         |
|       |             |             |  | Neon Green   | R-PSKXFVF0016 |         |
|       |             |             |  | Quantum Grey | R-PSKXFGR0016 |         |
| KX-XC | 250-450     | 2021 > 2023 | OEM  | KX Green     | R-PSKXFVE0016 | € 34,95 |
|       |             |             |  | White        | R-PSKXFBN0016 |         |
|       |             |             |  | Black        | R-PSKXFNR0016 |         |
|       |             |             |  | Neon Green   | R-PSKXFVF0016 |         |
|       |             |             |  | Quantum Grey | R-PSKXFGR0016 |         |
| KLX R | 450         | 2007 > 2016 | OEM - Without tachimeter cable guide<br>Without tachimeter cable guide<br>Without tachimeter cable guide | Black        | R-PSKXFNR0006 | € 34,95 |
|       |             |             |  | Neutral      | R-PSKXFNT0006 |         |
|       |             |             |  | White        | R-PSKXFBN0006 |         |

# KAWASAKI REAR SHOCK MUD FLAP / PARASPRUZZI MONOAMMORTIZZATORE



R-PSPKXFVE016



R-PSPKXFNR016

## AVAILABLE COLORS

KX Green Black

OEM original color

| MODEL | CC      | YEAR        | NOTES | COLOR    | CODE          | PRICE   |
|-------|---------|-------------|-------|----------|---------------|---------|
| KX    | 85-100  | 2014 > 2023 | OEM   | Black    | R-PSPKX0NR014 | € 18,95 |
| KX    | 125-250 | 2003 > 2008 | OEM   | Black    | R-PSPKX0NR000 | € 18,95 |
| KXF   | 250     | 2004 > 2016 | OEM   | Black    | R-PSPKXFNR006 | € 18,95 |
| KXF   | 250     | 2017 > 2020 | OEM   | KX Green | R-PSPKXFVE006 |         |
| KXF   | 250     | 2017 > 2020 | OEM   | Black    | R-PSPKXFNR016 | € 18,95 |
| KXF   | 250     | 2017 > 2020 | OEM   | KX Green | R-PSPKXFVE016 |         |
| KXF   | 250     | 2021 > 2023 | OEM   | Black    | R-PSPKXFNR019 | € 18,95 |
| KXF   | 250     | 2021 > 2023 | OEM   | KX Green | R-PSPKXFVE019 |         |
| KXF   | 450     | 2004 > 2015 | OEM   | Black    | R-PSPKXFNR006 | € 18,95 |
| KXF   | 450     | 2004 > 2015 | OEM   | KX Green | R-PSPKXFVE006 |         |
| KXF   | 450     | 2016 > 2018 | OEM   | Black    | R-PSPKXFNR016 | € 18,95 |
| KXF   | 450     | 2016 > 2018 | OEM   | KX Green | R-PSPKXFVE016 |         |
| KXF   | 450     | 2019 > 2023 | OEM   | Black    | R-PSPKXFNR019 | € 18,95 |
| KXF   | 450     | 2019 > 2023 | OEM   | KX Green | R-PSPKXFVE019 |         |
| KX-XC | 250-450 | 2021 > 2023 | OEM   | Black    | R-PSPKXFNR019 | € 18,95 |
| KX-XC | 250-450 | 2021 > 2023 | OEM   | KX Green | R-PSPKXFVE019 |         |
| KLX R | 450     | 2007 > 2016 | OEM   | Black    | R-PSPKXFNR006 | € 18,95 |
| KLX R | 450     | 2007 > 2016 | OEM   | KX Green | R-PSPKXFVE006 |         |

# KAWASAKI CHAIN GUIDE / CRUNA GUIDA CATENA



R-CRUKXFRS006



R-CRUKXFNR006



R-CRUKXFVE006

## AVAILABLE COLORS

KX Green Black Red

OEM original color

| MODEL | CC      | YEAR        | NOTES | COLOR    | CODE          | PRICE   |
|-------|---------|-------------|-------|----------|---------------|---------|
| KX    | 85-100  | 2000 > 2023 | OEM   | Black    | R-CRUKX0NR014 | € 25,95 |
| KX    | 85-100  | 2000 > 2023 | OEM   | KX Green | R-CRUKX0VE014 |         |
| KX    | 125-250 | 2003 > 2008 | OEM   | Black    | R-CRUKXFNR004 | € 25,95 |
| KX    | 125-250 | 2003 > 2008 | OEM   | KX Green | R-CRUKXFVE004 |         |
| KXF   | 250     | 2004 > 2005 | OEM   | Black    | R-CRUKXFNR004 | € 25,95 |
| KXF   | 250     | 2004 > 2005 | OEM   | KX Green | R-CRUKXFVE004 |         |
| KXF   | 250-450 | 2006 > 2008 | OEM   | Black    | R-CRUKXFNR006 | € 25,95 |
| KXF   | 250-450 | 2006 > 2008 | OEM   | KX Green | R-CRUKXFVE006 |         |
| KXF   | 250-450 | 2006 > 2008 | OEM   | Red      | R-CRUKXFRS006 |         |
| KXF   | 250-450 | 2009 > 2023 | OEM   | Black    | R-CRUKXFNR009 | € 25,95 |
| KXF   | 250-450 | 2009 > 2023 | OEM   | KX Green | R-CRUKXFVE009 |         |
| KXF   | 250-450 | 2009 > 2023 | OEM   | Red      | R-CRUKXFRS009 |         |
| KX-XC | 250-450 | 2021 > 2023 | OEM   | Black    | R-CRUKXFNR009 | € 25,95 |
| KX-XC | 250-450 | 2021 > 2023 | OEM   | KX Green | R-CRUKXFVE009 |         |
| KX-XC | 250-450 | 2021 > 2023 | OEM   | Red      | R-CRUKXFRS009 |         |
| KLXR  | 450     | 2007 > 2011 | OEM   | Black    | R-CRUKXFNR006 | € 25,95 |
| KLXR  | 450     | 2007 > 2011 | OEM   | KX Green | R-CRUKXFVE006 |         |
| KLXR  | 450     | 2007 > 2011 | OEM   | Red      | R-CRUKXFRS006 |         |
| KLXR  | 450     | 2012 > 2016 | OEM   | Black    | R-CRUKXFNR009 | € 25,95 |
| KLXR  | 450     | 2012 > 2016 | OEM   | KX Green | R-CRUKXFVE009 |         |
| KLXR  | 450     | 2012 > 2016 | OEM   | Red      | R-CRUKXFRS009 |         |



MONOBLOCK R2.0 WORX CHAIN GUIDE - PAG. 254

## KAWASAKI CHAIN SLIDER / SLITTA SCORRICATENA FORCELLONE



R-SLIKXFNR016



R-SLIKXFVE016

### AVAILABLE COLORS

- KX Green
- Black

**OEM** original color

| MODEL | CC         | YEAR        | NOTES | COLOR    | CODE   | PRICE   |
|-------|------------|-------------|-------|----------|--|---------|
| KX    | 85-100-112 | 2000 > 2023 | OEM   | Black    | <span style="color: black;">■</span> R-SLIKX0NR014 | € 25,95 |
|       |            |             |       | KX Green | <span style="color: green;">■</span> R-SLIKX0VE014 |         |
| KX    | 125-250    | 1994 > 2008 | OEM   | Black    | <span style="color: black;">■</span> R-SLIKX0NR003 | € 25,95 |
|       |            |             |       | KX Green | <span style="color: green;">■</span> R-SLIKX0VE003 |         |
| KXF   | 250        | 2004-2005   | OEM   | Black    | <span style="color: black;">■</span> R-SLIKXFNR004 | € 25,95 |
|       |            |             |       | KX Green | <span style="color: green;">■</span> R-SLIKXFVE004 |         |
| KXF   | 250-450    | 2006 > 2008 | OEM   | Black    | <span style="color: black;">■</span> R-SLIKXFNR006 | € 25,95 |
|       |            |             |       | KX Green | <span style="color: green;">■</span> R-SLIKXFVE006 |         |
| KXF   | 250        | 2009 > 2016 | OEM   | Black    | <span style="color: black;">■</span> R-SLIKXFNR009 | € 25,95 |
|       |            |             |       | KX Green | <span style="color: green;">■</span> R-SLIKXFVE009 |         |
| KXF   | 250        | 2017 > 2020 | OEM   | Black    | <span style="color: black;">■</span> R-SLIKXFNR016 | € 25,95 |
|       |            |             |       | KX Green | <span style="color: green;">■</span> R-SLIKXFVE016 |         |
| KXF   | 250        | 2021 > 2023 | OEM   | Black    | <span style="color: black;">■</span> R-SLIKXFNR019 | € 25,95 |
|       |            |             |       | KX Green | <span style="color: green;">■</span> R-SLIKXFVE019 |         |
| KXF   | 450        | 2009 > 2015 | OEM   | Black    | <span style="color: black;">■</span> R-SLIKXFNR009 | € 25,95 |
|       |            |             |       | KX Green | <span style="color: green;">■</span> R-SLIKXFVE009 |         |
| KXF   | 450        | 2016 > 2018 | OEM   | Black    | <span style="color: black;">■</span> R-SLIKXFNR016 | € 25,95 |
|       |            |             |       | KX Green | <span style="color: green;">■</span> R-SLIKXFVE016 |         |
| KXF   | 450        | 2019 > 2023 | OEM   | Black    | <span style="color: black;">■</span> R-SLIKXFNR019 | € 25,95 |
|       |            |             |       | KX Green | <span style="color: green;">■</span> R-SLIKXFVE019 |         |
| KX-XC | 250-450    | 2021 > 2023 | OEM   | Black    | <span style="color: black;">■</span> R-SLIKXFNR019 | € 25,95 |
|       |            |             |       | KX Green | <span style="color: green;">■</span> R-SLIKXFVE019 |         |
| KLX R | 450        | 2007 > 2016 | OEM   | Black    | <span style="color: black;">■</span> R-SLIKXFNR006 | € 25,95 |
|       |            |             |       | KX Green | <span style="color: green;">■</span> R-SLIKXFVE006 |         |

## KAWASAKI OVERSIZE RADIATOR LOUVERS / GRIGLIE RADIATORE MAGGIORATE

Total protection of the bottom part of the stock radiator, it fully covers the part that with the standard louver remains without a shield against ground and stones.

*Protezione totale della parte inferiore del radiatore di serie. Copre integralmente la vaschetta che nella versione standard rimane invece esposta agli urti di terra e sassi.*



R-GRKXFVE0019



R-GRKXFNR0019

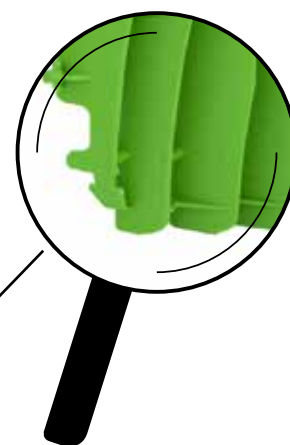

**OEM** original color

### AVAILABLE COLORS

- KX Green
- Black

| MODEL | CC      | YEAR        | NOTES | COLOR    | CODE   | PRICE   |
|-------|---------|-------------|-------|----------|--|---------|
| KXF   | 250     | 2021 > 2023 | OEM   | Black    | <span style="color: black;">■</span> R-GRKXFNR0019 | € 36,95 |
|       |         |             |       | KX Green | <span style="color: green;">■</span> R-GRKXFVE0019 |         |
| KXF   | 450     | 2016 > 2023 | OEM   | Black    | <span style="color: black;">■</span> R-GRKXFNR0019 | € 36,95 |
|       |         |             |       | KX Green | <span style="color: green;">■</span> R-GRKXFVE0019 |         |
| KX-XC | 250-450 | 2021 > 2023 | OEM   | Black    | <span style="color: black;">■</span> R-GRKXFNR0019 | € 36,95 |
|       |         |             |       | KX Green | <span style="color: green;">■</span> R-GRKXFVE0019 |         |



R-KITKXF-OEM-519

**OEM** original color - fluorescent color

| MODEL | CC      | YEAR        | NOTES                                    | COLOR                |  | CODE             | PRICE    |
|-------|---------|-------------|--|----------------------|--|------------------|----------|
| KX    | 65      | 2001 > 2023 | OEM 2020 > 2023<br>OEM 01 > 13 - 16 > 19 | OEM                  |  | R-KITKX0-VE0-508 | € 134,95 |
|       |         |             |  | OEM                  |  | R-KITKX0-OEM-508 |          |
|       |         |             |  | Black                |  | R-KITKX0-NR0-508 |          |
|       |         |             |  | White                |  | R-KITKX0-BN0-508 |          |
| KLX   | 110     | 2002 > 2009 |  | OEM                  |  | R-KITKLX-OEM-511 | € 134,95 |
|       |         |             |  | White                |  | R-KITKLX-BN0-511 |          |
| KX    | 85-100  | 1998 > 2013 | OEM 98 > 09 and 12-13                    | OEM                  |  | R-KITKX0-OEM-507 | € 134,95 |
|       |         |             |  | Black                |  | R-KITKX0-NR0-507 |          |
|       |         |             |  | White                |  | R-KITKX0-BN0-507 |          |
| KX    | 85-100  | 2014 > 2021 | OEM 2021<br>OEM 2020<br>OEM 2016 > 2019  | OEM                  |  | R-KITKX0-VE0-599 | € 134,95 |
|       |         |             |  | OEM                  |  | R-KITKX0-VE0-598 |          |
|       |         |             |  | OEM                  |  | R-KITKX0-OEM-598 |          |
|       |         |             |  | Black                |  | R-KITKX0-NR0-518 |          |
| KX    | 85-112  | 2022-2023   |  | White                |  | R-KITKX0-BN0-518 |          |
|       |         |             |  | OEM                  |  | R-KITKX0-VE0-585 | € 134,95 |
|       |         |             |  | Black                |  | R-KITKX0-NR0-585 |          |
| KX    | 125-250 | 1999 > 2002 |  | White                |  | R-KITKX0-BN0-585 |          |
|       |         |             |  | OEM                  |  | R-KITKX0-OEM-501 | € 134,95 |
| KX    | 125-250 | 2003 > 2008 |  | OEM                  |  | R-KITKX0-OEM-503 | € 134,95 |
| KXF   | 250     | 2004-2005   |  | Black                |  | R-KITKX0-NR0-503 |          |
|       |         |             |  | White                |  | R-KITKX0-BN0-503 |          |
|       |         |             |  | OEM                  |  | R-KITKXF-OEM-504 | € 134,95 |
| KXF   | 250     | 2006 > 2008 | OEM 2008                                 | Black                |  | R-KITKXF-NR0-504 |          |
|       |         |             |  | White                |  | R-KITKXF-BN0-504 |          |
|       |         |             |  | OEM                  |  | R-KITKXF-OEM-504 | € 134,95 |
| KXF   | 250     | 2006 > 2008 | OEM 2008                                 | OEM                  |  | R-KITKXF-NR0-505 | € 134,95 |
|       |         |             |  | Black                |  | R-KITKXF-NR0-505 |          |
|       |         |             |  | White                |  | R-KITKXF-BN0-505 |          |
|       |         |             |  | OEM                  |  | R-KITKXF-OEM-505 | € 134,95 |
| KXF   | 450     | 2006 > 2008 | OEM 2008                                 | Black                |  | R-KITKXF-NR0-506 |          |
|       |         |             |  | White                |  | R-KITKXF-BN0-506 |          |
|       |         |             |  | OEM                  |  | R-KITKXF-OEM-506 | € 134,95 |
| KXF   | 250     | 2009 > 2012 | OEM 2009 and 2012                        | OEM                  |  | R-KITKXF-NR0-509 | € 134,95 |
|       |         |             |  | Black                |  | R-KITKXF-NR0-509 |          |
|       |         |             |  | White                |  | R-KITKXF-BN0-509 |          |
| KXF   | 250     | 2013 > 2016 | OEM 2016                                 | OEM                  |  | R-KITKXF-OEM-596 | € 134,95 |
|       |         |             |  | Black                |  | R-KITKXF-NR0-516 | € 134,95 |
|       |         |             |  | White                |  | R-KITKXF-BN0-516 | € 134,95 |
|       |         |             |  | KX Green             |  | R-KITKXF-VE0-516 | € 134,95 |
| KXF   | 250     | 2013 > 2016 | Colour look USA                          | Neon Green           |  | R-KITKXF-VF0-516 | € 147,95 |
|       |         |             |  | KX Green/Black/White |  | R-KITKXF-US2-516 | € 147,95 |
| KXF   | 250     | 2017 > 2020 | OEM 2020<br>OEM 2019<br>OEM 2017-2018    | KX Green/Black       |  | R-KITKXF-VE0-519 | € 134,95 |
|       |         |             |  | OEM                  |  | R-KITKXF-OEM-529 | € 134,95 |
|       |         |             |  | OEM                  |  | R-KITKXF-OEM-519 | € 134,95 |
|       |         |             |  | White                |  | R-KITKXF-BN0-519 | € 134,95 |
| KXF   | 250     | 2021 > 2023 | 6 pcs<br>Limited Edition<br>OEM          | Black                |  | R-KITKXF-NR0-519 | € 134,95 |
|       |         |             |  | Neon Green           |  | R-KITKXF-VF0-519 | € 147,95 |
|       |         |             |  | Quantum Grey         |  | R-KITKXF-GR0-519 | € 134,95 |
|       |         |             |  | OEM                  |  | R-KITKXF-VE0-599 | € 134,95 |
|       |         |             |  | KX Green/White       |  | R-KITKXF-OEM-599 | € 134,95 |
|       |         |             |  | White                |  | R-KITKXF-BN0-599 | € 134,95 |
|       |         |             |  | Black                |  | R-KITKXF-NR0-599 | € 134,95 |
| KXF   | 250     | 2021 > 2023 | OEM                                      | Neon Green           |  | R-KITKXF-VF0-599 | € 134,95 |
|       |         |             |  | Quantum Grey         |  | R-KITKXF-GR0-599 | € 134,95 |
|       |         |             |  | OEM                  |  | R-KITKXF-VE0-699 | € 154,95 |
|       |         |             |  | OEM                  |  | R-KITKXF-NR0-699 | € 154,95 |

with fork protector

OEM original color - ☀ fluorescent color

| MODEL  | CC      | YEAR        | NOTES                                  | COLOR            |  |  |  |  |  |                  | CODE             | PRICE    |
|--|---------|-------------|--|------------------|--|--|--|--|--|------------------|------------------|----------|
| KXF<br>kit includes vented front fender                | 450     | 2009 > 2011 | OEM 2010-2011                          | OEM              |  |  |  |  |  |                  | R-KITKXF-OEM-510 | € 134,95 |
|  |         |             |  | Black            |  |  |  |  |  | R-KITKXF-NR0-510 |                  |          |
|  |         |             |  | White            |  |  |  |  |  | R-KITKXF-BN0-510 |                  |          |
| KXF<br>kit includes vented front fender                | 450     | 2012        |  | OEM              |  |  |  |  |  |                  | R-KITKXF-OEM-514 | € 134,95 |
|  |         |             |  | Black            |  |  |  |  |  | R-KITKXF-NR0-514 |                  |          |
|  |         |             |  | White            |  |  |  |  |  | R-KITKXF-BN0-514 |                  |          |
| KXF<br>kit includes vented front fender                | 450     | 2013 > 2015 |  | OEM              |  |  |  |  |  |                  | R-KITKXF-OEM-515 | € 134,95 |
|  |         |             |  | White            |  |  |  |  |  | R-KITKXF-BN0-515 |                  |          |
|  |         |             |  | Black            |  |  |  |  |  | R-KITKXF-NR0-515 |                  |          |
| KXF<br>kit includes vented front fender                | 450     | 2016 > 2018 | OEM                                    | OEM              |  |  |  |  |  |                  | R-KITKXF-OEM-517 | € 134,95 |
|  |         |             |  | White            |  |  |  |  |  |                  | R-KITKXF-BN0-517 | € 134,95 |
|  |         |             |  | Black            |  |  |  |  |  |                  | R-KITKXF-NR0-517 | € 134,95 |
|  |         |             |  | KX Green         |  |  |  |  |  |                  | R-KITKXF-VE0-517 | € 134,95 |
|  |         |             |  | ☀ Neon Green     |  |  |  |  |  |                  | R-KITKXF-VF0-517 | € 147,95 |
|  |         |             |  | ☀ KX Green-Black |  |  |  |  |  |                  | R-KITKXF-US4-517 | € 147,95 |
| KXF<br>USA version<br>kit includes vented front fender | 450     | 2016 > 2018 | OEM                                    | OEM              |  |  |  |  |  |                  | R-KITKXF-OEM-597 | € 134,95 |
|  |         |             |  | White            |  |  |  |  |  |                  | R-KITKXF-BN0-597 | € 134,95 |
|  |         |             |  | Black            |  |  |  |  |  |                  | R-KITKXF-NR0-597 | € 134,95 |
|  |         |             |  | KX Green         |  |  |  |  |  |                  | R-KITKXF-VE0-597 | € 134,95 |
|  |         |             |  | ☀ Neon Green     |  |  |  |  |  |                  | R-KITKXF-VF0-597 | € 147,95 |
|  |         |             |  | ☀ KX Green-Black |  |  |  |  |  |                  | R-KITKXF-US4-597 | € 147,95 |
| KXF<br>kit includes vented front fender                | 450     | 2019 > 2023 | OEM 2020 > 2023<br>OEM 2019            | OEM              |  |  |  |  |  |                  | R-KITKXF-VE0-599 | € 134,95 |
|  |         |             |  | KX Green/White   |  |  |  |  |  |                  | R-KITKXF-OEM-599 | € 134,95 |
|  |         |             |  | White            |  |  |  |  |  |                  | R-KITKXF-BN0-599 | € 134,95 |
|  |         |             |  | Black            |  |  |  |  |  |                  | R-KITKXF-NR0-599 | € 134,95 |
|  |         |             |  | ☀ Neon Green     |  |  |  |  |  |                  | R-KITKXF-VF0-599 | € 134,95 |
|  |         |             |  | Quantum Grey     |  |  |  |  |  |                  | R-KITKXF-GR0-599 | € 134,95 |
|  |         |             |  | OEM              |  |  |  |  |  |                  | R-KITKXF-VE0-699 | € 154,95 |
|  |         |             |  | KX Green/White   |  |  |  |  |  |                  | R-KITKXF-OEM-599 | € 134,95 |
| KX-XC<br>kit includes vented front fender              | 250-450 | 2021 > 2023 | with fork protector<br>OEM             | White            |  |  |  |  |  |                  | R-KITKXF-BN0-599 | € 134,95 |
|  |         |             |  | Black            |  |  |  |  |  |                  | R-KITKXF-NR0-599 | € 134,95 |
|  |         |             |  | ☀ Neon Green     |  |  |  |  |  |                  | R-KITKXF-VF0-599 | € 134,95 |
|  |         |             |  | Quantum Grey     |  |  |  |  |  |                  | R-KITKXF-GR0-599 | € 134,95 |
|  |         |             |  | OEM              |  |  |  |  |  |                  | R-KITKXF-VE0-699 | € 154,95 |
|  |         |             |  | KX Green/White   |  |  |  |  |  |                  | R-KITKXF-OEM-599 | € 134,95 |
| KLXR   | 450     | 2007 > 2016 | with fork protector<br>OEM 2013 > 2016 | OEM              |  |  |  |  |  |                  | R-KITKLX-OEM-497 | € 124,95 |
|  |         |             |  | OEM              |  |  |  |  |  |                  | R-KITKLX-NR0-407 |          |
|  |         |             |  | Black            |  |  |  |  |  |                  |                  |          |







## SUZUKI

**Front fender / Parafango anteriore >pag 142**

**Vented front fender / Parafango anteriore ventilato >pag 143**

**Rear fender / Parafango posteriore >pag 144**

**Radiator shrouds / Convogliatori aria radiatore >pag 145**

**Side panels / Tabelle laterali portanumero >pag 146**

**Front number plate / Tabella portanumero anteriore >pag 147**

**Gas tank cover / Copriserbatoio >pag 148**

**Oversize radiator louvers / Griglia radiatore maggiorate >pag 148**

**Fork protectors / Parasteli forcella >pag 149**

**Rear shock mud flap / Paraspruzzi monoammortizzatore >pag 149**

**Chain guide / Cruna guida catena >pag 150**

**Chain slider / Slitta scorricatena forcellone >pag 150**

**Replica plastics kit / Kit plastiche replica >pag 151**



R-PARMZBN0018



R-PARMZGI0018



R-PARMZNR0018

## AVAILABLE COLORS

RM Yellow
  Black
  White
  Neon Yellow

OEM original color - ☀️ fluorescent color

| MODEL | CC      | YEAR        | NOTES | COLOR       | CODE | PRICE         |         |
|-------|---------|-------------|-------|-------------|------|---------------|---------|
| RM    | 65      | 2003 > 2006 | OEM   | RM Yellow   |      | R-PAKX0GI0065 | € 25,95 |
|       |         |             |       | White       |      | R-PAKX0BN0065 |         |
|       |         |             |       | Black       |      | R-PAKX0NR0065 |         |
| DRZ   | 110     | 2003 > 2006 | OEM   | RM Yellow   |      | R-PAKX0GI0110 | € 25,95 |
|       |         |             |       | Black       |      | R-PAKX0NR0110 |         |
| RM    | 85      | 2000 > 2023 | OEM   | RM Yellow   |      | R-PARMOGI0085 | € 25,95 |
| RM    | 125-250 | 1989 > 2000 | OEM   | RM Yellow   |      | R-PARMOGI9600 | € 29,95 |
| RM    | 125-250 | 2001 > 2011 | OEM   | RM Yellow   |      | R-PARMOGI0103 | € 29,95 |
|       |         |             |       | White       |      | R-PARMOBN0103 |         |
|       |         |             |       | Black       |      | R-PARMONR0103 |         |
| RMZ   | 250     | 2004 > 2006 | OEM   | RM Yellow   |      | R-PAKX0GI0300 | € 29,95 |
|       |         |             |       | White       |      | R-PAKX0BN0300 |         |
|       |         |             |       | Black       |      | R-PAKX0NR0300 |         |
| RMZ   | 250     | 2007 > 2009 | OEM   | RM Yellow   |      | R-PARMOGI0103 | € 29,95 |
|       |         |             |       | White       |      | R-PARMOBN0103 |         |
|       |         |             |       | Black       |      | R-PARMONR0103 |         |
| RMZ   | 250     | 2010 > 2018 | OEM   | RM Yellow   |      | R-PARMZGI0008 | € 29,95 |
|       |         |             |       | Neon Yellow |      | R-PARMZGF0008 |         |
|       |         |             |       | White       |      | R-PARMZBN0008 |         |
|       |         |             |       | Black       |      | R-PARMZNR0008 |         |
| RMZ   | 250     | 2019 > 2023 | OEM   | White       |      | R-PARMZBN0018 | € 29,95 |
|       |         |             |       | RM Yellow   |      | R-PARMZGI0018 |         |
|       |         |             |       | Black       |      | R-PARMZNR0018 |         |
| RMZ   | 450     | 2005 > 2007 | OEM   | RM Yellow   |      | R-PARMOGI0103 | € 29,95 |
|       |         |             |       | White       |      | R-PARMOBN0103 |         |
|       |         |             |       | Black       |      | R-PARMONR0103 |         |
| RMZ   | 450     | 2008 > 2017 | OEM   | RM Yellow   |      | R-PARMZGI0008 | € 29,95 |
|       |         |             |       | Neon Yellow |      | R-PARMZGF0008 |         |
|       |         |             |       | White       |      | R-PARMZBN0008 |         |
| RMZ   | 450     | 2018 > 2023 | OEM   | Black       |      | R-PARMZNR0008 | € 29,95 |
|       |         |             |       | RM Yellow   |      | R-PARMZBN0018 |         |
|       |         |             |       | White       |      | R-PARMZGI0018 |         |
| RMXZ  | 450     | 2010 > 2019 | OEM   | Black       |      | R-PARMZNR0018 | € 29,95 |
|       |         |             |       | RM Yellow   |      | R-PARMZGI0008 |         |
|       |         |             |       | Neon Yellow |      | R-PARMZGF0008 |         |
|       |         |             |       | White       |      | R-PARMZBN0008 |         |
| DRZ   | 400     | 2000 > 2019 | OEM   | Black       |      | R-PARMZNR0008 | € 29,95 |
|       |         |             |       | RM Yellow   |      | R-PARMOGI0103 |         |
|       |         |             |       | White       |      | R-PARMOBN0103 |         |
|       |         |             |       | Black       |      | R-PARMONR0103 |         |

# SUZUKI VENTED FRONT FENDER / PARAFANGO ANTERIORE VENTILATO

ALL FENDERS ON THIS PAGE ARE VENTED AIRFLOW MODELS / PARAFANGO CON PRE-TAGLIO PER LA VENTILAZIONE



PARMZGI9918



PARMZBN9918



PARMZNR9918



PARMZGF9918

## AVAILABLE COLORS

RM Yellow
  Black
  White
  Neon Yellow

**OEM** original color - fluorescent color

| MODEL | CC  | YEAR        | NOTES | COLOR       | CODE          | PRICE   |
|-------|-----|-------------|-------|-------------|---------------|---------|
| RMZ   | 250 | 2019 > 2023 | OEM   | RM Yellow   | R-PARMZGI9918 | € 29,95 |
|       |     |             |       | White       | R-PARMZBN9918 |         |
|       |     |             |       | Neon Yellow | R-PARMZGF9918 |         |
|       |     |             |       | Black       | R-PARMZNR9918 |         |
| RMZ   | 450 | 2018 > 2023 | OEM   | RM Yellow   | R-PARMZGI9918 | € 29,95 |
|       |     |             |       | White       | R-PARMZBN9918 |         |
|       |     |             |       | Neon Yellow | R-PARMZGF9918 |         |
|       |     |             |       | Black       | R-PARMZNR9918 |         |

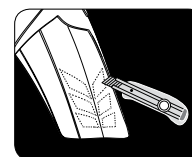



R-PPRMZGI0018



R-PPRMZBN0018



R-PPRMZNR0018



**NEON**

R-PPRMZGF0018

## AVAILABLE COLORS

- RM Yellow
- Black
- White
- Neon Yellow

**OEM** original color - fluorescent color

| MODEL | CC      | YEAR        | NOTES  | COLOR       |  | CODE          | PRICE   |
|-------|---------|-------------|--|-------------|--|---------------|---------|
| RM    | 65      | 2003 > 2006 | OEM  | RM Yellow   |  | R-PPKX0GI0065 | € 27,95 |
|       |         |             |  | White       |  | R-PPKX0BN0065 |         |
|       |         |             |  | Black       |  | R-PPKX0NR0065 |         |
| DRZ   | 110     | 2003 > 2006 | OEM  | RM Yellow   |  | R-PPKX0GI0065 | € 27,95 |
|       |         |             |  | White       |  | R-PPKX0BN0065 |         |
|       |         |             |  | Black       |  | R-PPKX0NR0065 |         |
| RM    | 85      | 2000 > 2023 | OEM 2000 > 2015 and 2017 > 2023<br>OEM 2016        | RM Yellow   |  | R-PPRM0GI0085 | € 29,95 |
|       |         |             |  | Black       |  | R-PPRM0NR0085 |         |
| RM    | 125-250 | 1996 > 2000 | OEM  | RM Yellow   |  | R-PPRM0GI9600 | € 29,95 |
| RM    | 125-250 | 2001 > 2011 | OEM  | RM Yellow   |  | R-PPRM0GI0103 | € 29,95 |
|       |         |             |  | White       |  | R-PPRM0BN0103 |         |
|       |         |             |  | Black       |  | R-PPRM0NR0103 |         |
| RMZ   | 250     | 2004 > 2006 | OEM  | RM Yellow   |  | R-PPRM0GI0004 | € 31,95 |
|       |         |             |  | White       |  | R-PPRM0BN0004 |         |
|       |         |             |  | Black       |  | R-PPRM0NR0004 |         |
| RMZ   | 250     | 2007 > 2009 | OEM  | RM Yellow   |  | R-PPRMZGI2507 | € 29,95 |
|       |         |             |  | White       |  | R-PPRMZBN2507 |         |
|       |         |             |  | Black       |  | R-PPRMZNR2507 |         |
| RMZ   | 250     | 2010 > 2018 | OEM 2010 > 2012 and 2017-2018<br>OEM 2013 > 2016   | RM Yellow   |  | R-PPRMZGI0010 | € 29,95 |
|       |         |             |  | Black       |  | R-PPRMZNR0010 |         |
|       |         |             |  | Neon Yellow |  | R-PPRMZGF0010 |         |
|       |         |             |  | White       |  | R-PPRMZBN0010 |         |
| RMZ   | 250     | 2019 > 2023 | OEM  | RM Yellow   |  | R-PPRMZGI0018 | € 29,95 |
|       |         |             |  | Black       |  | R-PPRMZNR0018 |         |
|       |         |             |  | Neon Yellow |  | R-PPRMZGF0018 |         |
|       |         |             |  | White       |  | R-PPRMZBN0018 |         |
| RMZ   | 450     | 2005 > 2007 | OEM  | RM Yellow   |  | R-PPRMZGI0005 | € 29,95 |
|       |         |             |  | White       |  | R-PPRMZBN0005 |         |
|       |         |             |  | Black       |  | R-PPRMZNR0005 |         |
| RMZ   | 450     | 2008 > 2017 | OEM 2008 > 2012 and 2017<br>OEM 2013 > 2016        | RM Yellow   |  | R-PPRMZGI0008 | € 29,95 |
|       |         |             |  | Black       |  | R-PPRMZNR0008 |         |
|       |         |             |  | Neon Yellow |  | R-PPRMZGF0008 |         |
|       |         |             |  | White       |  | R-PPRMZBN0008 |         |
| RMZ   | 450     | 2018 > 2023 | OEM  | RM Yellow   |  | R-PPRMZGI0018 | € 29,95 |
|       |         |             |  | Black       |  | R-PPRMZNR0018 |         |
|       |         |             |  | Neon Yellow |  | R-PPRMZGF0018 |         |
|       |         |             |  | White       |  | R-PPRMZBN0018 |         |
| RMXZ  | 450     | 2010 > 2019 | OEM 2010 > 2012 and 2017 > 2019<br>OEM 2013 > 2015 | RM Yellow   |  | R-PPRMXGI0010 | € 36,95 |
|       |         |             |  | Black       |  | R-PPRMXNR0010 |         |
|       |         |             |  | White       |  | R-PPRMXBN0010 |         |
| DRZ   | 400 E   | 2000 > 2009 | OEM  | RM Yellow   |  | R-PPDRZGI0000 | € 36,95 |
|       |         |             |  | Black       |  | R-PPDRZNR0000 |         |
|       |         |             |  | White       |  | R-PPDRZBN0000 |         |



R-CVRMZBN0018



R-CVRMZGINR18



R-CVRMZGI0018



**NEON**

R-CVRMZGFNR18



R-CVRMZNR0018

## AVAILABLE COLORS

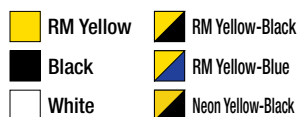

**OEM** original color - fluorescent color

| MODEL | CC      | YEAR        | NOTES   | COLOR             | CODE          | PRICE   |
|-------|---------|-------------|---|-------------------|---------------|---------|
| RM    | 65      | 2003 > 2006 | OEM   | RM Yellow         | R-CVKX0GI0065 | € 49,95 |
|       |         |             |   | Black             | R-CVKX0NR0065 |         |
|       |         |             |   | White             | R-CVKX0BN0065 |         |
| DRZ   | 110     | 2003 > 2006 | OEM   | RM Yellow         | R-CVKX0GI0065 | € 49,95 |
|       |         |             |   | Black             | R-CVKX0NR0065 |         |
|       |         |             |   | White             | R-CVKX0BN0065 |         |
| RM    | 85      | 2000 > 2023 | OEM - Single                                      | RM Yellow         | R-CVRM0GI0085 | € 31,95 |
| RM    | 125-250 | 1998 > 2000 | OEM   | RM Yellow         | R-CVRM0GI9600 | € 57,95 |
| RM    | 125-250 | 2001 > 2011 | OEM 2003 > 2011                                   | RM Yellow         | R-CVRM0GI0103 | € 57,95 |
|       |         |             |   | White             | R-CVRM0BN0103 |         |
|       |         |             |   | Black             | R-CVRM0NR0103 |         |
| RMZ   | 250     | 2004 > 2006 | OEM   | RM Yellow         | R-CVRM0GI0004 | € 57,95 |
|       |         |             |   | White             | R-CVRM0BN0004 |         |
| RMZ   | 250     | 2007 > 2009 | OEM   | RM Yellow         | R-CVRMZGI2507 | € 65,95 |
|       |         |             |   | White             | R-CVRMZBN2507 |         |
|       |         |             |   | Black             | R-CVRMZNR2507 |         |
| RMZ   | 250     | 2010 > 2018 | OEM - Bi-Color                                    | RM Yellow-Black   | R-CVRMZGINR10 | € 65,95 |
|       |         |             |   | Neon Yellow-Black | R-CVRMZGFNR10 |         |
|       |         |             |   | White             | R-CVRMZBN0010 |         |
|       |         |             |   | Black             | R-CVRMZNR0010 |         |
| RMZ   | 250     | 2019 > 2023 | OEM - Bi-Color                                    | RM Yellow-Black   | R-CVRMZGINR18 | € 65,95 |
|       |         |             |   | RM Yellow         | R-CVRMZGI0018 |         |
|       |         |             |   | Neon Yellow-Black | R-CVRMZGFNR18 |         |
|       |         |             |   | White             | R-CVRMZBN0018 |         |
|       |         |             |   | Black             | R-CVRMZNR0018 |         |
| RMZ   | 450     | 2005-2006   | OEM   | RM Yellow         | R-CVRMZGI0005 | € 57,95 |
| RMZ   | 450     | 2007        | OEM   | RM Yellow         | R-CVRMZGI0007 | € 62,95 |
|       |         |             |   | White             | R-CVRMZBN0007 |         |
|       |         |             |   | Black             | R-CVRMZNR0007 |         |
| RMZ   | 450     | 2008 > 2017 | OEM 2009 > 2017 - Bi-Color<br>OEM 2008 - Bi-Color | RM Yellow-Black   | R-CVRMZGINR08 | € 65,95 |
|       |         |             |   | RM Yellow-Blue    | R-CVRMZGIBL08 |         |
|       |         |             |   | Neon Yellow-Black | R-CVRMZGFNR08 |         |
|       |         |             |   | White             | R-CVRMZBN0008 |         |
|       |         |             |   | Black             | R-CVRMZNR0008 |         |
| RMZ   | 450     | 2018 > 2023 | OEM - Bi-Color                                    | RM Yellow-Black   | R-CVRMZGINR18 | € 65,95 |
|       |         |             |   | RM Yellow         | R-CVRMZGI0018 |         |
|       |         |             |   | Neon Yellow-Black | R-CVRMZGFNR18 |         |
|       |         |             |   | White             | R-CVRMZBN0018 |         |
|       |         |             |   | Black             | R-CVRMZNR0018 |         |
| RMXZ  | 450     | 2010 > 2019 | OEM - Bi-Color                                    | RM Yellow-Black   | R-CVRMZGINR08 | € 65,95 |
|       |         |             |   | Neon Yellow-Black | R-CVRMZGFNR08 |         |
|       |         |             |   | White             | R-CVRMZBN0008 |         |
|       |         |             |   | Black             | R-CVRMZNR0008 |         |
| DRZ   | 400 S-E | 2000 > 2019 | OEM   | RM Yellow         | R-CVDRZGI0000 | € 57,95 |
|       |         |             |   | Black             | R-CVDRZNR0000 |         |
|       |         |             |   | White             | R-CVDRZBN0000 |         |



R-FIRMZBN0018



R-FIRMZGI0018



R-FIRMZNR0018



R-FIRMZGF0018

AVAILABLE COLORS



OEM original color - ☀️ fluorescent color

| MODEL | CC      | YEAR        | NOTES  | COLOR           | CODE | PRICE                 |
|-------|---------|-------------|--|-----------------|------|-----------------------|
| RM    | 65      | 2003 > 2006 | OEM  | White           |      | R-FIKX0BN0065 € 49,95 |
|       |         |             |  | Black           |      | R-FIKX0NR0065         |
| RM    | 80      | 1996 > 2001 | OEM  | RM Yellow       |      | € 49,95               |
| DRZ   | 110     | 2003 > 2006 | OEM  | White           |      | R-FIKX0BN0065 € 49,95 |
|       |         |             |  | Black           |      | R-FIKX0NR0065         |
| RM    | 85      | 2000 > 2023 | OEM 2000 > 2015 and 2018 > 2023<br>OEM 2017<br>OEM 2016        | RM Yellow       |      | R-FIRM0GI0085 € 49,95 |
|       |         |             |  | Black           |      | R-FIRM0NR0085         |
|       |         |             |  | White           |      | R-FIRM0BN0085         |
|       |         |             |  | White           |      | R-FIRM0BN9600 € 57,95 |
| RM    | 125-250 | 1996 > 2000 | OEM  | White           |      | R-FIRM0BN0103 € 57,95 |
| RM    | 125-250 | 2001 > 2011 | OEM  | White           |      | R-FIRM0NR0103         |
|       |         |             |  | Black           |      | R-FIRM0NR0103         |
| RMZ   | 250     | 2004 > 2006 | OEM  | White           |      | R-FIRM0BN0004 € 57,95 |
| RMZ   | 250     | 2007 > 2009 | OEM  | White           |      | R-FIRMZBN2507 € 65,95 |
|       |         |             |  | Black           |      | R-FIRMZNR2507         |
| RMZ   | 250     | 2010 > 2018 | OEM 2010 > 2012 and 2017<br>OEM 2014 > 2016<br>OEM 2013        | Black-RM Yellow |      | R-FIRMZNRGI10 € 65,95 |
|       |         |             |  | RM Yellow-Black |      | R-FIRMZGINR10         |
|       |         |             |  | White-Black     |      | R-FIRMZBNNR10         |
|       |         |             |  | Neon Yellow     |      | R-FIRMZGF0010         |
|       |         |             |  | Black           |      | R-FIRMZNR0010         |
|       |         |             |  | White           |      | R-FIRMZBN0010         |
| RMZ   | 250     | 2019 > 2023 | OEM 2018   | RM Yellow       |      | R-FIRMZGI0018 € 57,95 |
|       |         |             |  | White           |      | R-FIRMZBN0018         |
|       |         |             |  | Neon Yellow     |      | R-FIRMZGF0018         |
|       |         |             |  | Black           |      | R-FIRMZNR0018         |
|       |         |             |  | Black           |      | R-FIRMZNR0018         |
| RMZ   | 450     | 2005 > 2007 | OEM  | RM Yellow       |      | R-FIRMZGI0005 € 57,95 |
|       |         |             |  | White           |      | R-FIRMZBN0005         |
|       |         |             |  | Black           |      | R-FIRMZNR0005         |
|       |         |             |  | Black           |      | R-FIRMZNR0005         |
| RMZ   | 450     | 2008 > 2017 | OEM 2017<br>OEM 2014 > 2016                                    | RM Yellow       |      | € 57,95               |
|       |         |             |  | Black           |      | R-FIRMZNR0008         |
|       |         |             |  | Neon Yellow     |      | R-FIRMZGF0008         |
|       |         |             |  | White           |      | R-FIRMZBN0008         |
|       |         |             |  | White           |      | R-FIRMZBN0008         |
| RMZ   | 450     | 2018 > 2023 | OEM 2008 > 2013  | RM Yellow       |      | R-FIRMZGI0018 € 57,95 |
|       |         |             |  | White           |      | R-FIRMZBN0018         |
|       |         |             |  | Neon Yellow     |      | R-FIRMZGF0018         |
|       |         |             |  | Black           |      | R-FIRMZNR0018         |
| RMXZ  | 450     | 2010 > 2019 | OEM 2010 > 2012 and 2018 > 2019<br>OEM 2013 > 2016<br>OEM 2017 | RM Yellow       |      | € 65,95               |
|       |         |             |  | White           |      | R-FIRMXBN0010         |
|       |         |             |  | Black           |      | R-FIRMXNR0010         |
|       |         |             |  | Black           |      | R-FIRMXNR0010         |
| DRZ   | 400 E   | 2000 > 2009 | OEM  | White           |      | R-FIDRZBN0000 € 57,95 |
|       |         |             |  | Black           |      | R-FIDRZNR0000         |



**FACTORY EDITION**

**NEON**



R-TBRMZGF0008



R-TBRMZGI0016



R-TBRMZR0018

**AVAILABLE COLORS**

- RM Yellow
- Black
- White
- Neon Yellow

**OEM** original color - fluorescent color

| MODEL | CC      | YEAR        | NOTES   | COLOR       |               | CODE          | PRICE   |
|-------|---------|-------------|---|-------------|---------------|---------------|---------|
| RM    | 65      | 2003 > 2006 | OEM   | White       |               | R-TBKX0BN0065 | € 23,95 |
|       |         |             |   | Black       |               | R-TBKX0NR0065 |         |
| DRZ   | 110     | 2003 > 2006 | OEM   | White       |               | R-TBKX0BN0065 | € 23,95 |
|       |         |             |   | Black       |               | R-TBKX0NR0065 |         |
| RM    | 85      | 2000 > 2023 | OEM 2000 > 2015 and 2018 > 2022<br>OEM 2016-2017            | Yellow      |               | R-TBRM0GI0085 | € 23,95 |
|       |         |             |   | White       |               | R-TBRM0BN0085 |         |
| RM    | 125-250 | 1999-2000   | OEM   | White       |               | R-TBRM0BN9600 | € 28,95 |
| RM    | 125-250 | 2001 > 2011 | OEM 2010 > 2011<br>OEM 2003 > 2009                          | RM Yellow   |               | R-TBRM0GI0103 | € 28,95 |
|       |         |             |   | White       |               | R-TBRM0BN0103 |         |
|       |         |             |   | Black       |               | R-TBRM0NR0103 |         |
| RMZ   | 250     | 2004 > 2006 | OEM   | White       |               | R-TBKX0BN0300 | € 28,95 |
|       |         |             |   | Black       |               | R-TBKX0NR0300 |         |
| RMZ   | 250     | 2007 > 2009 | OEM   | RM Yellow   |               | R-TBRM0GI0103 | € 28,95 |
|       |         |             |   | White       |               | R-TBRM0BN0103 |         |
|       |         |             |   | Black       |               | R-TBRM0NR0103 |         |
| RMZ   | 250     | 2010 > 2018 | OEM 2010 and 2013 > 2018<br>OEM 2011-2012                   | RM Yellow   |               | R-TBRMZGI0008 | € 28,95 |
|       |         |             |   | Black       |               | R-TBRMZR0008  | € 28,95 |
|       |         |             |   | Neon Yellow |               | R-TBRMZGF0008 | € 28,95 |
|       |         |             |   | White       |               | R-TBRMZBN0008 | € 28,95 |
|       |         |             |   | RM Yellow   |               | R-TBRMZGI0016 | € 38,95 |
|       |         |             | Neon Yellow   |             | R-TBRMZGF0016 | € 38,95       |         |
|       |         |             | White   |             | R-TBRMZBN0016 | € 38,95       |         |
|       |         |             | Black   |             | R-TBRMZR0016  | € 38,95       |         |
| RMZ   | 250     | 2019 > 2023 | OEM   | RM Yellow   |               | R-TBRMZGI0018 | € 28,95 |
|       |         |             |   | Neon Yellow |               | R-TBRMZGF0018 |         |
|       |         |             |   | White       |               | R-TBRMZBN0018 |         |
|       |         |             |   | Black       |               | R-TBRMZR0018  |         |
| RMZ   | 450     | 2005 > 2007 | OEM   | RM Yellow   |               | R-TBRM0GI0103 | € 28,95 |
|       |         |             |   | White       |               | R-TBRM0BN0103 |         |
|       |         |             |   | Black       |               | R-TBRM0NR0103 |         |
| RMZ   | 450     | 2008 > 2017 | OEM 2009-2010 and 2013 > 2017<br>OEM 2008 and 2011 and 2012 | RM Yellow   |               | R-TBRMZGI0008 | € 28,95 |
|       |         |             |   | White       |               | R-TBRMZBN0008 | € 28,95 |
|       |         |             |   | Neon Yellow |               | R-TBRMZGF0008 | € 28,95 |
|       |         |             |   | Black       |               | R-TBRMZR0008  | € 28,95 |
|       |         |             |   | RM Yellow   |               | R-TBRMZGI0016 | € 38,95 |
|       |         |             |   | Neon Yellow |               | R-TBRMZGF0016 | € 38,95 |
|       |         |             | White   |             | R-TBRMZBN0016 | € 38,95       |         |
|       |         |             | Black   |             | R-TBRMZR0016  | € 38,95       |         |
| RMZ   | 450     | 2018 > 2023 | OEM   | RM Yellow   |               | R-TBRMZGI0018 | € 28,95 |
|       |         |             |   | Neon Yellow |               | R-TBRMZGF0018 |         |
|       |         |             |   | White       |               | R-TBRMZBN0018 |         |
|       |         |             | Black   |             | R-TBRMZR0018  |               |         |

**FACTORY EDITION**

**FACTORY EDITION**

# SUZUKI GAS TANK COVER / COPRISERBATOIO



R-COVSRRMZBL1



R-COVSRRMZBN1



R-COVSRRMZNR1



R-COVSRRMZGF1



## AVAILABLE COLORS

- Blue
- Black
- White
- Neon Yellow

**OEM** original color - fluorescent color

| MODEL | CC  | YEAR        | NOTES | COLOR       | CODE   | PRICE   |
|-------|-----|-------------|-------|-------------|--|---------|
| RMZ   | 250 | 2019 > 2023 | OEM   | Blue        | <span style="display: inline-block; width: 15px; height: 15px; background-color: blue; border: 1px solid black;"></span> R-COVSRRMZBL1   | € 38,95 |
|       |     |             |       | White       | <span style="display: inline-block; width: 15px; height: 15px; background-color: white; border: 1px solid black;"></span> R-COVSRRMZBN1  |         |
|       |     |             |       | Neon Yellow | <span style="display: inline-block; width: 15px; height: 15px; background-color: yellow; border: 1px solid black;"></span> R-COVSRRMZGF1 |         |
|       |     |             |       | Black       | <span style="display: inline-block; width: 15px; height: 15px; background-color: black; border: 1px solid black;"></span> R-COVSRRMZNR1  |         |
| RMZ   | 450 | 2018 > 2023 | OEM   | Blue        | <span style="display: inline-block; width: 15px; height: 15px; background-color: blue; border: 1px solid black;"></span> R-COVSRRMZBL1   | € 38,95 |
|       |     |             |       | White       | <span style="display: inline-block; width: 15px; height: 15px; background-color: white; border: 1px solid black;"></span> R-COVSRRMZBN1  |         |
|       |     |             |       | Neon Yellow | <span style="display: inline-block; width: 15px; height: 15px; background-color: yellow; border: 1px solid black;"></span> R-COVSRRMZGF1 |         |
|       |     |             |       | Black       | <span style="display: inline-block; width: 15px; height: 15px; background-color: black; border: 1px solid black;"></span> R-COVSRRMZNR1  |         |

# SUZUKI RADIATOR LOUVERS / GRIGLIE RADIATORE



R-GRRMZGF0019



R-GRRMZGI0019



R-GRRMZNR0019

## AVAILABLE COLORS

- RM Yellow
- Black
- Neon Yellow

**OEM** original color - fluorescent color

| MODEL | CC  | YEAR        | NOTES | COLOR       | CODE   | PRICE   |
|-------|-----|-------------|-------|-------------|--|---------|
| RMZ   | 250 | 2019 > 2023 | OEM   | Black       | <span style="display: inline-block; width: 15px; height: 15px; background-color: black; border: 1px solid black;"></span> R-GRRMZNR0019  | € 36,95 |
|       |     |             |       | RM Yellow   | <span style="display: inline-block; width: 15px; height: 15px; background-color: yellow; border: 1px solid black;"></span> R-GRRMZGI0019 |         |
|       |     |             |       | Neon Yellow | <span style="display: inline-block; width: 15px; height: 15px; background-color: yellow; border: 1px solid black;"></span> R-GRRMZGF0019 |         |
| RMZ   | 450 | 2018 > 2023 | OEM   | Black       | <span style="display: inline-block; width: 15px; height: 15px; background-color: black; border: 1px solid black;"></span> R-GRRMZNR0018  | € 36,95 |
|       |     |             |       | RM Yellow   | <span style="display: inline-block; width: 15px; height: 15px; background-color: yellow; border: 1px solid black;"></span> R-GRRMZGI0018 |         |
|       |     |             |       | Neon Yellow | <span style="display: inline-block; width: 15px; height: 15px; background-color: yellow; border: 1px solid black;"></span> R-GRRMZGF0018 |         |

# SUZUKI FORK PROTECTORS / PARASTELI FORCELLA

 NEON



R-PSRM0BN0007



R-PSRM0GI0007























R-PSRM0NR0007

R-PSRM0GF0007

## AVAILABLE COLORS



 OEM original color -  fluorescent color

| MODEL  | CC      | YEAR        | NOTES  | COLOR       |   | CODE          | PRICE   |
|--------|---------|-------------|--|-------------|---|---------------|---------|
| RM     | 85      | 2000 > 2023 | OEM 2000 > 2015 and 2018 > 2019<br>OEM 2016-2017 and 2020 > 2023   | White       |    | R-PSRM0BN0085 | € 31,95 |
|        |         |             |  | Black       |    | R-PSRM0NR0085 |         |
| RM     | 125-250 | 1999 > 2003 | OEM  | White       |    | R-PSRM0BN0003 | € 34,95 |
| RM     | 125-250 | 2004 > 2006 | OEM  | White       |    | R-PSRM0BN0004 | € 34,95 |
| RM     | 125-250 | 2007 > 2011 | OEM 2007 > 2011  | RM Yellow   |    | R-PSRM0GI0007 | € 34,95 |
|        |         |             |  | White       |    | R-PSRM0BN0007 |         |
|        |         |             |  | Black       |    | R-PSRM0NR0007 |         |
| RMZ    | 250     | 2004 > 2006 | OEM  | Neon Yellow |     | R-PSRM0GF0007 | € 34,95 |
|        |         |             |  | White       |    | R-PSKX0BN0004 |         |
|        |         |             |  | Black       |    | R-PSKX0NR0004 |         |
| RMZ    | 450     | 2005-2006   | OEM  | White       |    | R-PSRM0BN0004 | € 34,95 |
| RM/RMZ | 250-450 | 2007 > 2023 | OEM 2007 > 2011<br>OEM 2012 > 2023   | RM Yellow   |    | R-PSRM0GI0007 | € 34,95 |
|        |         |             |  | White       |    | R-PSRM0BN0007 |         |
| RMXZ   | 450     | 2010 > 2019 | Without tachimeter cable guide<br>OEM 2010 > 2012<br>Without tachimeter cable guide<br>OEM 2013 > 2019<br>Without tachimeter cable guide<br>Without tachimeter cable guide | Black       |    | R-PSRM0NR0007 | € 34,95 |
|        |         |             |  | Neon Yellow |   | R-PSRM0GF0007 |         |
|        |         |             |  | RM Yellow   |    | R-PSRM0GI0007 |         |
|        |         |             |  | White       |    | R-PSRM0BN0007 |         |
|        |         |             |  | Black       |    | R-PSRM0NR0007 |         |
|        |         |             |  | Neon Yellow |   | R-PSRM0GF0007 |         |

# SUZUKI REAR SHOCK MUD FLAP / PARASPRUZZI MONOAMMORTIZZATORE



R-PSPRM0GI000











R-PSPRM0NR000

## AVAILABLE COLORS



 OEM original color

| MODEL | CC      | YEAR        | NOTES | COLOR     |   | CODE          | PRICE   |
|-------|---------|-------------|-------|-----------|---|---------------|---------|
| RM    | 125-250 | 1996 > 2011 | OEM   | Black     |  | R-PSPRM0NR000 | € 18,95 |
|       |         |             |       | RM Yellow |  | R-PSPRM0GI000 |         |
| RMZ   | 250     | 2004 > 2006 | OEM   | Black     |  | R-PSPKXFNR006 | € 18,95 |
| RMZ   | 250     | 2007 > 2023 | OEM   | Black     |  | R-PSPRM0NR000 | € 18,95 |
| RMZ   | 450     | 2005 > 2023 | OEM   | RM Yellow |  | R-PSPRM0GI000 | € 18,95 |
|       |         |             |       | Black     |  | R-PSPRM0NR000 |         |
| RMXZ  | 450     | 2010 > 2019 | OEM   | RM Yellow |  | R-PSPRM0GI000 | € 18,95 |
|       |         |             |       | Black     |  | R-PSPRM0NR000 |         |
|       |         |             |       | RM Yellow |  | R-PSPRM0GI000 |         |



R-CRURMZGI018



R-CRURMZNR018

## AVAILABLE COLORS

RM Yellow Black Red

**OEM** original color

| MODEL | CC      | YEAR        | NOTES | COLOR     | CODE          | PRICE   |
|-------|---------|-------------|-------|-----------|---------------|---------|
| RM    | 125-250 | 1999 > 2004 | OEM   | Black     | R-CRURMONR001 | € 25,95 |
| RM    | 125-250 | 2005 > 2011 | OEM   | Black     | R-CRURMONR007 | € 25,95 |
|       |         |             |       | RM Yellow | R-CRURMOGI007 |         |
|       |         |             |       | Red       | R-CRURMORS007 |         |
| RMZ   | 250     | 2004 > 2006 | OEM   | Black     | R-CRUKXFNR004 | € 25,95 |
| RMZ   | 250     | 2007 > 2018 | OEM   | Black     | R-CRURMONR007 | € 25,95 |
|       |         |             |       | RM Yellow | R-CRURMOGI007 |         |
|       |         |             |       | Red       | R-CRURMORS007 |         |
| RMZ   | 250     | 2019 > 2023 | OEM   | Black     | R-CRURMZNR018 | € 25,95 |
|       |         |             |       | RM Yellow | R-CRURMZGI018 |         |
| RMZ   | 450     | 2005 > 2017 | OEM   | Black     | R-CRURMONR007 | € 25,95 |
|       |         |             |       | RM Yellow | R-CRURMOGI007 |         |
|       |         |             |       | Red       | R-CRURMORS007 |         |
| RMZ   | 450     | 2018 > 2023 | OEM   | Black     | R-CRURMZNR018 | € 25,95 |
|       |         |             |       | RM Yellow | R-CRURMZGI018 |         |
| RMXZ  | 450     | 2010 > 2019 | OEM   | Black     | R-CRURMONR007 | € 25,95 |
|       |         |             |       | RM Yellow | R-CRURMOGI007 |         |
|       |         |             |       | Red       | R-CRURMORS007 |         |



MONOBLOCK R2.0 WORX CHAIN GUIDE - PAG. 254



R-SLIRMZGI018



R-SLIRMZNR018

## AVAILABLE COLORS

RM Yellow Black Red

**OEM** original color

| MODEL | CC      | YEAR        | NOTES | COLOR     | CODE          | PRICE   |
|-------|---------|-------------|-------|-----------|---------------|---------|
| RM    | 125-250 | 2001 > 2011 | OEM   | Black     | R-SLIRMONR001 | € 25,95 |
|       |         |             |       | RM Yellow | R-SLIRMOGI001 |         |
| RMZ   | 250     | 2004 > 2006 | OEM   | Black     | R-SLIKXFNR004 | € 25,95 |
| RMZ   | 250     | 2007 > 2009 | OEM   | Black     | R-SLIRMONR001 | € 25,95 |
|       |         |             |       | RM Yellow | R-SLIRMOGI001 |         |
| RMZ   | 250     | 2010 > 2018 | OEM   | Black     | R-SLIRMZNR007 | € 25,95 |
|       |         |             |       | RM Yellow | R-SLIRMZGI007 |         |
|       |         |             |       | Red       | R-SLIRMZRS007 |         |
| RMZ   | 250     | 2019 > 2023 | OEM   | Black     | R-SLIRMZNR018 | € 25,95 |
|       |         |             |       | RM Yellow | R-SLIRMZGI018 |         |
| RMZ   | 450     | 2005-2006   | OEM   | Black     | R-SLIRMONR001 | € 25,95 |
|       |         |             |       | RM Yellow | R-SLIRMOGI001 |         |
| RMZ   | 450     | 2007        | OEM   | Black     | R-SLIRMZNR007 | € 25,95 |
|       |         |             |       | RM Yellow | R-SLIRMZGI007 |         |
|       |         |             |       | Red       | R-SLIRMZRS007 |         |
| RMZ   | 450     | 2008-2009   | OEM   | Black     | R-SLIRMONR001 | € 25,95 |
|       |         |             |       | RM Yellow | R-SLIRMOGI001 |         |
| RMZ   | 450     | 2010 > 2017 | OEM   | Black     | R-SLIRMZNR007 | € 25,95 |
|       |         |             |       | RM Yellow | R-SLIRMZGI007 |         |
|       |         |             |       | Red       | R-SLIRMZRS007 |         |
| RMZ   | 450     | 2018 > 2023 | OEM   | Black     | R-SLIRMZNR018 | € 25,95 |
|       |         |             |       | RM Yellow | R-SLIRMZGI018 |         |
| RMXZ  | 450     | 2010 > 2019 | OEM   | Black     | R-SLIRMONR001 | € 25,95 |
|       |         |             |       | RM Yellow | R-SLIRMOGI001 |         |



R-KITRMZ-OEM-518

**OEM** original color - ☀️ fluorescent color

| MODEL                                   | CC      | YEAR        | NOTES  | COLOR          |     |    |    |    |    |    | CODE             | PRICE    |
|---|---------|-------------|--|----------------|-----|----|----|----|----|----|------------------|----------|
| RM                                      | 65      | 2003 > 2008 |  | OEM            | ☀️  | ☀️ | ☀️ | ☀️ | ☀️ | ☀️ | R-KITRM0-OEM-509 | € 134,95 |
| RM                                      | 85      | 2000 > 2023 | OEM 2000 > 2015 and 2018 > 2023<br>OEM 2017<br>OEM 2016      | OEM            | ☀️  | ☀️ | ☀️ | ☀️ | ☀️ | ☀️ | R-KITRM0-OEM-510 | € 134,95 |
|   |         |             |  | OEM            | ☀️  | ☀️ | ☀️ | ☀️ | ☀️ | ☀️ | R-KITRM0-OEM-599 |          |
|   |         |             |  | OEM            | ☀️  | ☀️ | ☀️ | ☀️ | ☀️ | ☀️ | R-KITRM0-OEM-590 |          |
| RM                                      | 125-250 | 1998 > 2000 |  | OEM            | ☀️  | ☀️ | ☀️ | ☀️ | ☀️ | ☀️ | R-KITRM0-OEM-501 | € 134,95 |
| RM                                      | 125-250 | 2001 > 2011 | OEM 2010-2011  | OEM            | ☀️  | ☀️ | ☀️ | ☀️ | ☀️ | ☀️ | R-KITRM0-OEM-502 | € 134,95 |
|   |         |             |  | Black          | ☀️  | ☀️ | ☀️ | ☀️ | ☀️ | ☀️ | R-KITRM0-NR0-502 |          |
|   |         |             |  | White          | ☀️  | ☀️ | ☀️ | ☀️ | ☀️ | ☀️ | R-KITRM0-BN0-502 |          |
| RMZ                                     | 250     | 2004 > 2006 |  | OEM            | ☀️  | ☀️ | ☀️ | ☀️ | ☀️ | ☀️ | R-KITRMZ-OEM-504 | € 134,95 |
|   |         |             |  | White          | ☀️  | ☀️ | ☀️ | ☀️ | ☀️ | ☀️ | R-KITRMZ-BN0-504 |          |
| RMZ                                     | 250     | 2007 > 2009 |  | OEM            | ☀️  | ☀️ | ☀️ | ☀️ | ☀️ | ☀️ | R-KITRMZ-OEM-507 | € 134,95 |
|   |         |             |  | Black          | ☀️  | ☀️ | ☀️ | ☀️ | ☀️ | ☀️ | R-KITRMZ-NR0-507 |          |
|   |         |             |  | White          | ☀️  | ☀️ | ☀️ | ☀️ | ☀️ | ☀️ | R-KITRMZ-BN0-507 |          |
| RMZ                                     | 250     | 2010 > 2018 | OEM 2018<br>OEM 2017<br>OEM 2014-2016                        | OEM            | ☀️  | ☀️ | ☀️ | ☀️ | ☀️ | ☀️ | R-KITRMZ-OEM-592 | € 134,95 |
|   |         |             |  | OEM            | ☀️  | ☀️ | ☀️ | ☀️ | ☀️ | ☀️ | R-KITRMZ-OEM-591 |          |
|   |         |             |  | OEM            | ☀️  | ☀️ | ☀️ | ☀️ | ☀️ | ☀️ | R-KITRMZ-OEM-511 |          |
|   |         |             |  | Neon Yellow ☀️ | ☀️  | ☀️ | ☀️ | ☀️ | ☀️ | ☀️ | R-KITRMZ-GF0-511 |          |
|   |         |             |  | Black          | ☀️  | ☀️ | ☀️ | ☀️ | ☀️ | ☀️ | R-KITRMZ-NR0-511 |          |
|   |         |             |  | White          | ☀️  | ☀️ | ☀️ | ☀️ | ☀️ | ☀️ | R-KITRMZ-BN0-511 |          |
| RMZ                                     | 250     | 2019 > 2023 | OEM  | OEM            | ☀️  | ☀️ | ☀️ | ☀️ | ☀️ | ☀️ | R-KITRMZ-OEM-518 | € 134,95 |
| <b>kit includes vented front fender</b> |         |             |  | White          | ☀️  | ☀️ | ☀️ | ☀️ | ☀️ | ☀️ | R-KITRMZ-BN0-518 | € 134,95 |
|   |         |             |  | Neon Yellow ☀️ | ☀️  | ☀️ | ☀️ | ☀️ | ☀️ | ☀️ | R-KITRMZ-GF0-518 | € 134,95 |
|   |         |             |  | RM Yellow      | ☀️  | ☀️ | ☀️ | ☀️ | ☀️ | ☀️ | R-KITRMZ-GI0-518 | € 134,95 |
|   |         |             |  | Black          | ☀️  | ☀️ | ☀️ | ☀️ | ☀️ | ☀️ | R-KITRMZ-NR0-518 | € 134,95 |
|   |         |             | with fork protector  |                | OEM | ☀️ | ☀️ | ☀️ | ☀️ | ☀️ | R-KITRMZ-OEM-618 | € 154,95 |
| RMZ                                     | 450     | 2005-2006   |  | OEM            | ☀️  | ☀️ | ☀️ | ☀️ | ☀️ | ☀️ | R-KITRMZ-OEM-505 | € 134,95 |
| RMZ                                     | 450     | 2007        |  | OEM            | ☀️  | ☀️ | ☀️ | ☀️ | ☀️ | ☀️ | R-KITRMZ-OEM-506 | € 134,95 |
|   |         |             |  | Black          | ☀️  | ☀️ | ☀️ | ☀️ | ☀️ | ☀️ | R-KITRMZ-NR0-506 |          |
|   |         |             |  | White          | ☀️  | ☀️ | ☀️ | ☀️ | ☀️ | ☀️ | R-KITRMZ-BN0-506 |          |
| RMZ                                     | 450     | 2008 > 2017 | OEM 2017<br>OEM 2014 > 16 - Yellow/Black shrouds             | OEM            | ☀️  | ☀️ | ☀️ | ☀️ | ☀️ | ☀️ | R-KITRMZ-OEM-598 | € 134,95 |
|   |         |             |  | OEM            | ☀️  | ☀️ | ☀️ | ☀️ | ☀️ | ☀️ | R-KITRMZ-OEM-508 |          |
|   |         |             |  | Neon Yellow ☀️ | ☀️  | ☀️ | ☀️ | ☀️ | ☀️ | ☀️ | R-KITRMZ-GF0-508 |          |
|   |         |             |  | Black          | ☀️  | ☀️ | ☀️ | ☀️ | ☀️ | ☀️ | R-KITRMZ-NR0-508 |          |
|   |         |             |  | White          | ☀️  | ☀️ | ☀️ | ☀️ | ☀️ | ☀️ | R-KITRMZ-BN0-508 |          |
| RMZ                                     | 450     | 2018 > 2023 | OEM  | OEM            | ☀️  | ☀️ | ☀️ | ☀️ | ☀️ | ☀️ | R-KITRMZ-OEM-518 | € 134,95 |
| <b>kit includes vented front fender</b> |         |             |  | White          | ☀️  | ☀️ | ☀️ | ☀️ | ☀️ | ☀️ | R-KITRMZ-BN0-518 | € 134,95 |
|   |         |             |  | Neon Yellow ☀️ | ☀️  | ☀️ | ☀️ | ☀️ | ☀️ | ☀️ | R-KITRMZ-GF0-518 | € 134,95 |
|   |         |             |  | RM Yellow      | ☀️  | ☀️ | ☀️ | ☀️ | ☀️ | ☀️ | R-KITRMZ-GI0-518 | € 134,95 |
|   |         |             |  | Black          | ☀️  | ☀️ | ☀️ | ☀️ | ☀️ | ☀️ | R-KITRMZ-NR0-518 | € 134,95 |
|   |         |             | with fork protector  |                | OEM | ☀️ | ☀️ | ☀️ | ☀️ | ☀️ | R-KITRMZ-OEM-618 | € 154,95 |
| RMXZ                                    | 450     | 2010 > 2019 | OEM 2017<br>OEM 2013 > 2016<br>OEM 2010 > 2012 and 2018-2019 | OEM            | ☀️  | ☀️ | ☀️ | ☀️ | ☀️ | ☀️ | R-KITRMX-OEM-492 | € 124,95 |
|   |         |             |  | OEM            | ☀️  | ☀️ | ☀️ | ☀️ | ☀️ | ☀️ | R-KITRMX-OEM-491 |          |
|   |         |             |  | OEM            | ☀️  | ☀️ | ☀️ | ☀️ | ☀️ | ☀️ | R-KITRMX-OEM-411 |          |
|   |         |             |  | Black          | ☀️  | ☀️ | ☀️ | ☀️ | ☀️ | ☀️ | R-KITRMX-NR0-411 |          |
|   |         |             |  | White          | ☀️  | ☀️ | ☀️ | ☀️ | ☀️ | ☀️ | R-KITRMX-BN0-411 |          |
| DRZ                                     | 400 E   | 2000 > 2009 |  | OEM            | ☀️  | ☀️ | ☀️ | ☀️ | ☀️ | ☀️ | R-KITDRZ-OEM-411 | € 124,95 |
|   |         |             |  | Black          | ☀️  | ☀️ | ☀️ | ☀️ | ☀️ | ☀️ | R-KITDRZ-NR0-411 |          |
|   |         |             |  | White          | ☀️  | ☀️ | ☀️ | ☀️ | ☀️ | ☀️ | R-KITDRZ-BN0-411 |          |



## **KTM**

**Front fender** / Parafango anteriore >**pag 154**

**Vented front fender** / Parafango anteriore ventilato >**pag 156**

**Rear fender** / Parafango posteriore >**pag 157**

**Radiator shrouds** / Convogliatori aria radiatore >**pag 160**

**Side panels** / Tabelle laterali portanumero >**pag 164**

**Air box cover** / Coperchi laterali cassa filtro >**pag 167**

**Oversize radiator louvers** / Griglie radiatore maggiorate >**pag 172**

**Front headlight** / Mascherina portafaro >**pag 174**

**Front number plate** / Tabella portanumero anteriore >**pag 175**

**Fork protectors** / Parasteli forcella >**pag 179**

**Chain guide** / Cruna guida catena >**pag 182**

**Rear shock mud flap** / Paraspruzzi monoammortizzatore >**pag 182**

**Chain slider** / Slitta scorricatena forcellone >**pag 183**

**Chain pads** / Pattino scorricatena >**pag 183**

**Replica plastics kit** / Kit plastiche replica >**pag 184**

# KTM FRONT FENDER / PARAFANGO ANTERIORE



R-PAKTMBN0016



R-PAKTMNR0016



R-PAKTMAR0016

## AVAILABLE COLORS



























OEM original color - fluorescent color

| MODEL | CC                             | YEAR                      | NOTES                                  | COLOR  | CODE  | PRICE   |
|-------|--------------------------------|---------------------------|--|--|---|---------|
| SX    | 50                             | 2016 > 2023               | OEM                                    | K Orange<br>White<br>Black                               | R-PAKTMAR0050<br>R-PAKTMBN0050<br>R-PAKTMNR0050                                   | € 25,95 |
| SX-E  | 3 - 5                          | <b>NEW</b><br>2020 > 2023 | OEM                                    | K Orange<br>White<br>Black                               | R-PAKTMAR0050<br>R-PAKTMBN0050<br>R-PAKTMNR0050                                   | € 25,95 |
| SX    | 65                             | 2002 > 2008               | OEM                                    | K Orange<br>White<br>Black                               | R-PAKTMAR0065<br>R-PAKTMBN0065<br>R-PAKTMNR0065                                   | € 25,95 |
| SX    | 65                             | 2009 > 2011               | OEM - Bi-Color<br>Bi-Color             | K Orange<br>White<br>Black                               | R-PAKTMAR0965<br>R-PAKTMBN0965<br>R-PAKTMNR0965                                   | € 28,95 |
| SX    | 65                             | 2012 > 2015               | OEM - Bi-Color<br>Bi-Color             | K Orange<br>White<br>Black                               | R-PAKTMAR1265<br>R-PAKTMBN1265<br>R-PAKTMNR1265                                   | € 28,95 |
| SX    | 65                             | 2016 > 2023               | OEM                                    | K Orange<br>White<br>Black                               | R-PAKTMAR1665<br>R-PAKTMBN1665<br>R-PAKTMNR1665                                   | € 32,95 |
| SX    | 85                             | 2004 > 2012               | OEM                                    | K Orange<br>White<br>Black                               | R-PAKTMAR0085<br>R-PAKTMBN0085<br>R-PAKTMNR0085                                   | € 25,95 |
| SX    | 85                             | 2013 > 2017               | OEM - Bi-Color<br>Bi-Color             | K Orange<br>White<br>Black                               | R-PAKTMAR0985<br>R-PAKTMBN0985<br>R-PAKTMNR0985                                   | € 29,95 |
| SX    | 85                             | 2018 > 2023               | OEM                                    | K Orange<br>White<br>Black<br>Neon Yellow<br>Neon Orange | R-PAKTMAR0185<br>R-PAKTMBN0185<br>R-PAKTMNR0185<br>R-PAKTMGF0185<br>R-PAKTMAN0185 | € 32,95 |
| SX    | 125-200-250-400-450<br>520-525 | 2003 > 2006               | OEM                                    | K Orange<br>White<br>Black                               | R-PAKTMAR0300<br>R-PAKTMBN0300<br>R-PAKTMNR0300                                   | € 28,95 |
| SX    | 125-144-150-250                | 2007 > 2012               | OEM - Bi-Color<br>Bi-Color<br>Bi-Color | K Orange-Black<br>White-Black<br>Black                   | R-PAKTMAR0007<br>R-PAKTMBN0007<br>R-PAKTMNR0007                                   | € 29,95 |
| SXF   | 250-350-450-505                | 2007 > 2012               | OEM - Bi-Color<br>Bi-Color<br>Bi-Color | K Orange-Black<br>White-Black<br>Black                   | R-PAKTMAR0007<br>R-PAKTMBN0007<br>R-PAKTMNR0007                                   | € 29,95 |
| SX    | 125-150                        | 2013 > 2015               | OEM                                    | K Orange<br>White<br>Black                               | R-PAKTMAR0013<br>R-PAKTMBN0013<br>R-PAKTMNR0013                                   | € 29,95 |
| SXF   | 250-350-450                    | 2013 > 2015               | OEM                                    | K Orange<br>White<br>Black                               | R-PAKTMAR0013<br>R-PAKTMBN0013<br>R-PAKTMNR0013                                   | € 29,95 |
| SX    | 125-150                        | 2016 > 2022               | OEM                                    | K Orange<br>White<br>Black                               | R-PAKTMAR0016<br>R-PAKTMBN0016<br>R-PAKTMNR0016                                   | € 36,95 |
| SX    | 250                            | 2013 > 2016               | OEM                                    | K Orange<br>White<br>Black                               | R-PAKTMAR0013<br>R-PAKTMBN0013<br>R-PAKTMNR0013                                   | € 29,95 |
| SX    | 250                            | 2017 > 2022               | OEM                                    | K Orange<br>White<br>Black                               | R-PAKTMAR0016<br>R-PAKTMBN0016<br>R-PAKTMNR0016                                   | € 36,95 |



**OEM** original color -  fluorescent color

| MODEL                    | CC                               | YEAR        | NOTES                                       | COLOR    |   | CODE          | PRICE   |
|--------------------------|----------------------------------|-------------|---|----------|---|---------------|---------|
| SXF                      | 250-350-450                      | 2016 > 2022 | OEM   | K Orange |  | R-PAKTMAR0016 | € 36,95 |
|                          |                                  |             |   | White    |  | R-PAKTMBN0016 |         |
|                          |                                  |             |   | Black    |  | R-PAKTMR0016  |         |
| SXF                      | 250-450 Factory Edition          | 2018 > 2021 | OEM   | K Orange |  | R-PAKTMAR0016 | € 36,95 |
|                          |                                  |             |   | White    |  | R-PAKTMBN0016 |         |
|                          |                                  |             |   | Black    |  | R-PAKTMR0016  |         |
| XC / XC-F                | 250-350-450                      | 2017 > 2022 | OEM   | K Orange |  | R-PAKTMAR0016 | € 36,95 |
|                          |                                  |             |   | White    |  | R-PAKTMBN0016 |         |
|                          |                                  |             |   | Black    |  | R-PAKTMR0016  |         |
| EXC / EXCF               | 125-200-250-250F-300-400-450-525 | 2003 > 2007 | OEM   | K Orange |  | R-PAKTMAR0300 | € 28,95 |
|                          |                                  |             |   | White    |  | R-PAKTMBN0300 |         |
|                          |                                  |             |   | Black    |  | R-PAKTMR0300  |         |
| EXC / EXCF               | 125-200-250-250F-300-400-450-525 | 2008 > 2012 | OEM - Bi-Color<br>OEM - Bi Color - Six Days | K Orange |  | R-PAKTMAR0007 | € 29,95 |
|                          |                                  |             |   | White    |  | R-PAKTMBN0007 |         |
|                          |                                  |             |   | Black    |  | R-PAKTMR0007  |         |
| EXC / EXCF               | 125 > 500                        | 2014 > 2016 | OEM<br>OEM Six Days                         | K Orange |  | R-PAKTMAR0013 | € 29,95 |
|                          |                                  |             |   | White    |  | R-PAKTMBN0013 |         |
|                          |                                  |             |   | Black    |  | R-PAKTMR0013  |         |
| EXC / EXCF<br>XC-W/XCF-W | 125 > 500                        | 2017 > 2023 | OEM Erzberg Rodeo 2021<br>OEM Six Days 2017 | K Orange |  | R-PAKTMAR0016 | € 36,95 |
|                          |                                  |             |   | White    |  | R-PAKTMBN0016 |         |
|                          |                                  |             |   | Black    |  | R-PAKTMR0016  |         |
| LC4                      | 640                              | 2003 > 2007 | OEM   | K Orange |  | R-PAKTMAR0300 | € 28,95 |
|                          |                                  |             |   | White    |  | R-PAKTMBN0300 |         |
|                          |                                  |             |   | Black    |  | R-PAKTMR0300  |         |

# KTM VENTED FRONT FENDER / PARAFANGO ANTERIORE VENTILATO

ALL FENDERS ON THIS PAGE ARE VENTED AIRFLOW MODELS / PARAFANGO CON PRE-TAGLIO PER LA VENTILAZIONE

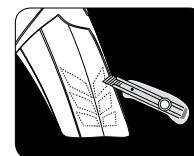

## AVAILABLE COLORS

- K Orange
- Black
- White
- Neon Yellow
- Neon Orange
- Quantum Grey

**OEM** original color - fluorescent color

| MODEL                    | CC                      | YEAR        | NOTES                                    | COLOR        |  | CODE          | PRICE   |
|--------------------------|-------------------------|-------------|--|--------------|--|---------------|---------|
| SX                       | 125-150                 | 2013 > 2015 | OEM                                      | K Orange     |  | R-PAKTMAR9913 | € 29,95 |
|                          |                         |             |  | Neon Orange  |  | R-PAKTMAN9913 |         |
|                          |                         |             |  | White        |  | R-PAKTMBN9913 |         |
|                          |                         |             |  | Black        |  | R-PAKTMNR9913 |         |
| SX                       | 125-150                 | 2016 > 2022 | OEM                                      | K Orange     |  | R-PAKTMAR9916 | € 36,95 |
|                          |                         |             |  | Neon Orange  |  | R-PAKTMAN9916 |         |
|                          |                         |             |  | White        |  | R-PAKTMBN9916 |         |
|                          |                         |             |  | Black        |  | R-PAKTMNR9916 |         |
|                          |                         |             |  | Neon Yellow  |  | R-PAKTMGF9916 |         |
|                          |                         |             |  | Quantum Grey |  | R-PAKTMGR9916 |         |
| SX                       | 250                     | 2013 > 2016 | OEM                                      | K Orange     |  | R-PAKTMAR9913 | € 29,95 |
|                          |                         |             |  | Neon Orange  |  | R-PAKTMAN9913 |         |
|                          |                         |             |  | White        |  | R-PAKTMBN9913 |         |
|                          |                         |             |  | Black        |  | R-PAKTMNR9913 |         |
| SX                       | 250                     | 2017 > 2022 | OEM                                      | K Orange     |  | R-PAKTMAR9916 | € 36,95 |
|                          |                         |             |  | Neon Orange  |  | R-PAKTMAN9916 |         |
|                          |                         |             |  | White        |  | R-PAKTMBN9916 |         |
|                          |                         |             |  | Black        |  | R-PAKTMNR9916 |         |
|                          |                         |             |  | Neon Yellow  |  | R-PAKTMGF9916 |         |
|                          |                         |             |  | Quantum Grey |  | R-PAKTMGR9916 |         |
| SXF                      | 250-350-450             | 2013 > 2015 | OEM                                      | K Orange     |  | R-PAKTMAR9913 | € 29,95 |
|                          |                         |             |  | Neon Orange  |  | R-PAKTMAN9913 |         |
|                          |                         |             |  | White        |  | R-PAKTMBN9913 |         |
|                          |                         |             |  | Black        |  | R-PAKTMNR9913 |         |
| SXF                      | 250-350-450             | 2016 > 2022 | OEM                                      | K Orange     |  | R-PAKTMAR9916 | € 36,95 |
|                          |                         |             |  | Neon Orange  |  | R-PAKTMAN9916 |         |
|                          |                         |             |  | White        |  | R-PAKTMBN9916 |         |
|                          |                         |             |  | Black        |  | R-PAKTMNR9916 |         |
|                          |                         |             |  | Neon Yellow  |  | R-PAKTMGF9916 |         |
|                          |                         |             |  | Quantum Grey |  | R-PAKTMGR9916 |         |
| SXF                      | 250-450 Factory Edition | 2018 > 2021 | OEM                                      | K Orange     |  | R-PAKTMAR9916 | € 36,95 |
|                          |                         |             |  | Neon Orange  |  | R-PAKTMAN9916 |         |
|                          |                         |             |  | White        |  | R-PAKTMBN9916 |         |
|                          |                         |             |  | Black        |  | R-PAKTMNR9916 |         |
| SXF                      | 250-450 Factory Edition | 2018 > 2021 | OEM                                      | Neon Yellow  |  | R-PAKTMGF9916 | € 36,95 |
|                          |                         |             |  | Quantum Grey |  | R-PAKTMGR9916 |         |
|                          |                         |             |  | White 2020   |  | R-PAKTMBN9920 |         |
|                          |                         |             |  | K Orange     |  | R-PAKTMAR9916 |         |
|                          |                         |             |  | Neon Orange  |  | R-PAKTMAN9916 |         |
|                          |                         |             |  | White        |  | R-PAKTMBN9916 |         |
| EXC / EXCF               | 125 > 500               | 2014 > 2016 | OEM                                      | K Orange     |  | R-PAKTMAR9913 | € 29,95 |
|                          |                         |             |  | Neon Orange  |  | R-PAKTMAN9913 |         |
|                          |                         |             |  | White        |  | R-PAKTMBN9913 |         |
|                          |                         |             |  | Black        |  | R-PAKTMNR9913 |         |
| EXC / EXCF<br>XC-W/XCF-W | 125 > 500               | 2017 > 2023 | OEM<br>OEM - Six Days 2017               | K Orange     |  | R-PAKTMAR9916 | € 36,95 |
|                          |                         |             |  | White        |  | R-PAKTMBN9916 |         |
|                          |                         |             |  | Neon Orange  |  | R-PAKTMAN9916 |         |
|                          |                         |             |  | Black        |  | R-PAKTMNR9916 |         |
|                          |                         |             |  | Quantum Grey |  | R-PAKTMGR9916 |         |
|                          |                         |             |  | Neon Yellow  |  | R-PAKTMGF9916 |         |
| XC / XC-F                | 250-350-450             | 2017 > 2022 | OEM<br>OEM Six Days / Erzberg Rodeo 2020 | White 2020   |  | R-PAKTMBN9920 | € 36,95 |
|                          |                         |             |  | K Orange     |  | R-PAKTMAR9916 |         |
|                          |                         |             |  | Neon Orange  |  | R-PAKTMAN9916 |         |
|                          |                         |             |  | White        |  | R-PAKTMBN9916 |         |
|                          |                         |             |  | Black        |  | R-PAKTMNR9916 |         |
|                          |                         |             |  | Neon Yellow  |  | R-PAKTMGF9916 |         |

# KTM REAR FENDER / PARAFANGO POSTERIORE



R-PPKTMAR0019



R-PPKTMBN0019



R-PPKTMNR0019



 NEON

R-PPKTMAN0019



R-PPKTMGR0019

















































R-PPKTMCL0019



 NEON







































R-PPKTMGF0019

**OEM** original color -  fluorescent color





























































| MODEL    | CC          | YEAR        | NOTES  | COLOR       |   | CODE          | PRICE   |
|----------|-------------|-------------|--|-------------|---|---------------|---------|
| SX       | 50          | 2016 > 2023 | OEM  | K Orange    |    | R-CDKTMAR0050 | € 49,95 |
|          |             |             |  | White       |    | R-CDKTMBN0050 |         |
|          |             |             |  | Black       |   | R-CDKTMNR0050 |         |
| SX-E     | 3 - 5       | 2020 > 2023 | OEM  | K Orange    |   | R-CDKTMAR0050 | € 49,95 |
|          |             |             |  | White       |  | R-CDKTMBN0050 |         |
|          |             |             |  | Black       |  | R-CDKTMNR0050 |         |
| SX       | 65          | 2002 > 2008 | OEM  | K Orange    |  | R-CDKTMAR0065 | € 52,95 |
|          |             |             |  | White       |  | R-CDKTMBN0065 |         |
|          |             |             |  | Black       |  | R-CDKTMNR0065 |         |
| SX       | 65          | 2009 > 2015 | OEM 2009-2010 E 2013 > 15<br>OEM 2011-2012   | K Orange    |  | R-CDKTMAR0965 | € 62,95 |
|          |             |             |  | White       |  | R-CDKTMBN0965 |         |
|          |             |             |  | Black       |  | R-CDKTMNR0965 |         |
| SX       | 65          | 2016 > 2023 | OEM  | White       |  | R-PPKTMBN1665 | € 62,95 |
|          |             |             |  | K Orange    |  | R-PPKTMAR1665 |         |
|          |             |             |  | Black       |  | R-PPKTMNR1665 |         |
| SX       | 85          | 2004 > 2012 | OEM 2011-2012<br>OEM 2003 > 2010             | White       |  | R-CDKTMBN0085 | € 59,95 |
|          |             |             |  | K Orange    |  | R-CDKTMAR0085 |         |
|          |             |             |  | Black       |  | R-CDKTMNR0085 |         |
| SX       | 85          | 2013 > 2017 | OEM 2016-2017<br>OEM 2013 > 2015             | White       |  | R-PPKTMBN0985 | € 29,95 |
|          |             |             |  | K Orange    |  | R-PPKTMAR0985 |         |
|          |             |             |  | Black       |  | R-PPKTMNR0985 |         |
| SX       | 85          | 2018 > 2023 | OEM 2019 > 2023<br>OEM 2018                  | White       |  | R-PPKTMBN0185 | € 32,95 |
|          |             |             |  | K Orange    |  | R-PPKTMAR0185 |         |
|          |             |             |  | Black       |  | R-PPKTMNR0185 |         |
| SX       | 85          | 2018 > 2023 | OEM 2019 > 2023<br>OEM 2018                  | Neon Yellow |  | R-PPKTMGF0185 | € 32,95 |
|          |             |             |  | Neon Orange |  | R-PPKTMAN0185 |         |
|          |             |             |  | Light Blue  |  | R-PPKTMCL0185 |         |
| SX-EXC   | 125         | 1998 > 2003 | OEM  | K Orange    |  | R-PPKTMAR9802 | € 31,95 |
|          |             |             |  | White       |  | R-PPKTMBN9802 |         |
|          |             |             |  | Black       |  | R-PPKTMNR9802 |         |
| SX       | 250         | 1998 > 2002 | OEM  | K Orange    |  | R-PPKTMAR9802 | € 31,95 |
|          |             |             |  | White       |  | R-PPKTMBN9802 |         |
|          |             |             |  | Black       |  | R-PPKTMNR9802 |         |
| SX       | 380         | 1998 > 2001 | OEM  | K Orange    |  | R-PPKTMAR9802 | € 31,95 |
|          |             |             |  | White       |  | R-PPKTMBN9802 |         |
|          |             |             |  | Black       |  | R-PPKTMNR9802 |         |
| EXC      | 250         | 1998 > 2003 | OEM  | K Orange    |  | R-PPKTMAR9802 | € 31,95 |
|          |             |             |  | White       |  | R-PPKTMBN9802 |         |
|          |             |             |  | Black       |  | R-PPKTMNR9802 |         |
| SX / EXC | 400-520     | 2000 > 2002 | OEM  | K Orange    |  | R-PPKTMAR9802 | € 31,95 |
|          |             |             |  | White       |  | R-PPKTMBN9802 |         |
|          |             |             |  | Black       |  | R-PPKTMNR9802 |         |
| SX / EXC | 525         | 2003        | OEM - Compatible MY2023<br>Compatible MY2023 | K Orange    |  | R-PPKTMAR9802 | € 31,95 |
|          |             |             |  | White       |  | R-PPKTMBN9802 |         |
|          |             |             |  | Black       |  | R-PPKTMNR9802 |         |
| EXC      | 200-300-450 | 2003        | OEM - Compatible MY2023<br>Compatible MY2023 | K Orange    |  | R-PPKTMAR9802 | € 31,95 |
|          |             |             |  | White       |  | R-PPKTMBN9802 |         |
|          |             |             |  | Black       |  | R-PPKTMNR9802 |         |
| SX       | 200         | 2003-2004   | OEM  | K Orange    |  | R-PPKTMAR9802 | € 31,95 |
|          |             |             |  | White       |  | R-PPKTMBN9802 |         |
|          |             |             |  | Black       |  | R-PPKTMNR9802 |         |

# KTM REAR FENDER / PARAFANGO POSTERIORE

**OEM** original color -  fluorescent color

| MODEL    | CC                          | YEAR        | NOTES                                   | COLOR        |   | CODE          | PRICE   |
|----------|-----------------------------|-------------|---|--------------|---|---------------|---------|
| SX       | 250-450                     | 2003 > 2006 | OEM                                     | K Orange     |    | R-CDKTMAR04XC | € 76,95 |
|          |                             |             |   | White        |    | R-CDKTMBN04XC |         |
|          |                             |             |   | Black        |    | R-CDKTMR04XC  |         |
| SX / SXF | 125-525                     | 2004 > 2006 | OEM                                     | K Orange     |    | R-CDKTMAR04XC | € 76,95 |
|          |                             |             |   | White        |    | R-CDKTMBN04XC |         |
|          |                             |             |   | Black        |    | R-CDKTMR04XC  |         |
| SX       | 125-144-150-250             | 2007 > 2010 | OEM                                     | K Orange     |    | R-CDKTMAR07   | € 76,95 |
|          |                             |             |   | White        |    | R-CDKTMBNS07  |         |
|          |                             |             |   | Black        |    | R-CDKTMR07    |         |
| SXF      | 250-450-505                 | 2007 > 2010 | OEM                                     | K Orange     |    | R-CDKTMAR07   | € 76,95 |
|          |                             |             |   | White        |    | R-CDKTMBNS07  |         |
|          |                             |             |   | Black        |    | R-CDKTMR07    |         |
| SX       | 125-150                     | 2011 > 2015 | OEM 2013 > 2015<br>OEM 2011-2012        | K Orange     |    | R-PPKTMAR0011 | € 29,95 |
|          |                             |             |   | White        |    | R-PPKTMBN0011 |         |
|          |                             |             |   | Black        |    | R-PPKTMR0011  |         |
| SX       | 125-150                     | 2016 > 2018 | OEM 2017-2018<br>OEM 2016               | K Orange     |    | R-PPKTMAR0016 | € 42,95 |
|          |                             |             |   | White        |    | R-PPKTMBN0016 |         |
|          |                             |             |   | Neon Orange  |    | R-PPKTMAN0016 |         |
|          |                             |             |   | Black        |    | R-PPKTMR0016  |         |
|          |                             |             |   | Neon Yellow  |   | R-PPKTMGF0016 |         |
|          |                             |             |   | Light Blue   |  | R-PPKTMCLO016 |         |
|          |                             |             |   | Quantum Grey |  | R-PPKTMR0016  |         |
| SX       | 125-150-250                 | 2019 > 2022 | OEM                                     | White        |  | R-PPKTMBN0019 | € 42,95 |
|          |                             |             |   | K Orange     |  | R-PPKTMAR0019 |         |
|          |                             |             |   | Black        |  | R-PPKTMR0019  |         |
|          |                             |             |   | Neon Yellow  |  | R-PPKTMGF0019 |         |
|          |                             |             |   | Neon Orange  |  | R-PPKTMAN0019 |         |
|          |                             |             |   | Light Blue   |  | R-PPKTMCLO019 |         |
|          |                             |             |   | Quantum Grey |  | R-PPKTMR0019  |         |
| SX       | 250                         | 2011 > 2016 | OEM 2013 > 2015<br>OEM 2011-2012 e 2016 | K Orange     |  | R-PPKTMAR0011 | € 29,95 |
|          |                             |             |   | White        |  | R-PPKTMBN0011 |         |
|          |                             |             |   | Black        |  | R-PPKTMR0011  |         |
| SX       | 250                         | 2017-2018   | OEM 2017-2018                           | K Orange     |  | R-PPKTMAR0016 | € 42,95 |
|          |                             |             |   | White        |  | R-PPKTMBN0016 |         |
|          |                             |             |   | Neon Orange  |  | R-PPKTMAN0016 |         |
|          |                             |             |   | Black        |  | R-PPKTMR0016  |         |
|          |                             |             |   | Neon Yellow  |  | R-PPKTMGF0016 |         |
|          |                             |             |   | Light Blue   |  | R-PPKTMCLO016 |         |
|          |                             |             |   | Quantum Grey |  | R-PPKTMR0016  |         |
| SXF      | 250-350-450                 | 2011 > 2015 | OEM 2013 > 2015<br>OEM 2011-2012        | K Orange     |  | R-PPKTMAR0011 | € 29,95 |
|          |                             |             |   | White        |  | R-PPKTMBN0011 |         |
|          |                             |             |   | Black        |  | R-PPKTMR0011  |         |
| SXF      | 250-350-450                 | 2016 > 2018 | OEM 2017-2018<br>OEM 2016               | K Orange     |  | R-PPKTMAR0016 | € 42,95 |
|          |                             |             |   | White        |  | R-PPKTMBN0016 |         |
|          |                             |             |   | Neon Orange  |  | R-PPKTMAN0016 |         |
|          |                             |             |   | Black        |  | R-PPKTMR0016  |         |
|          |                             |             |   | Neon Yellow  |  | R-PPKTMGF0016 |         |
|          |                             |             |   | Light Blue   |  | R-PPKTMCLO016 |         |
|          |                             |             |   | Quantum Grey |  | R-PPKTMR0016  |         |
| SXF      | 250-350-450                 | 2019 > 2022 | OEM                                     | White        |  | R-PPKTMBN0019 | € 42,95 |
|          |                             |             |   | K Orange     |  | R-PPKTMAR0019 |         |
|          |                             |             |   | Black        |  | R-PPKTMR0019  |         |
|          |                             |             |   | Neon Yellow  |  | R-PPKTMGF0019 |         |
|          |                             |             |   | Neon Orange  |  | R-PPKTMAN0019 |         |
|          |                             |             |   | Light Blue   |  | R-PPKTMCLO019 |         |
|          |                             |             |   | Quantum Grey |  | R-PPKTMR0019  |         |
| SXF      | 250-450 Factory Edition     | 2018 > 2021 | OEM                                     | White        |  | R-PPKTMBN0019 | € 42,95 |
|          |                             |             |   | K Orange     |  | R-PPKTMAR0019 |         |
|          |                             |             |   | Black        |  | R-PPKTMR0019  |         |
|          |                             |             |   | Neon Yellow  |  | R-PPKTMGF0019 |         |
|          |                             |             |   | Neon Orange  |  | R-PPKTMAN0019 |         |
|          |                             |             |   | Light Blue   |  | R-PPKTMCLO019 |         |
|          |                             |             |   | Quantum Grey |  | R-PPKTMR0019  |         |
| EXC      | 125-200-250-300-400-450-525 | 2004 > 2007 | OEM                                     | K Orange     |  | R-CDKTMAR04XC | € 76,95 |
|          |                             |             |   | White        |  | R-CDKTMBN04XC |         |
|          |                             |             |   | Black        |  | R-CDKTMR04XC  |         |
| EXCF     | 250F                        | 2007        | OEM                                     | K Orange     |  | R-CDKTMAR04XC | € 76,95 |
|          |                             |             |   | White        |  | R-CDKTMBN04XC |         |
|          |                             |             |   | Black        |  | R-CDKTMR04XC  |         |

OEM original color -  fluorescent color

| MODEL                      | CC              | YEAR        | NOTES  | COLOR              |   | CODE          | PRICE   |
|----------------------------|-----------------|-------------|--|--------------------|---|---------------|---------|
| EXC                        | 125-250-300     | 2008 > 2011 | OEM 2011<br>OEM 2008 > 2010  | White              |    | R-CDKTMBNEXC8 | € 76,95 |
|                            |                 |             |  | K Orange           |    | R-CDKTMAREXC8 |         |
|                            |                 |             |  | Black              |    | R-CDKTMNREXC8 |         |
| EXCF                       | 250-450-530     | 2008 > 2011 | OEM 2011<br>OEM 2008 > 2010  | White              |    | R-CDKTMBNEXC8 | € 76,95 |
|                            |                 |             |  | K Orange           |    | R-CDKTMAREXC8 |         |
|                            |                 |             |  | Black              |    | R-CDKTMNREXC8 |         |
| EXC / EXCF                 | 125 > 500       | 2012 > 2016 | OEM EXC/EXCF 2012 > 2016<br><br>OEM EXC Six Days 2012 > 2016   | K Orange           |    | R-PPKTMAR0012 | € 29,95 |
|                            |                 |             |  | Neon Orange        |       | R-PPKTMAN0012 |         |
|                            |                 |             |  | White              |    | R-PPKTMBN0012 |         |
|                            |                 |             |  | Black              |    | R-PPKTMNR0012 |         |
|                            |                 |             |  | White              |    | R-PPKTMAR0017 |         |
| EXC / EXCF                 | 125 > 500       | 2017 > 2019 | OEM<br><br>OEM EXC Six Days<br><br>Limited Edition<br>Limited Edition  | Neon Orange        |       | R-PPKTMAN0017 | € 42,95 |
|                            |                 |             |  | White              |    | R-PPKTMBN0017 |         |
|                            |                 |             |  | Black              |    | R-PPKTMNR0017 |         |
|                            |                 |             |  | Neon Yellow        |       | R-PPKTMGF0017 |         |
|                            |                 |             |  | Light Blue         |    | R-PPKTMCL0017 |         |
|                            |                 |             |  | Blue Six Days 2018 |    | R-PPKTMBL0017 |         |
|                            |                 |             |  | Quantum Grey       |    | R-PPKTMGR0017 |         |
|                            |                 |             |  | Black              |    | R-PPKTMNR0020 |         |
|                            |                 |             |  | White              |    | R-PPKTMBN0020 |         |
|                            |                 |             |  | Neon Orange        |      | R-PPKTMAN0020 |         |
| EXC / EXCF<br>XC-W / XCF-W | 125 > 500       | 2020 > 2023 | OEM 2020 - Six Days 2020<br>OEM 2023 - Erzberg Rodeo 2021 - Six Days 2021<br><br>OEM 2021-2022<br><br>Limited Edition<br>Replica Wess 350 2021 | K Orange           |    | R-PPKTMAR0020 | € 42,95 |
|                            |                 |             |  | Neon Yellow        |   | R-PPKTMGF0020 |         |
|                            |                 |             |  | Light Blue         |    | R-PPKTMCL0020 |         |
|                            |                 |             |  | Quantum Grey       |    | R-PPKTMGR0020 |         |
|                            |                 |             |  | Grey 2021          |    | R-PPKTMGA0020 |         |
|                            |                 |             |  | K Orange           |    | R-PPKTMAR0016 |         |
|                            |                 |             |  | White              |    | R-PPKTMBN0016 |         |
| XC / XC-F                  | 250-300-350-450 | 2017-2018   | OEM  | Neon Orange        |   | R-PPKTMAN0016 | € 42,95 |
|                            |                 |             |  | Black              |    | R-PPKTMNR0016 |         |
|                            |                 |             |  | Neon Yellow        |   | R-PPKTMGF0016 |         |
|                            |                 |             |  | Light Blue         |    | R-PPKTMCL0016 |         |
|                            |                 |             |  | Quantum Grey       |    | R-PPKTMGR0016 |         |
|                            |                 |             |  | White              |    | R-PPKTMBN0019 |         |
|                            |                 |             |  | K Orange           |    | R-PPKTMAR0019 |         |
|                            |                 |             |  | Black              |    | R-PPKTMNR0019 |         |
|                            |                 |             |  | Neon Yellow        |   | R-PPKTMGF0019 |         |
|                            |                 |             |  | Neon Orange        |   | R-PPKTMAN0019 |         |
| XC / XC-F                  | 250-300-350-450 | 2019 > 2022 | OEM<br><br>Limited Edition   | Light Blue         |    | R-PPKTMCL0019 | € 42,95 |
|                            |                 |             |  | Quantum Grey       |    | R-PPKTMGR0019 |         |
|                            |                 |             |  | K Orange           |    | R-PPKTMAR0017 |         |
|                            |                 |             |  | Neon Orange        |   | R-PPKTMAN0017 |         |
|                            |                 |             |  | White              |    | R-PPKTMBN0017 |         |
| XC-W                       | 125 > 300       | 2017 > 2019 | OEM<br><br>Limited Edition<br>Limited Edition  | Black              |    | R-PPKTMNR0017 | € 42,95 |
|                            |                 |             |  | Neon Yellow        |   | R-PPKTMGF0017 |         |
|                            |                 |             |  | Light Blue         |    | R-PPKTMCL0017 |         |
|                            |                 |             |  | Blue Six Days 2018 |    | R-PPKTMBL0017 |         |
|                            |                 |             |  | Quantum Grey       |    | R-PPKTMGR0017 |         |



## AVAILABLE COLORS

|  |              |  |                   |
|--|--------------|--|-------------------|
|  | K Orange     |  | White-K Orange    |
|  | Black        |  | K Orange-Black    |
|  | White        |  | Blue-K Orange     |
|  | Light Blue   |  | Red Vintage-Black |
|  | Quantum Grey |  | Light Blue-Black  |
|  | Neon Orange  |  | Neon Orange-Black |
|  | White-Black  |  | Neon Yellow-Black |
|  | Quantum Grey |  | Grey 2021         |





























































R-CVKTMRNR16

**OEM** original color - fluorescent color

| MODEL           | CC                           | YEAR        | NOTES   | COLOR             | CODE            | PRICE   |         |
|-----------------|------------------------------|-------------|---|-------------------|-----------------|---------|---------|
| <b>SX</b>       | 50                           | 2016 > 2023 | OEM 2019 > 2022<br>OEM 2016 and 2018<br>OEM 2017                        | K Orange          | R-CVKTMR0050    | € 57,95 |         |
|                 |                              |             |   | White-K Orange    | R-CVKTMBN0050   |         |         |
|                 |                              |             |   | K Orange-Black    | R-CVKTMRNR0050  |         |         |
|                 |                              |             |   | White-Black       | R-CVKTMBN0050   |         |         |
|                 |                              |             |   | White             | R-CVKTMBN0050   |         |         |
|                 |                              |             |   | Black             | R-CVKTMRNR0050  |         |         |
|                 |                              |             |   | Black             | R-CVKTMRNR0050  |         |         |
| <b>SX-E</b>     | 3 - 5                        | 2020 > 2023 | OEM 2023<br>OEM 2020 > 2022   | K Orange          | R-CVKTMR0050    | € 57,95 |         |
|                 |                              |             |   | White-K Orange    | R-CVKTMBN0050   |         |         |
|                 |                              |             |   | K Orange-Black    | R-CVKTMRNR0050  |         |         |
|                 |                              |             |   | White-Black       | R-CVKTMBN0050   |         |         |
|                 |                              |             |   | White             | R-CVKTMBN0050   |         |         |
|                 |                              |             |   | Black             | R-CVKTMRNR0050  |         |         |
|                 |                              |             |   | Black             | R-CVKTMRNR0050  |         |         |
| <b>SX</b>       | 65                           | 2002 > 2008 | OEM   | K Orange          | R-CVKTMR0065    | € 42,95 |         |
|                 |                              |             |   | White             | R-CVKTMBN0065   |         |         |
|                 |                              |             |   | Black             | R-CVKTMRNR0065  |         |         |
| <b>SX</b>       | 65                           | 2009 > 2015 | OEM 2011 > 2015<br>OEM 2009-2010  | K Orange          | R-CVKTMR0965    | € 49,95 |         |
|                 |                              |             |   | Black             | R-CVKTMRNR0965  |         |         |
|                 |                              |             |   | White             | R-CVKTMBN0965   |         |         |
| <b>SX</b>       | 65                           | 2016 > 2023 | OEM - Bi-Color 2019>2022<br>OEM - Bi-Color 2016-2018                    | White-K Orange    | R-CVKTMBNAR1665 | € 57,95 |         |
|                 |                              |             |   | K Orange-Black    | R-CVKTMRNR1665  |         |         |
|                 |                              |             |   | Black             | R-CVKTMRNR1665  |         |         |
|                 |                              |             |   | White             | R-CVKTMBN1665   |         |         |
|                 |                              |             |   | White-Black       | R-CVKTMBNNR1665 |         |         |
| <b>SX</b>       | 85                           | 2006 > 2012 | OEM - adaptable SX 85 from 2003<br>adaptable from 2003                  | K Orange          | R-CVKTMR0085    | € 49,95 |         |
|                 |                              |             |   | White             | R-CVKTMBN0085   |         |         |
|                 |                              |             |   | Black             | R-CVKTMRNR0085  |         |         |
| <b>SX</b>       | 85                           | 2013 > 2017 | OEM 2015 - Bi-Color<br>OEM 2013-2014 and 2016 - Bi-Color                | White-K Orange    | R-CVKTMBNAR985  | € 57,95 |         |
|                 |                              |             |   | K Orange-Black    | R-CVKTMR0985    |         |         |
|                 |                              |             |   | White-Black       | R-CVKTMBNNR985  |         |         |
|                 |                              |             |   | White             | R-CVKTMBN0985   |         |         |
|                 |                              |             |   | Black             | R-CVKTMRNR0985  |         |         |
| <b>SX</b>       | 85                           | 2018 > 2023 | OEM 2019>2022 - Bi-Color<br>OEM - Bi-Color 2018                         | White-K Orange    | R-CVKTMBNAR185  | € 59,95 |         |
|                 |                              |             |   | K Orange - Black  | R-CVKTMRNR185   |         |         |
|                 |                              |             |   | K Orange          | R-CVKTMR0185    |         |         |
|                 |                              |             |   | Black             | R-CVKTMRNR0185  |         |         |
|                 |                              |             |   | White             | R-CVKTMBN0185   |         |         |
|                 |                              |             |   | Neon Yellow-Black | R-CVKTMGF0185   |         |         |
|                 |                              |             |   | Neon Orange       | R-CVKTMAN0185   |         |         |
|                 |                              |             |   | Light Blue        | R-CVKTMCNLR185  |         |         |
|                 |                              |             |   | K Orange          | R-CVKTMR9802    |         | € 56,95 |
|                 |                              |             |   | Black             | R-CVKTMRNR9802  |         |         |
| <b>SX</b>       | 400-520                      | 2000        | OEM   | K Orange          | R-CVKTMR9802    | € 56,95 |         |
|                 |                              |             |   | Black             | R-CVKTMRNR9802  |         |         |
| <b>SX</b>       | 125-250                      | 2001-2002   | OEM   | K Orange          | R-CVKTMR9803    | € 56,95 |         |
|                 |                              |             |   | Black             | R-CVKTMRNR9803  |         |         |
| <b>SX</b>       | 125-250                      | 2001 > 2004 | OEM   | K Orange          | R-CVKTMR9803    | € 56,95 |         |
|                 |                              |             |   | Black             | R-CVKTMRNR9803  |         |         |
| <b>SX</b>       | 125-250-450-525              | 2005-2006   | OEM   | K Orange          | R-CVKTMR0005    | € 56,95 |         |
|                 |                              |             |   | White             | R-CVKTMBN0005   |         |         |
|                 |                              |             |   | Black             | R-CVKTMRNR0005  |         |         |
| <b>SX</b>       | 125-150-250                  | 2007 > 2010 | OEM   | Black             | R-CVKTMRNR0007  | € 59,95 |         |
|                 |                              |             |   | K Orange          | R-CVKTMR0007    |         |         |
|                 |                              |             |   | White             | R-CVKTMBN0007   |         |         |
| <b>SXF</b>      | 250-450-505                  | 2007 > 2010 | OEM   | Black             | R-CVKTMRNR0007  | € 59,95 |         |
|                 |                              |             |   | K Orange          | R-CVKTMR0007    |         |         |
|                 |                              |             |   | White             | R-CVKTMBN0007   |         |         |
| <b>SX / SXF</b> | 125-150-250-250F<br>350F-450 | 2011-2012   | OEM   | K Orange          | R-CVKTMR0011    | € 59,95 |         |
|                 |                              |             |   | White             | R-CVKTMBN0011   |         |         |
|                 |                              |             |   | Black             | R-CVKTMRNR0011  |         |         |
|                 |                              |             |   | Black             | R-CVKTMRNR0011  |         |         |
| <b>SX</b>       | 125-150                      | 2013 > 2015 | OEM 2015 - Bi-Color<br>OEM 2013-2014 - Bi-Color<br>Bi-Color<br>Bi-Color | White-K Orange    | R-CVKTMBNAR13   | € 59,95 |         |
|                 |                              |             |   | K Orange-Black    | R-CVKTMRNR13    |         |         |
|                 |                              |             |   | White-Black       | R-CVKTMBNNR13   |         |         |
|                 |                              |             |   | White-Neon Orange | R-CVKTMBNAN13   |         |         |
|                 |                              |             |   | Black             | R-CVKTMRNR0013  |         |         |

**OEM** original color -  fluorescent color



























| MODEL           | CC  | YEAR  | NOTES  | COLOR   | CODE  | PRICE         |         |
|-----------------|---|---|--|---|---|---------------|---------|
| SX              | 125-150   | 2016 > 2018   | OEM 2017 - Bi-Color<br>OEM 2016 and 2018 - Bi-Color                  | White K-Black   |    | R-CVKTMBNRR16 | € 59,95 |
|                 |   |   |  | K Orange-Black  |    | R-CVKTMBNRR16 |         |
|                 |   |   | Bi-Color   | Black   |    | R-CVKTMBNRR16 |         |
|                 |   |   |  | Neon Yellow-Black    |    | R-CVKTMBNRR16 |         |
|                 |   |   | Bi-Color   | K Orange  |    | R-CVKTMBNRR16 |         |
|                 |   |   |  | Neon Orange   |    | R-CVKTMBNRR16 |         |
|                 |   |   | Bi-Color   | Light Blue-Black  |    | R-CVKTMBNRR16 |         |
|                 |   |   |  | White   |    | R-CVKTMBNRR16 |         |
|                 |   |   | Limited Edition  | Quantum Grey  |    | R-CVKTMBNRR16 |         |
|                 |   |   |  | White-K Orange  |    | R-CVKTMBNRR19 |         |
| SX              | 125-150-250   | 2019 > 2022   | OEM - Bi-Color<br>Bi-Color   | White K-Black   |    | R-CVKTMBNRR19 | € 59,95 |
|                 |   |   |  | White K-Red   |    | R-CVKTMBNRR19 |         |
|                 |   |   | Bi-Color   | White   |    | R-CVKTMBNRR19 |         |
|                 |   |   |  | K Orange  |    | R-CVKTMBNRR19 |         |
|                 |   |   | Bi-Color   | K Orange-Black  |   | R-CVKTMBNRR19 |         |
|                 |   |   |  | Black-K Orange  |  | R-CVKTMBNRR19 |         |
|                 |   |   | Bi-Color   | Black   |  | R-CVKTMBNRR19 |         |
|                 |   |   |  | Neon Yellow-Black  |  | R-CVKTMBNRR19 |         |
|                 |   |   | Bi-Color   | Neon Orange        |  | R-CVKTMBNRR19 |         |
|                 |   |   |  | Light Blue  |  | R-CVKTMBNRR19 |         |
| Limited Edition | Quantum Grey  |  | R-CVKTMBNRR19  |   |   |               |         |
|                 | Blue-K Orange   |  | R-CVKTMBNRR19  |   |   |               |         |
| SX              | 250   | 2013 > 2016   | OEM 2013-2014 and 2016 - Bi-Color<br>Bi-Color<br>OEM 2015 - Bi-Color | Grey 2021   |  | R-CVKTMBNRR19 | € 59,95 |
|                 |   |   |  | Grey 2021-K Orange  |  | R-CVKTMBNRR19 |         |
|                 |   |   | Bi-Color   | K Orange-Black  |  | R-CVKTMBNRR13 |         |
|                 |   |   |  | White K-Black   |  | R-CVKTMBNRR13 |         |
|                 |   |   | Bi-Color   | White-K Orange  |  | R-CVKTMBNRR13 |         |
|                 |   |   |  | Black   |  | R-CVKTMBNRR13 |         |
|                 |   |   | Bi-Color   | White-Neon Orange  |  | R-CVKTMBNRR13 |         |
|                 |   |   |  | White-K-Black   |  | R-CVKTMBNRR16 |         |
|                 |   |   | Bi-Color   | K Orange-Black  |  | R-CVKTMBNRR16 |         |
|                 |   |   |  | Black   |  | R-CVKTMBNRR16 |         |
| Bi-Color        | Neon Yellow-Black  |  | R-CVKTMBNRR16  |   |   |               |         |
|                 | K Orange  |  | R-CVKTMBNRR16  |   |   |               |         |
| Bi-Color        | Neon Orange   |  | R-CVKTMBNRR16  |   |   |               |         |
|                 | Light Blue-Black  |  | R-CVKTMBNRR16  |   |   |               |         |
| Bi-Color        | White   |  | R-CVKTMBNRR16  |   |   |               |         |
|                 | Quantum Grey  |  | R-CVKTMBNRR16  |   |   |               |         |
| SXF             | 250-350-450   | 2013 > 2015   | OEM 2017 - Bi-Color<br>OEM 2018 - Bi-Color                           | K Orange-Black  |  | R-CVKTMBNRR13 | € 59,95 |
|                 |   |   |  | White K-Black   |  | R-CVKTMBNRR13 |         |
|                 |   |   | Bi-Color   | White-K Orange  |  | R-CVKTMBNRR13 |         |
|                 |   |   |  | Black   |  | R-CVKTMBNRR13 |         |
|                 |   |   | Bi-Color   | White-Neon Orange  |  | R-CVKTMBNRR13 |         |
|                 |   |   |  | White K-Black   |  | R-CVKTMBNRR16 |         |
|                 |   |   | Bi-Color   | K Orange-Black  |  | R-CVKTMBNRR16 |         |
|                 |   |   |  | Black   |  | R-CVKTMBNRR16 |         |
|                 |   |   | Bi-Color   | Neon Yellow-Black  |  | R-CVKTMBNRR16 |         |
|                 |   |   |  | K Orange  |  | R-CVKTMBNRR16 |         |
| Bi-Color        | Neon Orange   |  | R-CVKTMBNRR16  |   |   |               |         |
|                 | Light Blue-Black  |  | R-CVKTMBNRR16  |   |   |               |         |
| Bi-Color        | White   |  | R-CVKTMBNRR16  |   |   |               |         |
|                 | Quantum Grey  |  | R-CVKTMBNRR16  |   |   |               |         |
| SXF             | 250-350-450   | 2016-2018   | OEM 2017 - Bi-Color<br>OEM 2018 - Bi-Color                           | White K-Black   |  | R-CVKTMBNRR16 | € 59,95 |
|                 |   |   |  | K Orange-Black  |  | R-CVKTMBNRR16 |         |
|                 |   |   | Bi-Color   | Black   |  | R-CVKTMBNRR16 |         |
|                 |   |   |  | Neon Yellow-Black  |  | R-CVKTMBNRR16 |         |
|                 |   |   | Bi-Color   | K Orange  |  | R-CVKTMBNRR16 |         |
|                 |   |   |  | Neon Orange   |  | R-CVKTMBNRR16 |         |
|                 |   |   | Bi-Color   | Light Blue-Black  |  | R-CVKTMBNRR16 |         |
|                 |   |   |  | White   |  | R-CVKTMBNRR16 |         |
|                 |   |   | Limited Edition  | Quantum Grey  |  | R-CVKTMBNRR16 |         |
|                 |   |   |  | White-K Orange  |  | R-CVKTMBNRR19 |         |
| OEM - Bi-Color  | White K-Black   |  | R-CVKTMBNRR19  |   |   |               |         |
|                 | White K-Red   |  | R-CVKTMBNRR19  |   |   |               |         |
| Bi-Color        | White   |  | R-CVKTMBNRR19  |   |   |               |         |
|                 | K Orange  |  | R-CVKTMBNRR19  |   |   |               |         |
| Bi-Color        | Black   |  | R-CVKTMBNRR19  |   |   |               |         |
|                 | K Orange-Black  |  | R-CVKTMBNRR19  |   |   |               |         |
| Bi-Color        | Black-K Orange  |  | R-CVKTMBNRR19  |   |   |               |         |
|                 | Neon Yellow-Black  |  | R-CVKTMBNRR19  |   |   |               |         |
| Bi-Color        | Neon Orange        |  | R-CVKTMBNRR19  |   |   |               |         |
|                 | Light Blue  |  | R-CVKTMBNRR19  |   |   |               |         |
| Limited Edition | Quantum Grey  |  | R-CVKTMBNRR19  |   |   |               |         |
|                 | Blue-K Orange   |  | R-CVKTMBNRR19  |   |   |               |         |
| Limited Edition | Grey 2021   |  | R-CVKTMBNRR19  |   |   |               |         |
|                 | Grey 2021-K Orange  |  | R-CVKTMBNRR19  |   |   |               |         |

# KTM RADIATOR SHROUDS / CONVOGLIATORI ARIA RADIATORE

OEM original color - ☀️ fluorescent color

| MODEL                    | CC                            | YEAR        | NOTES  | COLOR                | CODE | PRICE          |         |
|--------------------------|-------------------------------|-------------|--|----------------------|------|----------------|---------|
| SXF                      | 250-450 Factory Edition       | 2018 > 2021 | Bi-Color<br>Bi-Color   | White-K Orange       |      | R-CVKTMBNAR19  | € 59,95 |
|                          |                               |             |  | White-Black          |      | R-CVKTMBNNR19  |         |
|                          |                               |             |  | White K-Red          |      | R-CVKTMBNRS19  |         |
|                          |                               |             |  | White                |      | R-CVKTMBN0019  |         |
|                          |                               |             |  | K Orange             |      | R-CVKTMAR0019  |         |
|                          |                               |             |  | Black                |      | R-CVKTMR0019   |         |
|                          |                               |             |  | K Orange-Black       |      | R-CVKTMRNR19   |         |
|                          |                               |             |  | Black-K Orange       |      | R-CVKTMRNR19   |         |
|                          |                               |             |  | Neon Yellow-Black ☀️ |      | R-CVKTMGFNR19  |         |
|                          |                               |             |  | Neon Orange ☀️       |      | R-CVKTMAN0019  |         |
|                          |                               |             |  | Light Blue           |      | R-CVKTMCLO019  |         |
|                          |                               |             |  | Quantum Grey         |      | R-CVKTMGRO019  |         |
|                          |                               |             |  | Blue-K Orange        |      | R-CVKTMBLAR19  |         |
|                          |                               |             |  | Grey 2021            |      | R-CVKTMGAA019  |         |
|                          |                               |             |  | Grey 2021-K Orange   |      | R-CVKTMGAA019  |         |
| EXC                      | 125-250                       | 2001-2002   | OEM  | K Orange             |      | R-CVKTMAR9802  | € 56,95 |
| EXC                      | 400-520                       | 2000 > 2002 | OEM  | Black                |      | R-CVKTMRNR9802 | € 56,95 |
|                          |                               |             |  | K Orange             |      | R-CVKTMAR9802  |         |
| EXCF                     | 250                           | 2007        | OEM  | Black                |      | R-CVKTMRNR9802 | € 56,95 |
|                          |                               |             |  | K Orange             |      | R-CVKTMAR9802  |         |
| EXC                      | 125-200-250-300               | 2003-2004   | OEM  | White                |      | R-CVKTMBN0005  | € 56,95 |
|                          |                               |             |  | Black                |      | R-CVKTMRNR0005 |         |
| EXC                      | 125-200-250-300               | 2003-2004   | OEM  | K Orange             |      | R-CVKTMAR9803  | € 56,95 |
|                          |                               |             |  | Black                |      | R-CVKTMRNR9803 |         |
| EXC                      | 450-525                       | 2003-2004   | OEM  | K Orange             |      | R-CVKTMAR9803  | € 56,95 |
|                          |                               |             |  | Black                |      | R-CVKTMRNR9803 |         |
| EXC                      | 125-200-250-300-450-525       | 2005 > 2007 | OEM  | K Orange             |      | R-CVKTMAR0005  | € 56,95 |
|                          |                               |             |  | White                |      | R-CVKTMBN0005  |         |
| EXC / EXCF               | 125 > 530                     | 2008 > 2011 | OEM  | Black                |      | R-CVKTMRNR0005 | € 56,95 |
|                          |                               |             |  | K Orange             |      | R-CVKTMAR0005  |         |
| EXC / EXCF               | 125 > 530                     | 2008 > 2011 | OEM  | White                |      | R-CVKTMBN0007  | € 59,95 |
|                          |                               |             |  | Black                |      | R-CVKTMRNR0007 |         |
|                          |                               |             |  | K Orange             |      | R-CVKTMAR0007  |         |
| EXC / EXCF               | 125-250-300-250F-350F-450-500 | 2012-2013   | OEM<br>OEM Six Days  | White                |      | R-CVKTMBN0011  | € 59,95 |
|                          |                               |             |  | Black                |      | R-CVKTMRNR0011 |         |
|                          |                               |             |  | K Orange             |      | R-CVKTMAR0011  |         |
| EXC / EXCF               | 125 > 500                     | 2014 > 2016 | Bi-Color<br>OEM Six Days - Bi-Color<br>OEM 2015-2016 - Bi-Color<br>Bi-Color  | K Orange-Black       |      | R-CVKTMRNR13   | € 59,95 |
|                          |                               |             |  | White-Black          |      | R-CVKTMBNNR13  |         |
|                          |                               |             |  | White-K Orange       |      | R-CVKTMBNAR13  |         |
|                          |                               |             |  | White-Neon Orange ☀️ |      | R-CVKTMBNAN13  |         |
|                          |                               |             |  | Black                |      | R-CVKTMRNR0013 |         |
| XC-W                     | 125-150                       | 2017 > 2019 | OEM EXC/EXCF 2017-2019 and Six Days 2019<br>OEM Six Days 2017-2018 - Bi-Color<br>Bi-Color<br>Bi-Color                          | Black                |      | R-CVKTMRNR0016 | € 59,95 |
|                          |                               |             |  | White-Black          |      | R-CVKTMBNNR16  |         |
|                          |                               |             |  | K Orange-Black       |      | R-CVKTMRNR16   |         |
|                          |                               |             |  | Neon Yellow-Black ☀️ |      | R-CVKTMGFNR16  |         |
|                          |                               |             |  | K Orange             |      | R-CVKTMAR0016  |         |
|                          |                               |             |  | Neon Orange          |      | R-CVKTMAN0016  |         |
|                          |                               |             |  | Light Blue-Black     |      | R-CVKTMCCLR16  |         |
|                          |                               |             |  | White                |      | R-CVKTMBN0016  |         |
|                          |                               |             |  | Quantum Grey         |      | R-CVKTMGRO016  |         |
|                          |                               |             |  | Black                |      | R-CVKTMRNR0016 |         |
| EXC / EXCF<br>XC-W       | 250 > 500                     | 2017 > 2019 | OEM EXC/EXCF 2017-2019 and Six Days 2019<br>OEM Six Days 2017-2018 - Bi-Color<br>Bi-Color<br>Bi-Color                          | White-Black          |      | R-CVKTMBNNR16  | € 59,95 |
|                          |                               |             |  | K Orange-Black       |      | R-CVKTMRNR16   |         |
|                          |                               |             |  | Neon Yellow-Black ☀️ |      | R-CVKTMGFNR16  |         |
|                          |                               |             |  | K Orange             |      | R-CVKTMAR0016  |         |
|                          |                               |             |  | Neon Orange          |      | R-CVKTMAN0016  |         |
|                          |                               |             |  | Light Blue-Black     |      | R-CVKTMCCLR16  |         |
|                          |                               |             |  | White                |      | R-CVKTMBN0016  |         |
|                          |                               |             |  | Quantum Grey         |      | R-CVKTMGRO016  |         |
|                          |                               |             |  | Black                |      | R-CVKTMRNR0016 |         |
|                          |                               |             |  | White-Black          |      | R-CVKTMBNNR16  |         |
| EXC / EXCF<br>XC-W/XCF-W | 150-250-300-350-450-500       | 2020 > 2023 | OEM 2020 - Bi-Color<br>OEM 2021 - Bi-Color<br>OEM 2023 - Erzberg Rodeo 2021-22 - Bi-Color<br>OEM Erzberg Rodeo 2020 - Bi-Color | K Orange-Black       |      | R-CVKTMRNR19   | € 59,95 |
|                          |                               |             |  | Black-K Orange       |      | R-CVKTMRNR19   |         |
|                          |                               |             |  | White-K Orange       |      | R-CVKTMBNAR19  |         |
|                          |                               |             |  | White-Black          |      | R-CVKTMBNNR19  |         |
|                          |                               |             |  | White K-Red          |      | R-CVKTMBNRS19  |         |
|                          |                               |             |  | White                |      | R-CVKTMBN0019  |         |
|                          |                               |             |  | K Orange             |      | R-CVKTMAR0019  |         |
|                          |                               |             |  | Black                |      | R-CVKTMRNR0019 |         |
|                          |                               |             |  | Neon Yellow/Black ☀️ |      | R-CVKTMGFNR19  |         |
|                          |                               |             |  | Neon Orange ☀️       |      | R-CVKTMAN0019  |         |
|                          |                               |             |  | Light Blue           |      | R-CVKTMCLO019  |         |
|                          |                               |             |  | Quantum Grey         |      | R-CVKTMGRO019  |         |
|                          |                               |             |  | Blue-K Orange        |      | R-CVKTMBLAR19  |         |
|                          |                               |             |  | Grey 2021            |      | R-CVKTMGAA019  |         |
|                          |                               |             |  | Grey 2021-K Orange   |      | R-CVKTMGAA019  |         |
| EXC / EXCF               | 150-250-300-350-450-500       | 2020 > 2023 | OEM Six Days 2021<br>OEM 2020 > 2023<br>OEM Six Days 2020<br>Bi-Color  | Quantum Grey         |      | R-CVKTMGRO019  | € 59,95 |
|                          |                               |             |  | Black                |      | R-CVKTMRNR0019 |         |
| EXC / EXCF               | 150-250-300-350-450-500       | 2020 > 2023 | Limited Edition<br>Limited Edition   | Blue-K Orange        |      | R-CVKTMBLAR19  | € 59,95 |
|                          |                               |             |  | Grey 2021            |      | R-CVKTMGAA019  |         |
| EXC / EXCF               | 150-250-300-350-450-500       | 2020 > 2023 | Limited Edition<br>Limited Edition   | Grey 2021-K Orange   |      | R-CVKTMGAA019  | € 59,95 |
|                          |                               |             |  | Black                |      | R-CVKTMRNR0019 |         |

**OEM** original color -  fluorescent color

| MODEL           | CC  | YEAR  | NOTES  | COLOR   |   | CODE           | PRICE   |         |
|-----------------|---|---|--|---|---|----------------|---------|---------|
| XC / XC-F       | 250-300-350-450   | 2017-2018   | OEM 2017 - Bi-Color<br>OEM 2018 - Bi-Color<br>Bi-Color<br>Bi-Color<br>Bi-Color | White-Black   |  | R-CVKTMBNRR16  | € 59,95 |         |
|                 |   |   |  | K Orange-Black  |  | R-CVKTMAARNR16 |         |         |
|                 |   |   |  | Light Blue-Black  |  | R-CVKTMCNLR16  |         |         |
|                 |   |   |  | Neon Yellow-Black  |  | R-CVKTMGFNR16  |         |         |
|                 |   |   |  | Neon Orange   |  | R-CVKTMAN0016  |         |         |
|                 |   |   |  | Black   |  | R-CVKTMMNR0016 |         |         |
|                 |   |   |  | White   |  | R-CVKTMBN0016  |         |         |
|                 |   |   |  | Quantum Grey  |  | R-CVKTMGRR0016 |         |         |
|                 |   |   |  | Limited Edition   |  | R-CVKTMBNAR19  |         | € 59,95 |
|                 |   |   |  | OEM - Bi-Color  |  | R-CVKTMAARNR19 |         |         |
| Bi-Color        |                    | R-CVKTMMNRR19   |  |   |   |                |         |         |
| Bi-Color        |                    | R-CVKTMBNRR19   |  |   |   |                |         |         |
| Bi-Color        |                    | R-CVKTMBNRS19   |  |   |   |                |         |         |
|                 |                    | R-CVKTMBN0019   |  |   |   |                |         |         |
|                 |                    | R-CVKTMAR0019   |  |   |   |                |         |         |
|                 |                    | R-CVKTMMNR0019  |  |   |   |                |         |         |
| Bi-Color        | Neon Yellow/Black  |    | R-CVKTMGFNR19  |   |   |                |         |         |
|                 | Neon Orange        |    | R-CVKTMAN0019  |   |   |                |         |         |
|                 | Light Blue  |    | R-CVKTMCNLR19  |   |   |                |         |         |
| Limited Edition | Quantum Grey  |   | R-CVKTMGRR0019   |   |   |                |         |         |
| Limited Edition | Blue-K Orange   |  | R-CVKTMBLAR19  |   |   |                |         |         |
|                 | Grey 2021   |  | R-CVKTMGAA0019   |   |   |                |         |         |
|                 | Grey 2021-K Orange  |  | R-CVKTMGAAAR19   |   |   |                |         |         |



# KTM SIDE PANELS / TABELLE LATERALI PORTANUMERO



R-FIKTMCL0019



R-FIKTMGR0019

## AVAILABLE COLORS

|  |              |  |               |
|--|--------------|--|---------------|
|  | K Orange     |  | Blue Six Days |
|  | Black        |  | Vintage Green |
|  | White        |  | Neon Orange   |
|  | Light Blue   |  | Neon Yellow   |
|  | Quantum Grey |  | Grey 2021     |



R-FIKTMGF0019

**OEM** original color - fluorescent color





















| MODEL    | CC          | YEAR        | NOTES   | COLOR           | CODE | PRICE         |         |
|----------|-------------|-------------|---|-----------------|------|---------------|---------|
| SX / EXC | 400-520     | 2000 > 2002 | OEM - Side panels   | K Orange        |      | R-FIKTMAR9802 | € 57,95 |
|          |             |             |   | White           |      | R-FIKTMBN9802 |         |
|          |             |             |   | Black           |      | R-FIKTMNR9802 |         |
| SX / EXC | 125         | 1998 > 2003 | OEM - Side panels   | K Orange        |      | R-FIKTMAR9802 | € 57,95 |
|          |             |             |   | White           |      | R-FIKTMBN9802 |         |
|          |             |             |   | Black           |      | R-FIKTMNR9802 |         |
| SX       | 250         | 1998 > 2002 | OEM - Side panels   | K Orange        |      | R-FIKTMAR9802 | € 57,95 |
|          |             |             |   | White           |      | R-FIKTMBN9802 |         |
|          |             |             |   | Black           |      | R-FIKTMNR9802 |         |
| SX       | 380         | 1998 > 2001 | OEM - Side panels   | K Orange        |      | R-FIKTMAR9802 | € 57,95 |
|          |             |             |   | White           |      | R-FIKTMBN9802 |         |
|          |             |             |   | Black           |      | R-FIKTMNR9802 |         |
| SX       | 200         | 2003-2004   | OEM - Side panels   | K Orange        |      | R-FIKTMAR9802 | € 57,95 |
|          |             |             |   | White           |      | R-FIKTMBN9802 |         |
|          |             |             |   | Black           |      | R-FIKTMNR9802 |         |
| SX / EXC | 525         | 2003        | OEM - Side panels   | K Orange        |      | R-FIKTMAR9802 | € 57,95 |
|          |             |             |   | White           |      | R-FIKTMBN9802 |         |
|          |             |             |   | Black           |      | R-FIKTMNR9802 |         |
| SX       | 85          | 2018 > 2023 | OEM   | White           |      | R-FIKTMBN0185 | € 43,95 |
|          |             |             |   | K Orange        |      | R-FIKTMAR0185 |         |
|          |             |             |   | Black           |      | R-FIKTMNR0185 |         |
|          |             |             |   | Neon Yellow     |      | R-FIKTMGF0185 |         |
|          |             |             |   | Neon Orange     |      | R-FIKTMAN0185 |         |
| SX       | 125-150     | 2013 > 2015 | OEM 2013 2015 - Side panels with Airbox<br>OEM 2011-2012 - Side panels with Airbox<br>Side panels with Airbox | White           |      | R-CFKTMBN0013 | € 73,95 |
|          |             |             |   | Black           |      | R-CFKTMNR0013 |         |
|          |             |             |   | K Orange        |      | R-CFKTMAR0013 |         |
|          |             |             |   | White           |      | R-FIKTMBN0016 |         |
|          |             |             |   | Black           |      | R-FIKTMNR0016 |         |
| SX       | 125-150     | 2016 > 2018 | OEM   | K Orange        |      | R-FIKTMAR0016 | € 49,95 |
|          |             |             |   | Neon Yellow     |      | R-FIKTMGF0016 |         |
|          |             |             |   | Neon Orange     |      | R-FIKTMAN0016 |         |
|          |             |             |   | Green           |      | R-FIKTMVE0016 |         |
|          |             |             |   | Light Blue      |      | R-FIKTMCL0016 |         |
|          |             |             |   | Quantum Grey    |      | R-FIKTMGR0016 |         |
|          |             |             |   | Limited Edition |      |               |         |
|          |             |             |   | Limited Edition |      |               |         |
|          |             |             |   | Limited Edition |      |               |         |
|          |             |             |   | Limited Edition |      |               |         |
| SX       | 125-150-250 | 2019 > 2022 | OEM   | White           |      | R-FIKTMBN0019 | € 49,95 |
|          |             |             |   | Grey 2021       |      | R-FIKTMGA0021 |         |
|          |             |             |   | K Orange        |      | R-FIKTMAR0019 |         |
|          |             |             |   | Black           |      | R-FIKTMNR0019 |         |
|          |             |             |   | Neon Yellow     |      | R-FIKTMGF0019 |         |
|          |             |             |   | Neon Orange     |      | R-FIKTMAN0019 |         |
|          |             |             |   | Light Blue      |      | R-FIKTMCL0019 |         |
|          |             |             |   | Quantum Grey    |      | R-FIKTMGR0019 |         |
|          |             |             |   | Blue            |      | R-FIKTMBL0019 |         |
|          |             |             |   | Limited Edition |      |               |         |
|          |             |             |   | Limited Edition |      |               |         |
| SX       | 125-250-300 | 2023        | OEM   | White           |      | R-FIKTMBN0023 | € 34,95 |
|          |             |             |   | K Orange        |      | R-FIKTMAR0023 |         |
|          |             |             |   | Black           |      | R-FIKTMNR0023 |         |
|          |             |             |   | Neptune Blue    |      | R-FIKTMNB0023 |         |
|          |             |             |   | Neon Orange     |      | R-FIKTMAN0023 |         |
|          |             |             |   | Neon Yellow     |      | R-FIKTMGF0023 |         |
|          |             |             |   | Quantum Grey    |      | R-FIKTMGR0023 |         |
|          |             |             |   | Limited Edition |      |               |         |
| SX       | 250         | 2013 > 2016 | OEM 2013 2016 - Side panels with Airbox<br>OEM 2011-2012 - Side panels with Airbox                            | White           |      | R-CFKTMBN0013 | € 73,95 |
|          |             |             |   | Black           |      | R-CFKTMNR0013 |         |
|          |             |             |   | K Orange        |      | R-CFKTMAR0013 |         |
|          |             |             |   | K Orange        |      | R-FIKTMAR0013 |         |

**NEW**

**OEM** original color -  fluorescent color

| MODEL                                   | CC                      | YEAR        | NOTES                                     | COLOR                                     | CODE        | PRICE         |                   |                   |                    |               |               |         |   |                         |               |               |         |               |  |               |  |
|---|-------------------------|-------------|---|---|-------------|---------------|-------------------|-------------------|--------------------|---------------|---------------|---------|---|-------------------------|---------------|---------------|---------|---------------|--|---------------|--|
| <b>SX</b>                               | 250                     | 2017-2018   | OEM                                       | White                                     |             | R-FIKTMBN0016 | € 49,95           |                   |                    |               |               |         |   |                         |               |               |         |               |  |               |  |
|   |                         |             |   | Black                                     |             | R-FIKTMNR0016 |                   |                   |                    |               |               |         |   |                         |               |               |         |               |  |               |  |
|   |                         |             |   | K Orange                                  |             | R-FIKTMAR0016 |                   |                   |                    |               |               |         |   |                         |               |               |         |               |  |               |  |
|   |                         |             |   | Neon Yellow                               |             | R-FIKTMGF0016 |                   |                   |                    |               |               |         |   |                         |               |               |         |               |  |               |  |
|   |                         |             |   | Neon Orange                               |             | R-FIKTMAN0016 |                   |                   |                    |               |               |         |   |                         |               |               |         |               |  |               |  |
|   |                         |             |   | Green                                     |             | R-FIKTMVE0016 |                   |                   |                    |               |               |         |   |                         |               |               |         |               |  |               |  |
|   |                         |             |   | Light Blue                                |             | R-FIKTMCL0016 |                   |                   |                    |               |               |         |   |                         |               |               |         |               |  |               |  |
|   |                         |             |   | Quantum Grey                              |             | R-FIKTMGR0016 |                   |                   |                    |               |               |         |   |                         |               |               |         |               |  |               |  |
|   |                         |             |   | Limited Edition                           |             |               |                   | White             |                    | R-FIKTMBN0016 |               |         |   |                         |               |               |         |               |  |               |  |
|   |                         |             |   | OEM 2013 > 2015 - Side panels with Airbox |             |               |                   | Black             |                    | R-FIKTMNR0016 |               |         |   |                         |               |               |         |               |  |               |  |
| OEM 2011-2012 - Side panels with Airbox |                         |             |   | K Orange                                  |             | R-CFKTMAR0013 |                   |                   |                    |               |               |         |   |                         |               |               |         |               |  |               |  |
| Side panels with Airbox                 |                         |             |   | White                                     |             | R-FIKTMBN0016 |                   |                   |                    |               |               |         |   |                         |               |               |         |               |  |               |  |
| <b>SXF</b>                              | 250-350-450             | 2013 > 2015 | OEM 2013 > 2015 - Side panels with Airbox | White                                     |             | R-CFKTMBN0013 | € 73,95           |                   |                    |               |               |         |   |                         |               |               |         |               |  |               |  |
|   |                         |             |   | Black                                     |             | R-CFKTMNR0013 |                   |                   |                    |               |               |         |   |                         |               |               |         |               |  |               |  |
|   |                         |             |   | K Orange                                  |             | R-CFKTMAR0013 |                   |                   |                    |               |               |         |   |                         |               |               |         |               |  |               |  |
|   |                         |             |   | OEM 2016 > 2018                           |             |               |                   | White             |                    | R-FIKTMBN0016 |               |         |   |                         |               |               |         |               |  |               |  |
|   |                         |             |   | OEM                                       |             |               |                   | Black             |                    | R-FIKTMNR0016 |               |         |   |                         |               |               |         |               |  |               |  |
|   |                         |             |   |   |             |               |                   | K Orange          |                    | R-FIKTMAR0016 |               |         |   |                         |               |               |         |               |  |               |  |
|   |                         |             |   |   |             |               |                   | Neon Yellow       |                    | R-FIKTMGF0016 |               |         |   |                         |               |               |         |               |  |               |  |
|   |                         |             |   |   |             |               |                   | Neon Orange       |                    | R-FIKTMAN0016 |               |         |   |                         |               |               |         |               |  |               |  |
|   |                         |             |   |   |             |               |                   | Green             |                    | R-FIKTMVE0016 |               |         |   |                         |               |               |         |               |  |               |  |
|   |                         |             |   |   |             |               |                   | Light Blue        |                    | R-FIKTMCL0016 |               |         |   |                         |               |               |         |               |  |               |  |
| <b>SXF</b>                              | 250-350-450             | 2016 > 2018 | OEM                                       | Quantum Grey                              |             | R-FIKTMGR0016 | € 49,95           |                   |                    |               |               |         |   |                         |               |               |         |               |  |               |  |
|   |                         |             |   | Limited Edition                           |             |               |                   | White             |                    | R-FIKTMBN0019 |               |         |   |                         |               |               |         |               |  |               |  |
|   |                         |             |   | OEM                                       |             |               |                   | Grey 2021         |                    | R-FIKTMGA0021 |               |         |   |                         |               |               |         |               |  |               |  |
|   |                         |             |   |   |             |               |                   | K Orange          |                    | R-FIKTMAR0019 |               |         |   |                         |               |               |         |               |  |               |  |
|   |                         |             |   |   |             |               |                   | Black             |                    | R-FIKTMNR0019 |               |         |   |                         |               |               |         |               |  |               |  |
|   |                         |             |   |   |             |               |                   | Neon Yellow       |                    | R-FIKTMGF0019 |               |         |   |                         |               |               |         |               |  |               |  |
|   |                         |             |   |   |             |               |                   | Neon Orange       |                    | R-FIKTMAN0019 |               |         |   |                         |               |               |         |               |  |               |  |
|   |                         |             |   |   |             |               |                   | Light Blue        |                    | R-FIKTMCL0019 |               |         |   |                         |               |               |         |               |  |               |  |
|   |                         |             |   |   |             |               |                   | Quantum Grey      |                    | R-FIKTMGR0019 |               |         |   |                         |               |               |         |               |  |               |  |
|   |                         |             |   |   |             |               |                   | Blue              |                    | R-FIKTMBL0019 |               |         |   |                         |               |               |         |               |  |               |  |
| <b>SXF</b>                              | 250-350-450             | 2019 > 2022 | OEM                                       | White                                     |             | R-FIKTMBN0019 | € 54,95           |                   |                    |               |               |         |   |                         |               |               |         |               |  |               |  |
|   |                         |             |   | Limited Edition                           |             |               |                   | Grey 2021         |                    | R-FIKTMGA0021 |               |         |   |                         |               |               |         |               |  |               |  |
|   |                         |             |   |   |             |               |                   | K Orange          |                    | R-FIKTMAR0019 |               |         |   |                         |               |               |         |               |  |               |  |
|   |                         |             |   |   |             |               |                   | Black             |                    | R-FIKTMNR0019 |               |         |   |                         |               |               |         |               |  |               |  |
|   |                         |             |   |   |             |               |                   | Neon Yellow       |                    | R-FIKTMGF0019 |               |         |   |                         |               |               |         |               |  |               |  |
|   |                         |             |   |   |             |               |                   | Neon Orange       |                    | R-FIKTMAN0019 |               |         |   |                         |               |               |         |               |  |               |  |
|   |                         |             |   |   |             |               |                   | Light Blue        |                    | R-FIKTMCL0019 |               |         |   |                         |               |               |         |               |  |               |  |
|   |                         |             |   |   |             |               |                   | Quantum Grey      |                    | R-FIKTMGR0019 |               |         |   |                         |               |               |         |               |  |               |  |
|   |                         |             |   |   |             |               |                   | Blue              |                    | R-FIKTMBL0019 |               |         |   |                         |               |               |         |               |  |               |  |
|   |                         |             |   | <b>SXF</b>                                | 250-350-450 | 2023          |                   | OEM               | White              |               | R-FIKTMBN0023 | € 49,95 |   |                         |               |               |         |               |  |               |  |
|   |                         |             |   |   |             |               | K Orange          |                   |                    | R-FIKTMAR0023 |               |         |   |                         |               |               |         |               |  |               |  |
|   |                         |             |   |   |             |               | Black             |                   |                    | R-FIKTMNR0023 |               |         |   |                         |               |               |         |               |  |               |  |
|   |                         |             |   |   |             |               | Neptune Blue      |                   |                    | R-FIKTMNB0023 |               |         |   |                         |               |               |         |               |  |               |  |
|   |                         |             |   |   |             |               | Neon Orange       |                   |                    | R-FIKTMAN0023 |               |         |   |                         |               |               |         |               |  |               |  |
|   |                         |             |   |   |             |               | Neon Yellow       |                   |                    | R-FIKTMGF0023 |               |         |   |                         |               |               |         |               |  |               |  |
|   |                         |             |   |   |             |               | Quantum Grey      |                   |                    | R-FIKTMGR0023 |               |         |   |                         |               |               |         |               |  |               |  |
|   |                         |             |   |   |             |               | White             |                   |                    | R-FIKTMBN0019 |               |         |   |                         |               |               |         |               |  |               |  |
|   |                         |             |   |   |             |               | K Orange          |                   |                    | R-FIKTMAR0019 |               |         |   |                         |               |               |         |               |  |               |  |
|   |                         |             |   |   |             |               | Grey 2021         |                   |                    | R-FIKTMGA0021 |               |         |   |                         |               |               |         |               |  |               |  |
| <b>SXF</b>                              | 250-450 Factory Edition | 2018 > 2021 | OEM Factory Edition                       | Black                                     |             | R-FIKTMNR0019 | € 54,95           |                   |                    |               |               |         |   |                         |               |               |         |               |  |               |  |
|   |                         |             |   |   |             |               |                   | Neon Yellow       |                    | R-FIKTMGF0019 |               |         |   |                         |               |               |         |               |  |               |  |
|   |                         |             |   |   |             |               |                   | Neon Orange       |                    | R-FIKTMAN0019 |               |         |   |                         |               |               |         |               |  |               |  |
|   |                         |             |   |   |             |               |                   | Light Blue        |                    | R-FIKTMCL0019 |               |         |   |                         |               |               |         |               |  |               |  |
|   |                         |             |   |   |             |               |                   | Quantum Grey      |                    | R-FIKTMGR0019 |               |         |   |                         |               |               |         |               |  |               |  |
|   |                         |             |   |   |             |               |                   | Blue              |                    | R-FIKTMBL0019 |               |         |   |                         |               |               |         |               |  |               |  |
|   |                         |             |   | Limited Edition                           |             |               |                   | White             |                    | R-FIKTMBN0023 |               |         |   |                         |               |               |         |               |  |               |  |
|   |                         |             |   |   |             |               |                   | K Orange          |                    | R-FIKTMAR0023 |               |         |   |                         |               |               |         |               |  |               |  |
|   |                         |             |   |   |             |               |                   | Black             |                    | R-FIKTMNR0023 |               |         |   |                         |               |               |         |               |  |               |  |
|   |                         |             |   |   |             |               |                   | Neptune Blue      |                    | R-FIKTMNB0023 |               |         |   |                         |               |               |         |               |  |               |  |
| <b>SXF</b>                              | 250-450 Factory Edition | 2022        | OEM                                       | Neon Orange                               |             | R-FIKTMAN0023 | € 49,95           |                   |                    |               |               |         |   |                         |               |               |         |               |  |               |  |
|   |                         |             |   |   |             |               |                   | Neon Yellow       |                    | R-FIKTMGF0023 |               |         |   |                         |               |               |         |               |  |               |  |
|   |                         |             |   |   |             |               |                   | Quantum Grey      |                    | R-FIKTMGR0023 |               |         |   |                         |               |               |         |               |  |               |  |
|   |                         |             |   |   |             |               |                   | White             |                    | R-FIKTMBN0019 |               |         |   |                         |               |               |         |               |  |               |  |
|   |                         |             |   |   |             |               |                   | K Orange          |                    | R-FIKTMAR0019 |               |         |   |                         |               |               |         |               |  |               |  |
|   |                         |             |   |   |             |               |                   | Grey 2021         |                    | R-FIKTMGA0021 |               |         |   |                         |               |               |         |               |  |               |  |
|   |                         |             |   |   |             |               |                   | Black             |                    | R-FIKTMNR0019 |               |         |   |                         |               |               |         |               |  |               |  |
|   |                         |             |   |   |             |               |                   | Neon Yellow       |                    | R-FIKTMGF0019 |               |         |   |                         |               |               |         |               |  |               |  |
|   |                         |             |   |   |             |               |                   | Neon Orange       |                    | R-FIKTMAN0019 |               |         |   |                         |               |               |         |               |  |               |  |
|   |                         |             |   |   |             |               |                   | Light Blue        |                    | R-FIKTMCL0019 |               |         |   |                         |               |               |         |               |  |               |  |
| <b>EXC</b>                              | 250                     | 1998 > 2003 | OEM - Side panels                         | Quantum Grey                              |             | R-FIKTMGR0023 | € 57,95           |                   |                    |               |               |         |   |                         |               |               |         |               |  |               |  |
|   |                         |             |   |   |             |               |                   | White             |                    | R-FIKTMBN9802 |               |         |   |                         |               |               |         |               |  |               |  |
|   |                         |             |   |   |             |               |                   | Black             |                    | R-FIKTMNR9802 |               |         |   |                         |               |               |         |               |  |               |  |
|   |                         |             |   |   |             |               |                   | K Orange          |                    | R-FIKTMAR9802 |               |         |   |                         |               |               |         |               |  |               |  |
|   |                         |             |   | <b>EXC</b>                                | 200-300-450 | 2003          |                   | OEM - Side panels | White              |               | R-FIKTMBN9802 | € 57,95 |   |                         |               |               |         |               |  |               |  |
|   |                         |             |   |   |             |               |                   |                   |                    |               |               |         | Black                                     |                         | R-FIKTMNR9802 |               |         |               |  |               |  |
|   |                         |             |   |   |             |               |                   |                   |                    |               |               |         | K Orange                                  |                         | R-FIKTMAR9802 |               |         |               |  |               |  |
|   |                         |             |   |   |             |               |                   |                   | <b>EXC / EXC-F</b> | 125 > 500     | 2012 > 2016   |         | OEM 2013 > 2016 - Side panels with Airbox | White                   |               | R-CFKTMBN0013 | € 73,95 |               |  |               |  |
|   |                         |             |   |   |             |               |                   |                   |                    |               |               |         |   | Side panels with Airbox |               |               |         | K Orange      |  | R-CFKTMAR0013 |  |
|   |                         |             |   |   |             |               |                   |                   |                    |               |               |         |   | Side panels with Airbox |               |               |         | Black         |  | R-CFKTMNR0013 |  |
| Side panels with Airbox                 |                         |             |   |   |             |               | White             |                   |                    |               |               |         |   |                         | R-FIKTMBN0016 |               |         |               |  |               |  |
| <b>EXC / EXC-F XC-W</b>                 | 125 > 500               | 2017 > 2019 | OEM 2018                                  |   |             |               | Black             |                   |                    |               |               |         |   |                         | R-FIKTMNR0016 | € 57,95       |         |               |  |               |  |
|   |                         |             |   |   |             |               | OEM 2017 and 2019 |                   |                    |               |               |         |   | K Orange                |               |               |         | R-FIKTMAR0016 |  |               |  |
|   |                         |             |   |   |             |               |                   |                   |                    |               |               |         |   | Neon Yellow             |               |               |         | R-FIKTMGF0016 |  |               |  |
|   |                         |             |   |   |             |               |                   | Neon Orange       |                    |               |               |         |   | R-FIKTMAN0016           |               |               |         |               |  |               |  |
|   |                         |             |   |   |             |               |                   | Green             |                    |               |               |         |   | R-FIKTMVE0016           |               |               |         |               |  |               |  |
|   |                         |             |   |   |             |               |                   | Light Blue        |                    |               |               |         |   | R-FIKTMCL0016           |               |               |         |               |  |               |  |
|   |                         |             |   |   |             |               |                   | Quantum Grey      |                    | R-FIKTMGR0016 |               |         |   |                         |               |               |         |               |  |               |  |
|   |                         |             |   | Limited Edition                           |             |               |                   | White             |                    | R-FIKTMBN0019 |               |         |   |                         |               |               |         |               |  |               |  |
|   |                         |             |   | OEM Six Days 2021 / Erzberg Rodeo 2020    |             |               |                   | K Orange          |                    | R-FIKTMAR0019 |               |         |   |                         |               |               |         |               |  |               |  |
|   |                         |             |   | OEM 2020-2021 and 2023                    |             |               |                   | Grey 2021         |                    | R-FIKTMGA0021 |               |         |   |                         |               |               |         |               |  |               |  |
| <b>EXC / EXC-F XC-W/XCF-W</b>           | 150 > 500               | 2020 > 2023 | OEM 2021                                  | Black                                     |             | R-FIKTMNR0019 | € 54,95           |                   |                    |               |               |         |   |                         |               |               |         |               |  |               |  |
|   |                         |             |   |   |             |               |                   | Neon Yellow       |                    | R-FIKTMGF0019 |               |         |   |                         |               |               |         |               |  |               |  |
|   |                         |             |   |   |             |               |                   | Neon Orange       |                    | R-FIKTMAN0019 |               |         |   |                         |               |               |         |               |  |               |  |
|   |                         |             |   |   |             |               |                   | Light Blue        |                    | R-FIKTMCL0019 |               |         |   |                         |               |               |         |               |  |               |  |
|   |                         |             |   |   |             |               |                   | Quantum Grey      |                    | R-FIKTMGR0019 |               |         |   |                         |               |               |         |               |  |               |  |
|   |                         |             |   |   |             |               |                   | Blue              |                    | R-FIKTMBL0019 |               |         |   |                         |               |               |         |               |  |               |  |
|   |                         |             |   | Limited Edition                           |             |               |                   | White             |                    | R-FIKTMBN0019 |               |         |   |                         |               |               |         |               |  |               |  |
|   |                         |             |   |   |             |               |                   | K Orange          |                    | R-FIKTMAR0019 |               |         |   |                         |               |               |         |               |  |               |  |
|   |                         |             |   |   |             |               |                   | Grey 2021         |                    | R-FIKTMGA0021 |               |         |   |                         |               |               |         |               |  |               |  |
|   |                         |             |   |   |             |               |                   | Black             |                    | R-FIKTMNR0019 |               |         |   |                         |               |               |         |               |  |               |  |

## KTM SIDE PANELS / TABELLE LATERALI PORTANUMERO

| MODEL           | CC  | YEAR          | NOTES | COLOR           | CODE  | PRICE         |         |     |
|-----------------|---|---------------|-------|-----------------|---|---------------|---------|-----|
| XC / XC-F       | 250-300-350-450   | 2017-2018     | OEM   | White           |  | R-FIKTMBN0016 | € 57,95 |     |
|                 |   |               |       | Neon Orange     |  | R-FIKTMAN0016 |         |     |
|                 |   |               |       | K Orange        |  | R-FIKTMAR0016 |         |     |
|                 |   |               |       | Neon Yellow     |  | R-FIKTMGF0016 |         |     |
|                 |   |               |       | Black           |  | R-FIKTMNR0016 |         |     |
|                 |   |               |       | Green           |  | R-FIKTMVE0016 |         |     |
|                 |   |               |       | Light Blue      |  | R-FIKTMCL0016 |         |     |
|                 |   |               |       | Quantum Grey    |  | R-FIKTMGR0016 |         |     |
|                 |   |               |       | Limited Edition |   |               |         |     |
|                 |   |               |       | XC / XC-F       | 250-300-350-450   | 2019 > 2022   |         | OEM |
| K Orange        |  | R-FIKTMAR0019 |       |                 |   |               |         |     |
| Grey 2021       |  | R-FIKTMGA0021 |       |                 |   |               |         |     |
| Black           |  | R-FIKTMNR0019 |       |                 |   |               |         |     |
| Neon Yellow     |  | R-FIKTMGF0019 |       |                 |   |               |         |     |
| Neon Orange     |  | R-FIKTMAN0019 |       |                 |   |               |         |     |
| Light Blue      |  | R-FIKTMCL0019 |       |                 |   |               |         |     |
| Quantum Grey    |  | R-FIKTMGR0019 |       |                 |   |               |         |     |
| Limited Edition |   |               |       |                 |   |               |         |     |
| XC / XC-F       | 125-250-300-350-450   | 2023          | OEM   |                 |   |               | White   |     |
|                 |   |               |       | K Orange        |  | R-FIKTMAR0023 |         |     |
|                 |   |               |       | Black           |  | R-FIKTMNR0023 |         |     |
|                 |   |               |       | Neptune Blue    |  | R-FIKTMNB0023 |         |     |
|                 |   |               |       | Neon Orange     |  | R-FIKTMAN0023 |         |     |
|                 |   |               |       | Neon Yellow     |  | R-FIKTMGF0023 |         |     |
|                 |   |               |       | Quantum Grey    |  | R-FIKTMGR0023 |         |     |
|                 |   |               |       | <b>NEW</b>      |   |               |         |     |





R-FIKTMANSX99



R-FIKTMGRSX19

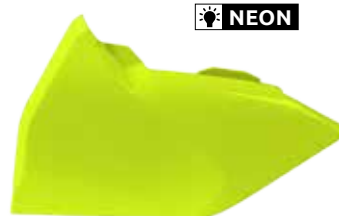

R-FIKTMGFSX16



## AVAILABLE COLORS

- K Orange
- Blue Six Days
- Black
- Vintage Green
- White
- Neon Orange
- Light Blue
- Neon Yellow
- Quantum Grey
- Grey 2021

**OEM** original color - fluorescent color

| MODEL                  | CC                        | YEAR        | NOTES                                     | COLOR             |  | CODE            | PRICE   |
|------------------------|---------------------------|-------------|---|-------------------|--|-----------------|---------|
| SX                     | 85                        | 2013 > 2017 | OEM Bi-Color 2017                         | White-Black       |  | R-FIKTMBNNRSX85 | € 27,95 |
|                        |                           |             | OEM Bi-Color 2015-2016 - left             | White-K Orange    |  | R-FIKTMBNARSX85 |         |
|                        |                           |             | left                                      | White             |  | R-FIKTMBNSX85   |         |
|                        |                           |             | left                                      | Black             |  | R-FIKTMNRSX85   |         |
| SX                     | 85                        | 2018 > 2023 | OEM - left                                | White             |  | R-FIKTMBNSX185  | € 23,95 |
|                        |                           |             | left                                      | K Orange          |  | R-FIKTMARSX185  |         |
|                        |                           |             | left                                      | Black             |  | R-FIKTMNRSX185  |         |
|                        |                           |             | left                                      | Neon Yellow       |  | R-FIKTMGFSX185  |         |
|                        |                           |             | left                                      | Neon Orange       |  | R-FIKTMANSX185  |         |
| left                   | Light Blue                |             | R-FIKTMCLSX185                            |                   |  |                 |         |
| SX                     | 125-144-150-250           | 2007 > 2010 | OEM SX/SXF/EXC 2008 > 2010 - right        | Black             |  | R-FIKTMNRDX07   | € 47,95 |
|                        |                           |             | OEM SX/SXF 2007 - right                   | K Orange          |  | R-FIKTMARDX07   |         |
|                        |                           |             | right                                     | White             |  | R-FIKTMBNDX07   |         |
| SXF                    | 250-450-505               | 2007 > 2010 | OEM SX/SXF/EXC 2008 > 2010 - right        | Black             |  | R-FIKTMNRDX07   | € 47,95 |
|                        |                           |             | OEM SX/SXF 2007 - right                   | K Orange          |  | R-FIKTMARDX07   |         |
| right                  | White                     |             | R-FIKTMBNDX07                             |                   |  |                 |         |
| SX                     | 125-144-150-250           | 2007 > 2010 | OEM SX/SXF 2008 > 2010 - EXC 2008 > 2011  | Black             |  | R-FIKTMNRSX07   | € 31,95 |
|                        |                           |             | left                                      | K Orange          |  | R-FIKTMARSX07   |         |
| left                   | White                     |             | R-FIKTMBNSX07                             |                   |  |                 |         |
| SXF                    | 250-450-505               | 2007 > 2010 | OEM SX/SXF 2008>2010 - EXC 2008>2011 left | Black             |  | R-FIKTMNRSX07   | € 31,95 |
|                        |                           |             | OEM SX/SXF 2007 - left                    | K Orange          |  | R-FIKTMARSX07   |         |
|                        |                           |             | left                                      | White             |  | R-FIKTMBNSX07   |         |
| SX                     | 125-150-250               | 2011        | OEM - right                               | K Orange          |  | R-FIKTMARDX2T   | € 23,95 |
|                        |                           |             | OEM Six Days - right                      | White             |  | R-FIKTMBNDX2T   |         |
|                        |                           |             | right                                     | Black             |  | R-FIKTMNRDX2T   |         |
| SX                     | 125-250                   | 2012        | OEM - right                               | K Orange          |  | R-FIKTMARDX4T   | € 23,95 |
|                        |                           |             | right                                     | White             |  | R-FIKTMBNDX4T   |         |
|                        |                           |             | right                                     | Black             |  | R-FIKTMNRDX4T   |         |
| SXF                    | 250F-350F-450             | 2011-2012   | OEM - right                               | K Orange          |  | R-FIKTMARDX4T   | € 23,95 |
|                        |                           |             | right                                     | White             |  | R-FIKTMBNDX4T   |         |
|                        |                           |             | right                                     | Black             |  | R-FIKTMNRDX4T   |         |
| SX / SXF               | 125-150-250-250F-350F-450 | 2011-2012   | OEM - left Bi-Color                       | K Orange-Black    |  | R-FIKTMARSX11   | € 27,95 |
|                        |                           |             | left Bi-Color White/Black                 | White-Black       |  | R-FIKTMBNSX11   |         |
|                        |                           |             | left                                      | Black             |  | R-FIKTMNRSX11   |         |
| SX                     | 125                       | 2013 > 2015 | OEM 2015 Bi-Color - right                 | White-K Orange    |  | R-FIKTMBNARDX13 | € 27,95 |
|                        |                           |             | OEM 2013-2014 Bi-Color - right            | K Orange-Black    |  | R-FIKTMARDX13   |         |
|                        |                           |             | right Bi-Color                            | White-Black       |  | R-FIKTMBNDX13   |         |
|                        |                           |             | right                                     | Black             |  | R-FIKTMNRDX13   |         |
| SX                     | 125                       | 2013 > 2015 | OEM 2015 Bi-Color                         | White-K Orange    |  | R-FIKTMBNARSX13 | € 27,95 |
|                        |                           |             | OEM 2013-2014 Bi-Color - left             | K Orange-Black    |  | R-FIKTMARSX13   |         |
|                        |                           |             | left Bi-Color                             | White-Black       |  | R-FIKTMBNSX13   |         |
|                        |                           |             | left                                      | Black             |  | R-FIKTMNRSX13   |         |
|                        |                           |             | left Bi-Color                             | White-Neon Orange |  | R-FIKTMBNANSX13 |         |
| SX                     | 125-150                   | 2016 > 2018 | OEM - left                                | White             |  | R-FIKTMBNSX16   | € 25,95 |
|                        |                           |             | left                                      | K Orange          |  | R-FIKTMARSX16   |         |
|                        |                           |             | left                                      | Black             |  | R-FIKTMNRSX16   |         |
|                        |                           |             | left                                      | Neon Yellow       |  | R-FIKTMGFSX16   |         |
|                        |                           |             | left                                      | Neon Orange       |  | R-FIKTMANSX16   |         |
|                        |                           |             | left                                      | Green             |  | R-FIKTMVESX16   |         |
|                        |                           |             | left                                      | Light Blue        |  | R-FIKTMCLSX16   |         |
| left - Limited Edition | Quantum Grey              |             | R-FIKTMGRSX16                             |                   |  |                 |         |

















































































# KTM AIR BOX COVER / COPERCHIO LATERALE CASSA FILTRO

OEM original color - ☀️ fluorescent color

| MODEL | CC                  | YEAR        | NOTES                          | COLOR                    | CODE         | PRICE           |         |               |               |
|-------|---------------------|-------------|--------------------------------|--------------------------|--------------|-----------------|---------|---------------|---------------|
| SX    | 125-150-250         | 2019 > 2022 | OEM - left                     | White                    |              | R-FIKTMBNSX19   | € 25,95 |               |               |
|       |                     |             | left                           | K Orange                 |              | R-FIKTMARSX19   |         |               |               |
|       |                     |             | left                           | Grey 2021                |              | R-FIKTMGASX21   |         |               |               |
|       |                     |             | left                           | Black                    |              | R-FIKTMNRSX19   |         |               |               |
|       |                     |             | left                           | Neon Yellow              |              | R-FIKTMGFSX19   |         |               |               |
|       |                     |             | left                           | Neon Orange              |              | R-FIKTMANSX19   |         |               |               |
|       |                     |             | left                           | Light Blue               |              | R-FIKTMCLSX19   |         |               |               |
| SX    | 125-150-250         | 2019 > 2022 | left - OEM                     | White                    |              | R-FIKTMBNSX99   | € 25,95 |               |               |
|       |                     |             | vented airbox side panel       | left                     | K Orange     |                 |         | R-FIKTMARSX99 |               |
|       |                     |             | left                           | Grey 2021                |              | R-FIKTMGASX00   |         |               |               |
|       |                     |             | left                           | Black                    |              | R-FIKTMNRSX99   |         |               |               |
|       |                     |             | left                           | Neon Yellow              |              | R-FIKTMGFSX99   |         |               |               |
|       |                     |             | left                           | Neon Orange              |              | R-FIKTMANSX99   |         |               |               |
|       |                     |             | left                           | Light Blue               |              | R-FIKTMCLSX99   |         |               |               |
| SX    | 125-250-300         | 2023        | left - OEM                     | White                    |              | R-FIKTMBNSX23   | € 22,95 |               |               |
|       |                     |             | NEW                            | left                     | K Orange     |                 |         | R-FIKTMARSX23 |               |
|       |                     |             |                                | left                     | Black        |                 |         | R-FIKTMNRSX23 |               |
|       |                     |             |                                | left                     | Neptune Blue |                 |         | R-FIKTMNBSX23 |               |
|       |                     |             |                                | left                     | Neon Orange  |                 |         | R-FIKTMANSX23 |               |
|       |                     |             |                                | left                     | Neon Yellow  |                 |         | R-FIKTMGFSX23 |               |
|       |                     |             |                                | left                     | Quantum Grey |                 |         | R-FIKTMGRSX23 |               |
| SX    | 125-250-300         | 2023        | left - OEM                     | White                    |              | R-FIKTMBNSX93   | € 22,95 |               |               |
|       |                     |             | NEW                            | vented airbox side panel | left         | K Orange        |         |               | R-FIKTMARSX93 |
|       |                     |             |                                | left                     | Black        |                 |         | R-FIKTMNRSX93 |               |
|       |                     |             |                                | left                     | Neptune Blue |                 |         | R-FIKTMNBSX93 |               |
|       |                     |             |                                | left                     | Neon Orange  |                 |         | R-FIKTMANSX93 |               |
|       |                     |             |                                | left                     | Neon Yellow  |                 |         | R-FIKTMGFSX93 |               |
|       |                     |             |                                | left                     | Quantum Grey |                 |         | R-FIKTMGRSX93 |               |
| SX    | 250                 | 2013 > 2016 | OEM 2016 - right Bi-Color      | White-Black              |              | R-FIKTMBNDX13   | € 27,95 |               |               |
|       |                     |             | OEM 2015 - right Bi-Color      | White-K Orange           |              | R-FIKTMBNARDX13 |         |               |               |
|       |                     |             | OEM Bi-Color 2013-2014 - right | K Orange-Black           |              | R-FIKTMARDX13   |         |               |               |
|       |                     |             | right                          | Black                    |              | R-FIKTMNRDX13   |         |               |               |
| SX    | 250                 | 2013 > 2016 | OEM 2016 - Bi-Color - left     | White-Black              |              | R-FIKTMBNSX13   | € 27,95 |               |               |
|       |                     |             | OEM 2015 Bi-Color - left       | White-K Orange           |              | R-FIKTMBNARSX13 |         |               |               |
|       |                     |             | OEM 2013-2014 Bi-Color - left  | K Orange-Black           |              | R-FIKTMARSX13   |         |               |               |
|       |                     |             | left                           | Black                    |              | R-FIKTMNRSX13   |         |               |               |
| SX    | 250                 | 2017-2018   | OEM - left                     | White-Neon Orange        |              | R-FIKTMBNANSX13 | € 25,95 |               |               |
|       |                     |             | left                           | White                    |              | R-FIKTMBNSX16   |         |               |               |
|       |                     |             | left                           | K Orange                 |              | R-FIKTMARSX16   |         |               |               |
|       |                     |             | left                           | Black                    |              | R-FIKTMNRSX16   |         |               |               |
| SXF   | 125-150-250-350-450 | 2013 > 2015 | OEM 2015 Bi-Color - right      | White-K Orange           |              | R-FIKTMBNARDX13 | € 27,95 |               |               |
|       |                     |             | OEM 2013-2014 Bi-Color - right | K Orange-Black           |              | R-FIKTMARDX13   |         |               |               |
|       |                     |             | Bi-Color - right               | White-Black              |              | R-FIKTMBNDX13   |         |               |               |
|       |                     |             | right                          | Black                    |              | R-FIKTMNRDX13   |         |               |               |
|       |                     |             | OEM 2015 Bi-Color - left       | White-K Orange           |              | R-FIKTMBNARSX13 |         |               |               |
|       |                     |             | OEM 2013-2014 Bi-Color - left  | K Orange-Black           |              | R-FIKTMARSX13   |         |               |               |
|       |                     |             | left                           | White-Black              |              | R-FIKTMBNSX13   |         |               |               |
| SXF   | 125-150-250-350-450 | 2013 > 2015 | left                           | White-Neon Orange        |              | R-FIKTMBNANSX13 | € 27,95 |               |               |
|       |                     |             | left                           | White                    |              | R-FIKTMBNSX16   |         |               |               |
|       |                     |             | left                           | K Orange                 |              | R-FIKTMARSX16   |         |               |               |
|       |                     |             | left                           | Black                    |              | R-FIKTMNRSX16   |         |               |               |
|       |                     |             | left                           | Neon Yellow              |              | R-FIKTMGFSX16   |         |               |               |
|       |                     |             | left                           | Neon Orange              |              | R-FIKTMANSX16   |         |               |               |
|       |                     |             | left                           | Green                    |              | R-FIKTMVESX16   |         |               |               |
| SXF   | 250-350-450         | 2016 > 2018 | OEM - left                     | White                    |              | R-FIKTMBNSX16   | € 25,95 |               |               |
|       |                     |             | left                           | K Orange                 |              | R-FIKTMARSX16   |         |               |               |
|       |                     |             | left                           | Black                    |              | R-FIKTMNRSX16   |         |               |               |
|       |                     |             | left                           | Neon Yellow              |              | R-FIKTMGFSX16   |         |               |               |
|       |                     |             | left                           | Neon Orange              |              | R-FIKTMANSX16   |         |               |               |
|       |                     |             | left                           | Green                    |              | R-FIKTMVESX16   |         |               |               |
|       |                     |             | left                           | Light Blue               |              | R-FIKTMCLSX16   |         |               |               |
| SX-F  | 250-350-450         | 2019 > 2022 | left - Limited Edition         | Quantum Grey             |              | R-FIKTMGRSX16   | € 25,95 |               |               |
|       |                     |             | OEM - left                     | White                    |              | R-FIKTMBNSX19   |         |               |               |
|       |                     |             | left                           | K Orange                 |              | R-FIKTMARSX19   |         |               |               |
|       |                     |             | left                           | Grey 2021                |              | R-FIKTMGASX21   |         |               |               |
|       |                     |             | left                           | Black                    |              | R-FIKTMNRSX19   |         |               |               |
|       |                     |             | left                           | Neon Yellow              |              | R-FIKTMGFSX19   |         |               |               |
|       |                     |             | left                           | Neon Orange              |              | R-FIKTMANSX19   |         |               |               |
| left  | Light Blue          |             | R-FIKTMCLSX19                  |                          |              |                 |         |               |               |
| left  | Quantum Grey        |             | R-FIKTMGRSX19                  |                          |              |                 |         |               |               |
| left  | Blue                |             | R-FIKTMBSX19                   |                          |              |                 |         |               |               |



















# KTM AIR BOX COVER / COPERCHIO LATERALI CASSA FILTRO

**OEM** original color -  fluorescent color

| MODEL                                   | CC  | YEAR  | NOTES                                     | COLOR   | CODE  | PRICE           |         |
|---|---|---|---|---|---|-----------------|---------|
| <b>SX-F</b><br>vented airbox side panel | 250-350-450   | 2019 > 2022   | left - OEM                                | White   |    | R-FIKTMBNSX99   | € 25,95 |
|   |   |   | left                                      | K Orange  |    | R-FIKTMARSX99   |         |
|   |   |   | left                                      | Grey 2021   |    | R-FIKTMGASX00   |         |
|   |   |   | left                                      | Black   |    | R-FIKTMNRSX99   |         |
|   |   |   | left                                      | Neon Yellow          |    | R-FIKTMGFSX99   |         |
|   |   |   | left                                      | Neon Orange          |    | R-FIKTMANSX99   |         |
|   |   |   | left                                      | Light Blue  |    | R-FIKTMCLSX99   |         |
|   |   |   | left - Limited Edition                    | Quantum Grey  |    | R-FIKTMGRSX99   |         |
| left                                    | Blue  |    | R-FIKTMBLSX99                             |   |   |                 |         |
| <b>SX-F</b><br>vented airbox side panel | 250-350-450   | 2023  | left - OEM                                | White   |    | R-FIKTMBNSX23   | € 22,95 |
|   |   |   | left                                      | K Orange  |    | R-FIKTMARSX23   |         |
|   |   |   | left                                      | Black   |    | R-FIKTMNRSX23   |         |
|   |   |   | left                                      | Neptune Blue  |    | R-FIKTMNBSX23   |         |
|   |   |   | left                                      | Neon Orange          |    | R-FIKTMANSX23   |         |
|   |   |   | left                                      | Neon Yellow          |    | R-FIKTMGFSX23   |         |
|   |   |   | left                                      | Quantum Grey  |    | R-FIKTMGRSX23   |         |
|   |   |   | left - OEM                                | White   |    | R-FIKTMBNSX93   |         |
| left                                    | K Orange  |    | R-FIKTMARSX93                             |   |   |                 |         |
| left                                    | Black   |    | R-FIKTMNRSX93                             |   |   |                 |         |
| left                                    | Neptune Blue  |    | R-FIKTMNBSX93                             |   |   |                 |         |
| left                                    | Neon Orange    |    | R-FIKTMANSX93                             |   |   |                 |         |
| left                                    | Neon Yellow    |    | R-FIKTMGFSX93                             |   |   |                 |         |
| left                                    | Quantum Grey  |    | R-FIKTMGRSX93                             |   |   |                 |         |
| <b>SX-F</b><br>vented airbox side panel | 250-450 Factory Edition   | 2018 > 2021   | OEM - left                                | White   |    | R-FIKTMBNSX19   | € 25,95 |
|   |   |   | left                                      | K Orange  |    | R-FIKTMARSX19   |         |
|   |   |   | left                                      | Grey 2021   |  | R-FIKTMGASX21   |         |
|   |   |   | left                                      | Black   |  | R-FIKTMNRSX19   |         |
|   |   |   | left                                      | Neon Yellow        |  | R-FIKTMGFSX19   |         |
|   |   |   | left                                      | Neon Orange        |  | R-FIKTMANSX19   |         |
|   |   |   | left                                      | Light Blue  |  | R-FIKTMCLSX19   |         |
|   |   |   | left - Limited Edition                    | Quantum Grey  |  | R-FIKTMGRSX19   |         |
| left                                    | Blue  |  | R-FIKTMBLSX19                             |   |   |                 |         |
| <b>SX-F</b><br>vented airbox side panel | 250-450 Factory Edition   | 2018 > 2021   | left - OEM                                | White   |  | R-FIKTMBNSX99   | € 25,95 |
|   |   |   | left                                      | K Orange  |  | R-FIKTMARSX99   |         |
|   |   |   | left                                      | Grey 2021   |  | R-FIKTMGASX00   |         |
|   |   |   | left                                      | Black   |  | R-FIKTMNRSX99   |         |
|   |   |   | left                                      | Neon Yellow        |  | R-FIKTMGFSX99   |         |
|   |   |   | left                                      | Neon Orange        |  | R-FIKTMANSX99   |         |
|   |   |   | left                                      | Light Blue  |  | R-FIKTMCLSX99   |         |
|   |   |   | left - Limited Edition                    | Quantum Grey  |  | R-FIKTMGRSX99   |         |
| left                                    | Blue  |  | R-FIKTMBLSX99                             |   |   |                 |         |
| <b>SX-F</b><br>vented airbox side panel | 250-450 Factory Edition   | 2022  | left - OEM                                | White   |  | R-FIKTMBNSX23   | € 22,95 |
|   |   |   | left                                      | K Orange  |  | R-FIKTMARSX23   |         |
|   |   |   | left                                      | Black   |  | R-FIKTMNRSX23   |         |
|   |   |   | left                                      | Neptune Blue  |  | R-FIKTMNBSX23   |         |
|   |   |   | left                                      | Neon Orange        |  | R-FIKTMANSX23   |         |
|   |   |   | left                                      | Neon Yellow        |  | R-FIKTMGFSX23   |         |
|   |   |   | left                                      | Quantum Grey  |  | R-FIKTMGRSX23   |         |
|   |   |   | left - OEM                                | White   |  | R-FIKTMBNSX93   |         |
| left                                    | K Orange  |  | R-FIKTMARSX93                             |   |   |                 |         |
| left                                    | Black   |  | R-FIKTMNRSX93                             |   |   |                 |         |
| left                                    | Neptune Blue  |  | R-FIKTMNBSX93                             |   |   |                 |         |
| left                                    | Neon Orange  |  | R-FIKTMANSX93                             |   |   |                 |         |
| left                                    | Neon Yellow  |  | R-FIKTMGFSX93                             |   |   |                 |         |
| left                                    | Quantum Grey  |  | R-FIKTMGRSX93                             |   |   |                 |         |
| <b>EXC / EXCF</b>                       | 125 > 530   | 2008 > 2011   | OEM EXC 2008 > 2011 - right               | Black   |  | R-FIKTMNRDX07   | € 47,95 |
|   |   |   | right                                     | K Orange  |  | R-FIKTMARDX07   |         |
| <b>EXC / EXCF</b>                       | 125 > 530   | 2008 > 2011   | OEM EXC 2008-2011 - left                  | White   |  | R-FIKTMBNDX07   | € 31,95 |
|   |   |   | left                                      | Black   |  | R-FIKTMNRSX07   |         |
| <b>EXC / EXCF</b>                       | 125 > 500   | 2012-2013   | OEM - right                               | White   |  | R-FIKTMBNSX07   | € 23,95 |
|   |   |   | OEM Six Days - right                      | Black   |  | R-FIKTMARDX2T   |         |
| <b>EXC / EXCF</b>                       | 125-200-250-250F-300-350F-450-500   | 2012-2013   | OEM - left Bi-Color                       | K Orange-Black  |  | R-FIKTMARSX11   | € 27,95 |
|   |   |   | OEM Six Days - left                       | White-Black   |  | R-FIKTMBNSX11   |         |
| <b>EXC / EXCF</b>                       | 125-500   | 2014 > 2016   | OEM 2015-2016 Bi-Color - left             | Black   |  | R-FIKTMNRSX11   | € 27,95 |
|   |   |   | OEM 2014 Bi-Color - left                  | White-Neon Orange  |  | R-FIKTMBNARSX13 |         |
| <b>EXC / EXCF</b>                       | 125-500   | 2014 > 2016   | OEM - Six Days 2014-2015 - left           | K Orange-Black  |  | R-FIKTMARSX13   | € 27,95 |
|   |   |   | left                                      | White-Black   |  | R-FIKTMBNSX13   |         |
| <b>EXC / EXCF</b>                       | 125 > 500   | 2014 > 2016   | OEM 2015-2016 Bi-Color - right            | Black   |  | R-FIKTMNRSX13   | € 27,95 |
|   |   |   | OEM Bi-Color 2013-2014 - right            | White-Neon Orange  |  | R-FIKTMBNANSX13 |         |
| <b>EXC / EXCF</b>                       | 125 > 500   | 2014 > 2016   | OEM - Six Days 2014-2016 Bi-Color - right | K Orange-Black  |  | R-FIKTMARDX14   | € 27,95 |
|   |   |   | right                                     | White-Black   |  | R-FIKTMBNDX14   |         |
| <b>EXC / EXCF</b>                       | 125 > 500   | 2014 > 2016   | OEM Six Days 2014-2016 Bi-Color - right   | Black   |  | R-FIKTMNRDX14   | € 27,95 |
|   |   |   | right                                     | White-Neon Orange  |  | R-FIKTMBNANDX14 |         |

# KTM AIR BOX COVER / COPERCHIO LATERALE CASSA FILTRO

OEM original color -  fluorescent color

| MODEL  | CC                  | YEAR        | NOTES                                    | COLOR   | CODE          | PRICE   |
|--|---------------------|-------------|--|---|---------------|---------|
| <b>EXC / EXC-F<br/>XC-W</b>                                    | 250 > 500           | 2017 > 2019 | OEM 2019 - left                          | K Orange  | R-FIKTMARSX16 | € 25,95 |
|  |                     |             | OEM 2018 - left                          | White   | R-FIKTMBNSX16 |         |
|  |                     |             | left                                     | Black   | R-FIKTMNRSX16 |         |
|  |                     |             | left                                     | Neon Yellow    | R-FIKTMGFSX16 |         |
|  |                     |             | left                                     | Neon Orange    | R-FIKTMANSX16 |         |
|  |                     |             | left                                     | Green   | R-FIKTMVESX16 |         |
|  |                     |             | left                                     | Light Blue  | R-FIKTMCLSX16 |         |
|  |                     |             | left - Limited Edition                   | Quantum Grey  | R-FIKTMGRSX16 |         |
| <b>XC-W</b>  | 125-150             | 2017-2018   | OEM 2019 - left                          | K Orange  | R-FIKTMARSX16 | € 25,95 |
|  |                     |             | OEM 2018 - left                          | White   | R-FIKTMBNSX16 |         |
|  |                     |             | left                                     | Black   | R-FIKTMNRSX16 |         |
|  |                     |             | left                                     | Neon Yellow    | R-FIKTMGFSX16 |         |
|  |                     |             | left                                     | Neon Orange    | R-FIKTMANSX16 |         |
|  |                     |             | left                                     | Green   | R-FIKTMVESX16 |         |
|  |                     |             | left                                     | Light Blue  | R-FIKTMCLSX16 |         |
|  |                     |             | left - Limited Edition                   | Quantum Grey  | R-FIKTMGRSX16 |         |
| <b>EXC / EXC-F<br/>XC-W/XCF-W</b>                              | 125 > 500           | 2020 > 2023 | OEM Six Days / Erzberg Rodeo 2020 - left | White   | R-FIKTMBNSX19 | € 25,95 |
|  |                     |             | OEM 2020 and 2022-2023 - left            | K Orange  | R-FIKTMARSX19 |         |
|  |                     |             | OEM 2021 - left                          | Grey 2021   | R-FIKTMGASX21 |         |
|  |                     |             | left                                     | Black   | R-FIKTMNRSX19 |         |
|  |                     |             | left                                     | Neon Yellow    | R-FIKTMGFSX19 |         |
|  |                     |             | left                                     | Neon Orange    | R-FIKTMANSX19 |         |
|  |                     |             | left                                     | Light Blue  | R-FIKTMCLSX19 |         |
|  |                     |             | left - Limited Edition                   | Quantum Grey  | R-FIKTMGRSX19 |         |
| <b>EXC / EXC-F<br/>XC-W/XCF-W<br/>vented airbox side panel</b> | 150 > 500           | 2020 > 2023 | left - OEM Six Days / Erzberg Rodeo 2020 | White   | R-FIKTMBNSX99 | € 25,95 |
|  |                     |             | left - OEM 2020                          | K Orange  | R-FIKTMARSX99 |         |
|  |                     |             | left - OEM 2021                          | Grey 2021   | R-FIKTMGASX00 |         |
|  |                     |             | left                                     | Black   | R-FIKTMNRSX99 |         |
|  |                     |             | left                                     | Neon Yellow  | R-FIKTMGFSX99 |         |
|  |                     |             | left                                     | Neon Orange  | R-FIKTMANSX99 |         |
|  |                     |             | left                                     | Light Blue  | R-FIKTMCLSX99 |         |
|  |                     |             | left - Limited Edition                   | Quantum Grey  | R-FIKTMGRSX99 |         |
| <b>XC / XC-F</b>   | 250 > 450           | 2017-2018   | OEM - left                               | White   | R-FIKTMBNSX16 | € 25,95 |
|  |                     |             | left                                     | K Orange  | R-FIKTMARSX16 |         |
|  |                     |             | left                                     | Black   | R-FIKTMNRSX16 |         |
|  |                     |             | left                                     | Neon Yellow  | R-FIKTMGFSX16 |         |
|  |                     |             | left                                     | Neon Orange  | R-FIKTMANSX16 |         |
|  |                     |             | left                                     | Green   | R-FIKTMVESX16 |         |
|  |                     |             | left                                     | Light Blue  | R-FIKTMCLSX16 |         |
|  |                     |             | left - Limited Edition                   | Quantum Grey  | R-FIKTMGRSX16 |         |
| <b>XC / XC-F</b>   | 250-300-350-450     | 2019 > 2022 | OEM / Six Days / Erzberg Rodeo 2020      | White   | R-FIKTMBNSX19 | € 25,95 |
|  |                     |             | left                                     | K Orange  | R-FIKTMARSX19 |         |
|  |                     |             | left                                     | Grey 2021   | R-FIKTMGASX21 |         |
|  |                     |             | left                                     | Black   | R-FIKTMNRSX19 |         |
|  |                     |             | left                                     | Neon Yellow  | R-FIKTMGFSX19 |         |
|  |                     |             | left                                     | Neon Orange  | R-FIKTMANSX19 |         |
|  |                     |             | left                                     | Light Blue  | R-FIKTMCLSX19 |         |
|  |                     |             | left                                     | Quantum Grey  | R-FIKTMGRSX19 |         |
| <b>XC / XC-F<br/>vented airbox side panel</b>                  | 250-300-350-450     | 2019 > 2022 | left - OEM Six Days / Erzberg Rodeo 2020 | White   | R-FIKTMBNSX99 | € 25,95 |
|  |                     |             | left                                     | K Orange  | R-FIKTMARSX99 |         |
|  |                     |             | left                                     | Grey 2021   | R-FIKTMGASX00 |         |
|  |                     |             | left                                     | Black   | R-FIKTMNRSX99 |         |
|  |                     |             | left                                     | Neon Yellow  | R-FIKTMGFSX99 |         |
|  |                     |             | left                                     | Neon Orange  | R-FIKTMANSX99 |         |
|  |                     |             | left                                     | Light Blue  | R-FIKTMCLSX99 |         |
|  |                     |             | left - Limited Edition                   | Quantum Grey  | R-FIKTMGRSX99 |         |
| <b>XC / XC-F</b>   | 125-250-300-350-450 | 2023        | left - OEM                               | White   | R-FIKTMBNSX23 | € 22,95 |
|  |                     |             | left                                     | K Orange  | R-FIKTMARSX23 |         |
|  |                     |             | left                                     | Black   | R-FIKTMNRSX23 |         |
|  |                     |             | left                                     | Neptune Blue  | R-FIKTMNBSX23 |         |
|  |                     |             | left                                     | Neon Orange  | R-FIKTMANSX23 |         |
|  |                     |             | left                                     | Neon Yellow  | R-FIKTMGFSX23 |         |
|  |                     |             | left                                     | Quantum Grey  | R-FIKTMGRSX23 |         |
|  |                     |             | left - OEM                               | White   | R-FIKTMBNSX93 |         |
| <b>XC / XC-F<br/>vented airbox side panel</b>                  | 125-250-300-350-450 | 2023        | left - OEM                               | K Orange  | R-FIKTMARSX93 | € 22,95 |
|  |                     |             | left                                     | Black   | R-FIKTMNRSX93 |         |
|  |                     |             | left                                     | Neptune Blue  | R-FIKTMNBSX93 |         |
|  |                     |             | left                                     | Neon Orange  | R-FIKTMANSX93 |         |
|  |                     |             | left                                     | Neon Yellow  | R-FIKTMGFSX93 |         |
|  |                     |             | left                                     | Quantum Grey  | R-FIKTMGRSX93 |         |

**NEW**

**NEW**

# KTM AIR BOX COVER / COPERCHIO LATERALE CASSA FILTRO

## AVAILABLE COLORS

- Black
- Neutral



Pack Of 5 pcs  
R-BOCKTMNR516

| MODEL       | CC                          | YEAR        | NOTES  | COLOR   | CODE                                   | PRICE  |
|-------------|-----------------------------|-------------|--|---------|--|--------|
| SX          | 85                          | 2018 > 2023 | for side panels and airbox<br>for side panels and airbox | Black   | <input type="checkbox"/> R-BOCKTMNR516 | € 9,95 |
|             |                             |             |  | Neutral | <input type="checkbox"/> R-BOCKTMNT516 |        |
| SX/SXF/XC-F | 125-150-250-300-<br>350-450 | 2016 > 2023 | for side panels and airbox<br>for side panels and airbox | Black   | <input type="checkbox"/> R-BOCKTMNR516 | € 9,95 |
|             |                             |             |  | Neutral | <input type="checkbox"/> R-BOCKTMNT516 |        |
| EXC/EXC-F   | 250 > 500                   | 2017 > 2023 | for side panels and airbox<br>for side panels and airbox | Black   | <input type="checkbox"/> R-BOCKTMNR516 | € 9,95 |
| XC-W/XCF-W  |                             |             |  | Neutral | <input type="checkbox"/> R-BOCKTMNT516 |        |





**OVERSIZE REINFORCED  
RINFORZATE MAGGIORATE**

perimeter frame box  
made by technopolymer

Cornice perimetrale  
scatolata in tecnopolimero

## AVAILABLE COLORS

- K Orange
- Black
- White
- Neon Orange
- Neon Yellow

Horizontal bottom radiator protection.  
Prevents the collision between pipe and  
radiator on 250/300 2st.

Protezione orizzontale vaschetta radiatore  
Previene il contatto tra il radiatore e la marmitta  
nei modelli 250/300 2 tempi



**R-GRKTMAR0019**

Removable radiator louvers  
to clean the radiators without  
using tools.

Griglia removibile senza uso di  
attrezzi per pulizia radiatori

## OEM original color - ☀️ fluorescent color

| MODEL                   | CC                  | YEAR        | NOTES                   | COLOR       |    | CODE          | PRICE   |
|-------------------------|---------------------|-------------|-------------------------|-------------|----|---------------|---------|
| SX                      | 125-150             | 2016 > 2018 | OEM - Original radiator | Black       | ☀️ | R-GRKTMNR0017 | € 41,95 |
|                         |                     |             | Original radiator       | Neon Orange | ☀️ | R-GRKTMAN0017 |         |
|                         |                     |             | Original radiator       | K Orange    | ☀️ | R-GRKTMAR0017 |         |
|                         |                     |             | Original radiator       | White       | ☀️ | R-GRKTMBN0017 |         |
|                         |                     |             | Original radiator       | Neon Yellow | ☀️ | R-GRKTMGF0017 |         |
| SX                      | 250                 | 2017-2018   | OEM - Original radiator | Black       | ☀️ | R-GRKTMNR0017 | € 41,95 |
|                         |                     |             | Original radiator       | Neon Orange | ☀️ | R-GRKTMAN0017 |         |
|                         |                     |             | Original radiator       | K Orange    | ☀️ | R-GRKTMAR0017 |         |
|                         |                     |             | Original radiator       | White       | ☀️ | R-GRKTMBN0017 |         |
|                         |                     |             | Original radiator       | Neon Yellow | ☀️ | R-GRKTMGF0017 |         |
| SXF                     | 250-350-450         | 2016 > 2018 | OEM - Original radiator | Black       | ☀️ | R-GRKTMNR0017 | € 41,95 |
|                         |                     |             | Original radiator       | Neon Orange | ☀️ | R-GRKTMAN0017 |         |
|                         |                     |             | Original radiator       | K Orange    | ☀️ | R-GRKTMAR0017 |         |
|                         |                     |             | Original radiator       | White       | ☀️ | R-GRKTMBN0017 |         |
|                         |                     |             | Original radiator       | Neon Yellow | ☀️ | R-GRKTMGF0017 |         |
| EXC/EXCF<br>XC-W/XCF-W  | 125 > 500           | 2017 > 2019 | OEM - Original radiator | Black       | ☀️ | R-GRKTMNR0017 | € 41,95 |
|                         |                     |             | Original radiator       | Neon Orange | ☀️ | R-GRKTMAN0017 |         |
|                         |                     |             | Original radiator       | K Orange    | ☀️ | R-GRKTMAR0017 |         |
|                         |                     |             | Original radiator       | White       | ☀️ | R-GRKTMBN0017 |         |
|                         |                     |             | Original radiator       | Neon Yellow | ☀️ | R-GRKTMGF0017 |         |
| XC / XC-F               | 250-300-350-450     | 2017-2018   | OEM - Original radiator | Black       | ☀️ | R-GRKTMNR0017 | € 41,95 |
|                         |                     |             | Original radiator       | Neon Orange | ☀️ | R-GRKTMAN0017 |         |
|                         |                     |             | Original radiator       | K Orange    | ☀️ | R-GRKTMAR0017 |         |
|                         |                     |             | Original radiator       | White       | ☀️ | R-GRKTMBN0017 |         |
|                         |                     |             | Original radiator       | Neon Yellow | ☀️ | R-GRKTMGF0017 |         |
| XC/ XC-F                | 250-300-350-450     | 2019 > 2023 | OEM - Original radiator | Black       | ☀️ | R-GRKTMNR0019 | € 43,95 |
|                         |                     |             | Original radiator       | Neon Orange | ☀️ | R-GRKTMAN0019 |         |
|                         |                     |             | Original radiator       | K Orange    | ☀️ | R-GRKTMAR0019 |         |
|                         |                     |             | Original radiator       | White       | ☀️ | R-GRKTMBN0019 |         |
|                         |                     |             | Original radiator       | Neon Yellow | ☀️ | R-GRKTMGF0019 |         |
| SXF                     | 450 Factory Edition | 2018 > 2022 | OEM - Original radiator | Black       | ☀️ | R-GRKTMNR0019 | € 43,95 |
|                         |                     |             | Original radiator       | Neon Orange | ☀️ | R-GRKTMAN0019 |         |
|                         |                     |             | Original radiator       | K Orange    | ☀️ | R-GRKTMAR0019 |         |
|                         |                     |             | Original radiator       | White       | ☀️ | R-GRKTMBN0019 |         |
|                         |                     |             | Original radiator       | Neon Yellow | ☀️ | R-GRKTMGF0019 |         |
| SX/SXF                  | 125 > 450           | 2019 > 2023 | OEM - Original radiator | Black       | ☀️ | R-GRKTMNR0019 | € 43,95 |
|                         |                     |             | Original radiator       | Neon Orange | ☀️ | R-GRKTMAN0019 |         |
|                         |                     |             | Original radiator       | K Orange    | ☀️ | R-GRKTMAR0019 |         |
|                         |                     |             | Original radiator       | White       | ☀️ | R-GRKTMBN0019 |         |
|                         |                     |             | Original radiator       | Neon Yellow | ☀️ | R-GRKTMGF0019 |         |
| EXC/EXC-F<br>XC-W/XCF-W | 150 > 500           | 2020 > 2023 | OEM - Original radiator | Black       | ☀️ | R-GRKTMNR0019 | € 43,95 |
|                         |                     |             | Original radiator       | Neon Orange | ☀️ | R-GRKTMAN0019 |         |
|                         |                     |             | Original radiator       | K Orange    | ☀️ | R-GRKTMAR0019 |         |
|                         |                     |             | Original radiator       | White       | ☀️ | R-GRKTMBN0019 |         |
|                         |                     |             | Original radiator       | Neon Yellow | ☀️ | R-GRKTMGF0019 |         |



the additional reinforcing ribs and the extra perimetral hexagons on the back side grant an increased resistance in case of fall or hits

*Rinforzo perimetrale scatolato, preserva i radiatori in caso di impatto.*

**OVERSIZE REINFORCED  
RINFORZATE MAGGIORATE**



R-GRKTMNR0017

total protection of the top and bottom part of the stock radiator, it fully covers the part that with the standard louver remains without a shield against ground and stones. It also avoid the contact with the shroud on the top to avoid the damaging of the aluminum by the plastic.

*Maggiore copertura superiore ed inferiore a protezione della vaschetta radiatore. Evitano il contatto del convogliatore con la vaschetta nella zona superiore, ed il relativo danneggiamento.*

**KTM REPLACEMENT INNER RADIATOR LOUVERS (2 PCS)  
RICAMBIO INTERNO GRIGLIE RADIATORE (2 PZ)**

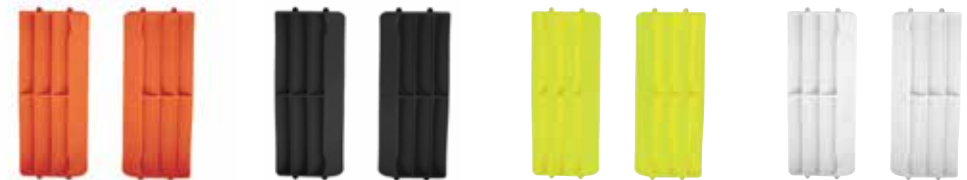

R-REPGRKTMAR9

R-REPGRKTMNR9

R-REPGRKTMGF9

R-REPGRKTMNB9

**AVAILABLE COLORS**

- K Orange
- Black
- White
- Neon Orange
- Neon Yellow

**OEM** original color - fluorescent color

| MODEL                   | CC                  | YEAR        | NOTES | COLOR       | CODE          | PRICE   |
|-------------------------|---------------------|-------------|-------|-------------|---------------|---------|
| XC/ XC-F                | 250-300-350-450     | 2019 > 2023 | OEM   | Black       | R-REPGRKTMNR9 | € 23,95 |
|                         |                     |             |       | Neon Orange | R-REPGRKTMAN9 |         |
|                         |                     |             |       | K Orange    | R-REPGRKTMAR9 |         |
|                         |                     |             |       | White       | R-REPGRKTMNB9 |         |
|                         |                     |             |       | Neon Yellow | R-REPGRKTMGF9 |         |
| SXF                     | 450 Factory Edition | 2018 > 2022 | OEM   | Black       | R-REPGRKTMNR9 | € 23,95 |
|                         |                     |             |       | Neon Orange | R-REPGRKTMAN9 |         |
|                         |                     |             |       | K Orange    | R-REPGRKTMAR9 |         |
|                         |                     |             |       | White       | R-REPGRKTMNB9 |         |
|                         |                     |             |       | Neon Yellow | R-REPGRKTMGF9 |         |
| SX/SXF                  | 125 > 450           | 2019 > 2023 | OEM   | Black       | R-REPGRKTMNR9 | € 23,95 |
|                         |                     |             |       | Neon Orange | R-REPGRKTMAN9 |         |
|                         |                     |             |       | K Orange    | R-REPGRKTMAR9 |         |
|                         |                     |             |       | White       | R-REPGRKTMNB9 |         |
|                         |                     |             |       | Neon Yellow | R-REPGRKTMGF9 |         |
| EXC/EXC-F<br>XC-W/XCF-W | 150 > 500           | 2020 > 2023 | OEM   | Black       | R-REPGRKTMNR9 | € 23,95 |
|                         |                     |             |       | Neon Orange | R-REPGRKTMAN9 |         |
|                         |                     |             |       | K Orange    | R-REPGRKTMAR9 |         |
|                         |                     |             |       | White       | R-REPGRKTMNB9 |         |
|                         |                     |             |       | Neon Yellow | R-REPGRKTMGF9 |         |

# KTM FRONT HEADLIGHT / MASCHERINA PORTAFARO



R-MASKKTMAR20



R-MASKKTMBN20



R-MASKKTMGR20



R-MASKKTMNR20



R-MASKKTMAN20

NEON



R-MASKKTMCL17



R-MASKKTMRQ17



R-MASKKTMGF17

NEON



R-MASKKTMNR17

## AVAILABLE COLORS

- K Orange
- White
- Black
- Neon Orange
- Light Blue
- Red
- Quantum Grey
- Neon Yellow

**OEM** original color - fluorescent color

| MODEL                  | CC        | YEAR        | NOTES  | COLOR        | CODE          | PRICE   |
|------------------------|-----------|-------------|--|--------------|---------------|---------|
| EXC/EXCF<br>XC-W/XCF-W | 125 > 500 | 2017 > 2019 | OEM 2017-2018 and Six Days 2019<br>OEM Six Days 2017<br><br>Limited Edition            | K Orange     | R-MASKKTMAR17 | € 29,95 |
|                        |           |             |  | White        | R-MASKKTMBN17 |         |
|                        |           |             |  | Neon Orange  | R-MASKKTMAN17 |         |
|                        |           |             |  | Light Blue   | R-MASKKTMCL17 |         |
|                        |           |             |  | Neon Yellow  | R-MASKKTMGF17 |         |
|                        |           |             |  | Black        | R-MASKKTMNR17 |         |
|                        |           |             |  | Quantum Grey | R-MASKKTMGR17 |         |
| EXC/EXCF<br>XC-W/XCF-W | 125 > 500 | 2020 > 2023 | OEM<br>OEM Six Days - Erzberg Rodeo 2020<br><br>Limited Edition<br><br>Limited Edition | K Orange     | R-MASKKTMAR20 | € 29,95 |
|                        |           |             |  | White        | R-MASKKTMBN20 |         |
|                        |           |             |  | Neon Orange  | R-MASKKTMAN20 |         |
|                        |           |             |  | Light Blue   | R-MASKKTMCL20 |         |
|                        |           |             |  | Neon Yellow  | R-MASKKTMGF20 |         |
|                        |           |             |  | Black        | R-MASKKTMNR20 |         |
|                        |           |             |  | Quantum Grey | R-MASKKTMGR20 |         |



| MODEL                  | CC        | YEAR        | NOTES                                       | COLOR | CODE          | PRICE   |
|------------------------|-----------|-------------|---|-------|---------------|---------|
| EXC/EXCF<br>XC-W/XCF-W | 125 > 530 | 2014 > 2023 | Replacement Mounting Elastic Bands<br>2 pcs | Black | R-ELASTNR0020 | € 10,95 |

# KTM FRONT NUMBER PLATE / TABELLA PORTANUMERO ANTERIORE



REPLICA

R-TBKTMAR0023



FACTORY EDITION

R-TBKTMAR0093

## AVAILABLE COLORS



OEM original color - ☀️ fluorescent color

| MODEL    | CC                                   | YEAR        | NOTES  | COLOR          | CODE          | PRICE   |
|----------|--------------------------------------|-------------|--|----------------|---------------|---------|
| SX       | 50                                   | 2016 > 2023 | OEM  | K Orange       | R-TBKTMAR0050 | € 25,95 |
|          |                                      |             |  | White          | R-TBKTMBN0050 |         |
|          |                                      |             |  | Black          | R-TBKTMNR0050 |         |
| SX-E     | 3 - 5                                | 2020 > 2023 | OEM 2023<br>OEM 2020 > 2022                            | K Orange       | R-TBKTMAR0050 | € 25,95 |
|          |                                      |             |  | White          | R-TBKTMBN0050 |         |
|          |                                      |             |  | Black          | R-TBKTMNR0050 |         |
| SX       | 65                                   | 2002 > 2008 | OEM  | K Orange       | R-TBKTMAR0065 | € 25,95 |
|          |                                      |             |  | White          | R-TBKTMBN0065 |         |
|          |                                      |             |  | Black          | R-TBKTMNR0065 |         |
| SX       | 65                                   | 2009 > 2015 | OEM 2011 > 2015<br>OEM 2009-2010                       | K Orange       | R-TBKTMAR0965 | € 27,95 |
|          |                                      |             |  | White          | R-TBKTMBN0965 |         |
|          |                                      |             |  | Black          | R-TBKTMNR0965 |         |
| SX       | 65                                   | 2016 > 2023 | OEM  | K Orange       | R-TBKTMAR1665 | € 25,95 |
|          |                                      |             |  | White          | R-TBKTMBN1665 |         |
|          |                                      |             |  | Black          | R-TBKTMNR1665 |         |
| SX       | 85                                   | 2004 > 2012 | OEM 2011-2012<br>OEM 2003 > 2010                       | K Orange       | R-TBKTMAR0085 | € 25,95 |
|          |                                      |             |  | White          | R-TBKTMBN0085 |         |
|          |                                      |             |  | Black          | R-TBKTMNR0085 |         |
| SX       | 85                                   | 2013 > 2017 | OEM  | K Orange       | R-TBKTMAR0985 | € 27,95 |
|          |                                      |             |  | White          | R-TBKTMBN0985 |         |
|          |                                      |             |  | Black          | R-TBKTMNR0985 |         |
| SX       | 85                                   | 2018 > 2023 | OEM  | White          | R-TBKTMBN0185 | € 27,95 |
|          |                                      |             |  | K Orange       | R-TBKTMAR0185 |         |
|          |                                      |             |  | Black          | R-TBKTMNR0185 |         |
| SX / SXF | 125-250F-400-450-525                 | 2003 > 2006 | OEM  | Neon Orange ☀️ | R-TBKTMAN0185 | € 27,95 |
|          |                                      |             |  | Neon Yellow ☀️ | R-TBKTMGF0185 |         |
|          |                                      |             |  | K Orange       | R-TBKTMAR0300 |         |
| SX / SXF | 125-144-150-250-250F<br>350F-450-505 | 2007 > 2012 | OEM - Bi-Color 2011-2012<br>OEM - Bi-Color 2007 > 2010 | White          | R-TBKTMBN0300 | € 27,95 |
|          |                                      |             |  | Black          | R-TBKTMNR0300 |         |
|          |                                      |             |  | K Orange       | R-TBKTMAR0007 |         |
| SX / SXF | 125-144-150-250-250F<br>350F-450-505 | 2007 > 2012 | OEM - Bi-Color 2011-2012<br>OEM - Bi-Color 2007 > 2010 | White          | R-TBKTMBN0007 | € 30,95 |
|          |                                      |             |  | Black          | R-TBKTMNR0007 |         |
|          |                                      |             |  | K Orange       | R-TBKTMAR0007 |         |
| SX       | 125-150                              | 2013 > 2015 | OEM  | K Orange       | R-TBKTMAR0013 | € 28,95 |
|          |                                      |             |  | White          | R-TBKTMBN0013 |         |
|          |                                      |             |  | Black          | R-TBKTMNR0013 |         |
| SX       | 125-150                              | 2016 > 2018 | OEM  | White          | R-TBKTMBN0016 | € 29,95 |
|          |                                      |             |  | K Orange       | R-TBKTMAR0016 |         |
|          |                                      |             |  | Black          | R-TBKTMNR0016 |         |
| SX       | 125-150-250                          | 2019 > 2022 | Limited Edition  | Neon Yellow ☀️ | R-TBKTMGF0016 | € 29,95 |
|          |                                      |             |  | Neon Orange ☀️ | R-TBKTMAN0016 |         |
|          |                                      |             |  | Quantum Grey   | R-TBKTMGR0016 |         |
| SX       | 125-150-250                          | 2019 > 2022 | OEM  | K Orange       | R-TBKTMAR0019 | € 29,95 |
|          |                                      |             |  | Black          | R-TBKTMNR0019 |         |
|          |                                      |             |  | White          | R-TBKTMBN0019 |         |
| SX       | 125-150-250                          | 2019 > 2022 | OEM  | Neon Yellow ☀️ | R-TBKTMGF0019 | € 29,95 |
|          |                                      |             |  | Neon Orange ☀️ | R-TBKTMAN0019 |         |
|          |                                      |             |  | Quantum Grey   | R-TBKTMGR0019 |         |
| SX       | 125-250-300                          | 2023        | OEM  | K Orange       | R-TBKTMAR0023 | € 22,95 |
|          |                                      |             |  | White          | R-TBKTMBN0023 |         |
|          |                                      |             |  | Black          | R-TBKTMNR0023 |         |
| SX       | 125-250-300                          | 2023        | OEM  | Neptun Blue ☀️ | R-TBKTMNB0023 | € 22,95 |
|          |                                      |             |  | Neon Orange ☀️ | R-TBKTMAN0023 |         |
|          |                                      |             |  | Neon Yellow ☀️ | R-TBKTMGF0023 |         |
| SX       | 125-250-300                          | 2023        | OEM  | Quantum Grey   | R-TBKTMGR0023 | € 22,95 |
|          |                                      |             |  | K Orange       | R-TBKTMAR0013 |         |
|          |                                      |             |  | White          | R-TBKTMBN0013 |         |
| SX       | 250                                  | 2013 > 2016 | OEM  | Black          | R-TBKTMNR0013 | € 28,95 |
|          |                                      |             |  | White          | R-TBKTMBN0013 |         |
|          |                                      |             |  | K Orange       | R-TBKTMAR0013 |         |

NEW

# KTM FRONT NUMBER PLATE / TABELLA PORTANUMERO ANTERIORE

## AVAILABLE COLORS



**OEM** original color - fluorescent color

| MODEL            | CC                      | YEAR        | NOTES | COLOR        | CODE |               |         |
|------------------|-------------------------|-------------|-------|--------------|------|---------------|---------|
| <b>SX</b>        | 250                     | 2017-2018   | OEM   | White        |      | R-TBKTMBN0016 | € 29,95 |
|                  |                         |             |       | K Orange     |      | R-TBKTMAR0016 |         |
|                  |                         |             |       | Black        |      | R-TBKTMNR0016 |         |
|                  |                         |             |       | Neon Yellow  |      | R-TBKTMGF0016 |         |
|                  |                         |             |       | Neon Orange  |      | R-TBKTMAN0016 |         |
|                  |                         |             |       | Quantum Grey |      | R-TBKTMGR0016 |         |
| <b>SXF</b>       | 250-350-450             | 2013 > 2015 | OEM   | K Orange     |      | R-TBKTMAR0013 | € 28,95 |
|                  |                         |             |       | White        |      | R-TBKTMBN0013 |         |
|                  |                         |             |       | Black        |      | R-TBKTMNR0013 |         |
|                  |                         |             |       | White        |      | R-TBKTMBN0016 |         |
|                  |                         |             |       | K Orange     |      | R-TBKTMAR0016 |         |
|                  |                         |             |       | Black        |      | R-TBKTMNR0016 |         |
| <b>SXF</b>       | 250-350-450             | 2016 > 2018 | OEM   | White        |      | R-TBKTMBN0016 | € 29,95 |
|                  |                         |             |       | K Orange     |      | R-TBKTMAR0016 |         |
|                  |                         |             |       | Black        |      | R-TBKTMNR0016 |         |
|                  |                         |             |       | Neon Yellow  |      | R-TBKTMGF0016 |         |
|                  |                         |             |       | Neon Orange  |      | R-TBKTMAN0016 |         |
|                  |                         |             |       | Quantum Grey |      | R-TBKTMGR0016 |         |
| <b>SXF</b>       | 250-350-450             | 2019 > 2022 | OEM   | K Orange     |      | R-TBKTMAR0019 | € 29,95 |
|                  |                         |             |       | Black        |      | R-TBKTMNR0019 |         |
|                  |                         |             |       | White        |      | R-TBKTMBN0019 |         |
|                  |                         |             |       | Neon Yellow  |      | R-TBKTMGF0019 |         |
|                  |                         |             |       | Neon Orange  |      | R-TBKTMAN0019 |         |
|                  |                         |             |       | Quantum Grey |      | R-TBKTMGR0019 |         |
| <b>SXF</b>       | 250-350-450             | 2023        | OEM   | K Orange     |      | R-TBKTMAR0023 | € 22,95 |
|                  |                         |             |       | White        |      | R-TBKTMBN0023 |         |
|                  |                         |             |       | Black        |      | R-TBKTMNR0023 |         |
|                  |                         |             |       | Neptun Blue  |      | R-TBKTMNB0023 |         |
|                  |                         |             |       | Neon Orange  |      | R-TBKTMAN0023 |         |
|                  |                         |             |       | Neon Yellow  |      | R-TBKTMGF0023 |         |
| <b>SXF</b>       | 450 Factory Edition     | 2018 > 2021 | OEM   | K Orange     |      | R-TBKTMAR0019 | € 29,95 |
|                  |                         |             |       | Black        |      | R-TBKTMNR0019 |         |
|                  |                         |             |       | White        |      | R-TBKTMBN0019 |         |
|                  |                         |             |       | Neon Yellow  |      | R-TBKTMGF0019 |         |
|                  |                         |             |       | Neon Orange  |      | R-TBKTMAN0019 |         |
|                  |                         |             |       | Quantum Grey |      | R-TBKTMGR0019 |         |
| <b>SXF</b>       | 250-450 Factory Edition | 2022        | OEM   | K Orange     |      | R-TBKTMAR0023 | € 22,95 |
|                  |                         |             |       | White        |      | R-TBKTMBN0023 |         |
|                  |                         |             |       | Black        |      | R-TBKTMNR0023 |         |
|                  |                         |             |       | Neptun Blue  |      | R-TBKTMNB0023 |         |
|                  |                         |             |       | Neon Orange  |      | R-TBKTMAN0023 |         |
|                  |                         |             |       | Neon Yellow  |      | R-TBKTMGF0023 |         |
| <b>XC / XC-F</b> | 250-300-350-450         | 2017-2018   | OEM   | White        |      | R-TBKTMBN0016 | € 29,95 |
|                  |                         |             |       | K Orange     |      | R-TBKTMAR0016 |         |
|                  |                         |             |       | Black        |      | R-TBKTMNR0016 |         |
|                  |                         |             |       | Neon Yellow  |      | R-TBKTMGF0016 |         |
|                  |                         |             |       | Neon Orange  |      | R-TBKTMAN0016 |         |
|                  |                         |             |       | Quantum Grey |      | R-TBKTMGR0016 |         |
| <b>XC / XC-F</b> | 250-300-350-450         | 2019 > 2022 | OEM   | White        |      | R-TBKTMBN0019 | € 29,95 |
|                  |                         |             |       | K Orange     |      | R-TBKTMAR0019 |         |
|                  |                         |             |       | Black        |      | R-TBKTMNR0019 |         |
|                  |                         |             |       | Neon Yellow  |      | R-TBKTMGF0019 |         |
|                  |                         |             |       | Neon Orange  |      | R-TBKTMAN0019 |         |
|                  |                         |             |       | Quantum Grey |      | R-TBKTMGR0019 |         |
| <b>XC / XC-F</b> | 125-250-300-350-450     | 2023        | OEM   | K Orange     |      | R-TBKTMAR0023 | € 22,95 |
|                  |                         |             |       | White        |      | R-TBKTMBN0023 |         |
|                  |                         |             |       | Black        |      | R-TBKTMNR0023 |         |
|                  |                         |             |       | Neptun Blue  |      | R-TBKTMNB0023 |         |
|                  |                         |             |       | Neon Orange  |      | R-TBKTMAN0023 |         |
|                  |                         |             |       | Neon Yellow  |      | R-TBKTMGF0023 |         |

**NEW**

**NEW**

**NEON**



R-TBKTMAR0013



R-TBKTMGF0019



R-TBKTMBN0016

**FACTORY EDITION**

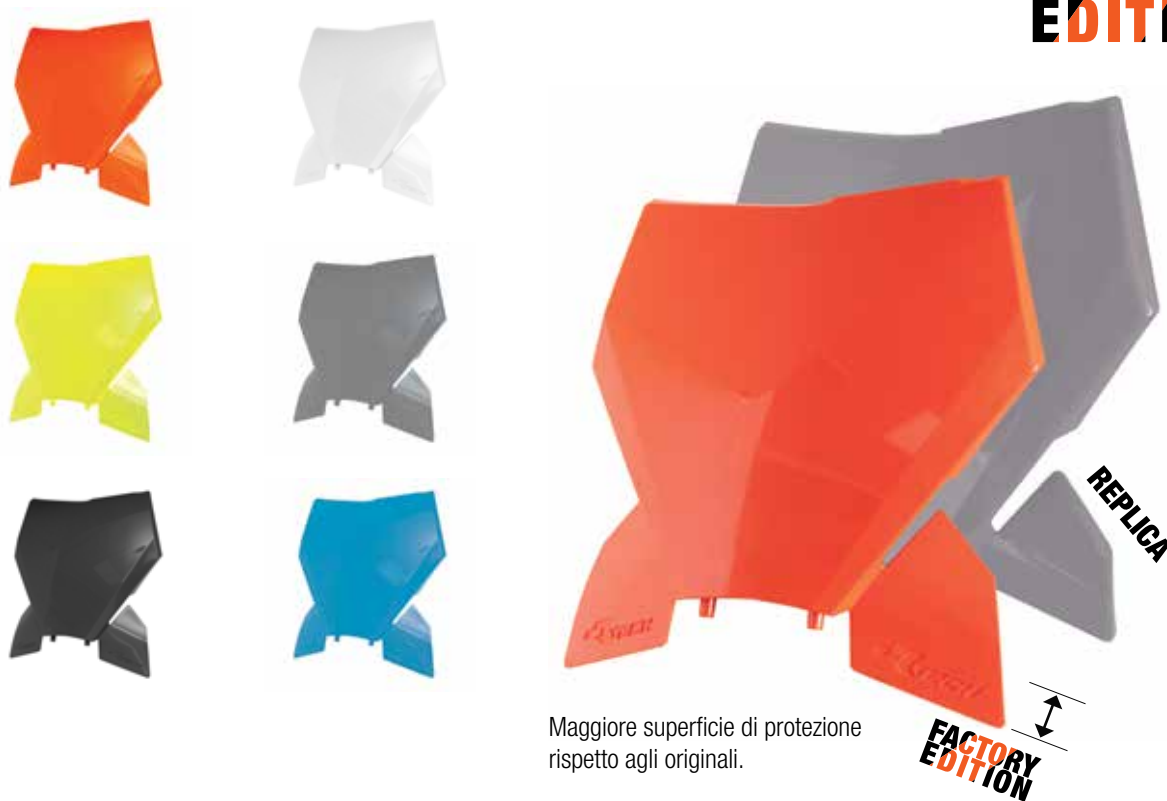

Maggiore superficie di protezione rispetto agli originali.

Enhanced protection surface for a better protection

**AVAILABLE COLORS**

- K Orange
- White
- Black
- Quantum Grey
- Neon Yellow
- Neon Orange

**OEM** original color - ☀️ fluorescent color

| MODEL     | CC                      | YEAR | NOTES | COLOR        | CODE          | PRICE   |
|-----------|-------------------------|------|-------|--------------|---------------|---------|
| SX        | 125-250-300             | 2023 | OEM   | K Orange     | R-TBKTMAR0093 | € 22,95 |
|           |                         |      |       | White        | R-TBKTMBN0093 |         |
|           |                         |      |       | Black        | R-TBKTMNR0093 |         |
|           |                         |      |       | Neptune Blue | R-TBKTMNB0093 |         |
|           |                         |      |       | Neon Orange  | R-TBKTMAN0093 |         |
|           |                         |      |       | Neon Yellow  | R-TBKTMGF0093 |         |
|           |                         |      |       | Quantum Grey | R-TBKTMGR0093 |         |
| SXF       | 250-350-450             | 2023 | OEM   | K Orange     | R-TBKTMAR0093 | € 22,95 |
|           |                         |      |       | White        | R-TBKTMBN0093 |         |
|           |                         |      |       | Black        | R-TBKTMNR0093 |         |
|           |                         |      |       | Neptune Blue | R-TBKTMNB0093 |         |
|           |                         |      |       | Neon Orange  | R-TBKTMAN0093 |         |
|           |                         |      |       | Neon Yellow  | R-TBKTMGF0093 |         |
|           |                         |      |       | Quantum Grey | R-TBKTMGR0093 |         |
| SXF       | 250-450 Factory Edition | 2022 | OEM   | K Orange     | R-TBKTMAR0093 | € 22,95 |
|           |                         |      |       | White        | R-TBKTMBN0093 |         |
|           |                         |      |       | Black        | R-TBKTMNR0093 |         |
|           |                         |      |       | Neptune Blue | R-TBKTMNB0093 |         |
|           |                         |      |       | Neon Orange  | R-TBKTMAN0093 |         |
|           |                         |      |       | Neon Yellow  | R-TBKTMGF0093 |         |
|           |                         |      |       | Quantum Grey | R-TBKTMGR0093 |         |
| XC / XC-F | 125-250-300-350-450     | 2023 | OEM   | K Orange     | R-TBKTMAR0093 | € 22,95 |
|           |                         |      |       | White        | R-TBKTMBN0093 |         |
|           |                         |      |       | Black        | R-TBKTMNR0093 |         |
|           |                         |      |       | Neptune Blue | R-TBKTMNB0093 |         |
|           |                         |      |       | Neon Orange  | R-TBKTMAN0093 |         |
|           |                         |      |       | Neon Yellow  | R-TBKTMGF0093 |         |
|           |                         |      |       | Quantum Grey | R-TBKTMGR0093 |         |

**NEW**

**FACTORY EDITION**

**NEW**

**FACTORY EDITION**

**NEW**

**FACTORY EDITION**

**NEW**

**FACTORY EDITION**





R-PSKTMCL0016



R-PSKTMGF0015



R-PSKTMAR0023



R-PSKTMAR0093

AVAILABLE COLORS

- K Orange
- White
- Black
- Light Blue
- Neon Orange
- Neon Yellow

OEM original color - fluorescent color

| MODEL          | CC   | YEAR        | NOTES   | COLOR        | CODE          | PRICE   |
|----------------|--|-------------|---|--------------|---------------|---------|
| SX             | 50   | 2016 > 2023 | OEM 2023<br>OEM 2016 > 2020<br>OEM 2021-2022  | K Orange     | R-PSKTMAR1965 | € 29,95 |
|                |  |             |   | White        | R-PSKTMBN1965 |         |
|                |  |             |   | Black        | R-PSKTMNR1965 |         |
| SX-E           | 3 - 5  | 2020 > 2023 | OEM 2023<br>OEM 2020 > 2022   | K Orange     | R-PSKTMAR1965 | € 29,95 |
|                |  |             |   | White        | R-PSKTMBN1965 |         |
|                |  |             |   | Black        | R-PSKTMNR1965 |         |
| SX             | 65   | 2019 > 2023 | OEM 2023 - adaptable from 2002<br>OEM 2019-2020 - adaptable from 2002<br>OEM 2021-2022 - adaptable from 2002      | K Orange     | R-PSKTMAR1965 | € 29,95 |
|                |  |             |   | White        | R-PSKTMBN1965 |         |
|                |  |             |   | Black        | R-PSKTMNR1965 |         |
| SX             | 85   | 2009 > 2017 | OEM 2011 > 17 - adaptable 2003 > 17<br>OEM 2003 > 06 - adaptable 2003 > 17<br>OEM 2007 > 10 - adaptable 2003 > 17 | K Orange     | R-PSKTMAR0985 | € 31,95 |
|                |  |             |   | White        | R-PSKTMBN0985 |         |
|                |  |             |   | Black        | R-PSKTMNR0985 |         |
| SX             | 85   | 2018 > 2023 | OEM   | White        | R-PSKTMBN0185 | € 31,95 |
|                |  |             |   | Black        | R-PSKTMNR0185 |         |
|                |  |             |   | K Orange     | R-PSKTMAR0185 |         |
|                |  |             |   | Neon Orange  | R-PSKTMAN0185 |         |
|                |  |             |   | Neon Yellow  | R-PSKTMGF0185 |         |
|                |  |             |   | Light Blue   | R-PSKTMCL0185 |         |
| SX / SXF / EXC | 125-144-150-200-250-250F-300-400-450-520-525 | 2000 > 2007 |   | K Orange     | R-PSKTMAR0000 | € 34,95 |
|                |  |             |   | White        | R-PSKTMBN0000 |         |
|                |  |             |   | Black        | R-PSKTMNR0000 |         |
| SX             | 125-144-150-250                              | 2008 > 2014 | OEM 2010 > 2014 - 2011 > 15<br>OEM - 2008-2009 - 2010<br>OEM 2008-2009  | K Orange     | R-PSKTMAR0008 | € 34,95 |
|                |  |             |   | White        | R-PSKTMBN0008 |         |
|                |  |             |   | Black        | R-PSKTMNR0008 |         |
| SXF            | 250-350-450-505                              | 2008 > 2014 | OEM 2010 > 2014 - 2011 > 15<br>OEM - 2008-2009 - 2010<br>OEM 2008-2009  | K Orange     | R-PSKTMAR0008 | € 34,95 |
|                |  |             |   | White        | R-PSKTMBN0008 |         |
|                |  |             |   | Black        | R-PSKTMNR0008 |         |
| SX             | 125-150-250                                  | 2015 > 2022 | OEM 2015-2016 and 2018 > 2020 and 2022<br>OEM 2017  | White        | R-PSKTMBN0020 | € 34,95 |
|                |  |             |   | K Orange     | R-PSKTMAR0016 |         |
|                |  |             |   | Neon Yellow  | R-PSKTMGF0015 |         |
|                |  |             |   | Neon Orange  | R-PSKTMAN0016 |         |
|                |  |             |   | Light Blue   | R-PSKTMCL0016 |         |
|                |  |             | OEM 2021  | Black        | R-PSKTMNR0015 |         |
|                |  |             |   | Quantum Grey | R-PSKTMGR0020 |         |
|                |  |             |   | Grey 2021    | R-PSKTMGA0022 |         |
| SX             | 125-250-300                                  | 2023        | OEM   | K Orange     | R-PSKTMAR0023 | € 29,95 |
|                |  |             |   | Black        | R-PSKTMNR0023 |         |
|                |  |             |   | White        | R-PSKTMBN0023 |         |
|                |  |             |   | Light Blue   | R-PSKTMNB0023 |         |
|                |  |             |   | Neon Orange  | R-PSKTMAN0023 |         |
|                |  |             |   | Neon Yellow  | R-PSKTMGF0023 |         |
|                |  |             |   | Quantum Grey | R-PSKTMGR0023 |         |
| SXF            | 250-350-450                                  | 2015 > 2022 | OEM 2017<br>OEM 2015-2016 and 2018 > 2020 and 2022  | K Orange     | R-PSKTMAR0016 | € 34,95 |
|                |  |             |   | White        | R-PSKTMBN0020 |         |
|                |  |             |   | Neon Yellow  | R-PSKTMGF0015 |         |
|                |  |             |   | Neon Orange  | R-PSKTMAN0016 |         |
|                |  |             |   | Light Blue   | R-PSKTMCL0016 |         |
|                |  |             |   | Black        | R-PSKTMNR0015 |         |
|                |  |             |   | Quantum Grey | R-PSKTMGR0020 |         |
|                |  |             |   | Grey 2021    | R-PSKTMGA0022 |         |
| SXF            | 250-350-450                                  | 2023        | OEM   | K Orange     | R-PSKTMAR0023 | € 29,95 |
|                |  |             |   | Black        | R-PSKTMNR0023 |         |
|                |  |             |   | White        | R-PSKTMBN0023 |         |
|                |  |             |   | Light Blue   | R-PSKTMNB0023 |         |
|                |  |             |   | Neon Orange  | R-PSKTMAN0023 |         |
|                |  |             |   | Neon Yellow  | R-PSKTMGF0023 |         |
|                |  |             |   | Quantum Grey | R-PSKTMGR0023 |         |
| SXF            | 450 Factory Edition                          | 2015 > 2021 | OEM   | K Orange     | R-PSKTMAR0016 | € 34,95 |
|                |  |             |   | White        | R-PSKTMBN0020 |         |
|                |  |             |   | Neon Yellow  | R-PSKTMGF0015 |         |
|                |  |             |   | Neon Orange  | R-PSKTMAN0016 |         |
|                |  |             |   | Light Blue   | R-PSKTMCL0016 |         |
|                |  |             | OEM 2021  | Black        | R-PSKTMNR0015 |         |
|                |  |             |   | Quantum Grey | R-PSKTMGR0020 |         |
|                |  |             |   | Grey 2021    | R-PSKTMGA0022 |         |

NEW

NEW

NEW

# KTM FORK PROTECTORS / PARASTELI FORCELLA

| MODEL                   | CC  | YEAR          | NOTES  | COLOR        |               | CODE          | PRICE         |         |
|-------------------------|---|---------------|--|--------------|---------------|---------------|---------------|---------|
| <b>SXF</b>              | 250-450 Factory Edition                   | 2022          | OEM  | K Orange     |               | R-PSKTMAR0023 | € 29,95       |         |
|                         |   |               |  | Black        |               | R-PSKTMNR0023 |               |         |
|                         |   |               |  | White        |               | R-PSKTMNB0023 |               |         |
|                         |   |               |  | Light Blue   |               | R-PSKTMNB0023 |               |         |
|                         |   |               |  | Neon Orange  | ☀             | R-PSKTMAN0023 |               |         |
|                         |   |               |  | Neon Yellow  | ☀             | R-PSKTMGF0023 |               |         |
|                         |   |               | Quantum Grey   |              | R-PSKTMGR0023 |               |               |         |
| <b>EXC / EXCF</b>       | 125-200-250-250F-300-350F-400-450-500-530 | 2008 > 2015   | OEM 2010 > 14 - 2011 > 15<br>OEM - 2008-2009, 2010<br>OEM - 2008-2009                                  | K Orange     |               | R-PSKTMAR0008 | € 34,95       |         |
|                         |   |               |  | White        |               | R-PSKTMNB0008 |               |         |
|                         |   |               |  | Black        |               | R-PSKTMNR0008 |               |         |
| <b>EXC / EXCF</b>       | 250 > 500                                 | 2016 > 2023   | OEM 18 > 21 - Six Days 19-20 - Erzberg Rodeo 20-21<br>OEM 2016<br>OEM 2017 - Six Days 2017-18 and 2021 | Black        |               | R-PSKTMNR0015 | € 34,95       |         |
|                         |   |               |  | White 2020   |               | R-PSKTMNB0020 |               |         |
|                         |   |               |  | K Orange     |               | R-PSKTMAR0016 |               |         |
|                         |   |               |  | Neon Yellow  | ☀             | R-PSKTMGF0015 |               |         |
|                         |   |               |  | Neon Orange  | ☀             | R-PSKTMAN0016 |               |         |
|                         |   |               |  | Light Blue   |               | R-PSKTMCL0016 |               |         |
|                         |   |               |  | Quantum Grey |               | R-PSKTMGR0020 |               |         |
|                         |   |               |  | Grey 2021    |               | R-PSKTMGA0022 |               |         |
| <b>XC-F / XC</b>        | 250-300-350-450                           | 2017 > 2022   | OEM 2018 > 2020  | White 2020   |               | R-PSKTMNB0020 | € 34,95       |         |
|                         |   |               |  | Neon Yellow  | ☀             | R-PSKTMGF0015 |               |         |
|                         |   |               |  | Neon Orange  | ☀             | R-PSKTMAN0016 |               |         |
|                         |   |               |  | K Orange     |               | R-PSKTMAR0016 |               |         |
|                         |   |               |  | Light Blue   |               | R-PSKTMCL0016 |               |         |
|                         |   | OEM 2017      | Black  |              | R-PSKTMNR0015 |               |               |         |
|                         |   |               | Quantum Grey   |              | R-PSKTMGR0020 |               |               |         |
|                         |   |               | Grey 2021  |              | R-PSKTMGA0022 |               |               |         |
|                         |   |               | K Orange   |              | R-PSKTMAR0023 | € 29,95       |               |         |
|                         |   |               | Black  |              | R-PSKTMNR0023 |               |               |         |
|                         |   |               | White  |              | R-PSKTMNB0023 |               |               |         |
| Light Blue              |   | R-PSKTMNB0023 |  |              |               |               |               |         |
| Neon Orange             | ☀   | R-PSKTMAN0023 |  |              |               |               |               |         |
| Neon Yellow             | ☀   | R-PSKTMGF0023 |  |              |               |               |               |         |
| <b>XC-W / XCF-W</b>     | 150-250-300-350-450-500                   | 2017 > 2023   | OEM 2018 > 2020  | White 2020   |               | R-PSKTMNB0020 | € 34,95       |         |
|                         |   |               |  | Neon Yellow  | ☀             | R-PSKTMGF0015 |               |         |
|                         |   |               |  | Neon Orange  | ☀             | R-PSKTMAN0016 |               |         |
|                         |   |               |  | K Orange     |               | R-PSKTMAR0016 |               |         |
|                         |   |               |  | Light Blue   |               | R-PSKTMCL0016 |               |         |
|                         |   | OEM 2017      | Black  |              | R-PSKTMNR0015 |               |               |         |
|                         |   |               | Quantum Grey   |              | R-PSKTMGR0020 |               |               |         |
|                         |   |               | Grey 2021  |              | R-PSKTMGA0022 |               |               |         |
|                         |   |               | K Orange   |              | R-PSKTMAR0000 | € 34,95       |               |         |
|                         |   |               | White  |              | R-PSKTMNB0000 |               |               |         |
|                         |   |               | Black  |              | R-PSKTMNR0000 |               |               |         |
| <b>LC4 / SMC / DUKE</b> | 620-640-660                               | 2003 > 2007   |  | K Orange     |               |               | R-PSKTMAR0000 | € 34,95 |
|                         |   |               |  | White        |               |               | R-PSKTMNB0000 |         |
|                         |   |               |  | Black        |               |               | R-PSKTMNR0000 |         |





Parasteli Factory avvolgenti, con una più ampia superficie di protezione rispetto agli originali.

*Enveloping factory fork protectors with an enhanced cover surface for a better protection.*

| MODEL     | CC                      | YEAR | NOTES | COLOR        | CODE          | PRICE   |
|-----------|-------------------------|------|-------|--------------|---------------|---------|
| SX        | 125-250-300             | 2023 | OEM   | K Orange     | R-PSKTMAR0093 | € 29,95 |
|           |                         |      |       | Black        | R-PSKTMNR0093 |         |
|           |                         |      |       | White        | R-PSKTMNB0093 |         |
|           |                         |      |       | Neptune Blue | R-PSKTMNB0093 |         |
|           |                         |      |       | Neon Orange  | R-PSKTMAN0093 |         |
|           |                         |      |       | Neon Yellow  | R-PSKTMGF0093 |         |
|           |                         |      |       | Quantum Grey | R-PSKTMGR0093 |         |
| SXF       | 250-350-450             | 2023 | OEM   | K Orange     | R-PSKTMAR0093 | € 29,95 |
|           |                         |      |       | Black        | R-PSKTMNR0093 |         |
|           |                         |      |       | White        | R-PSKTMNB0093 |         |
|           |                         |      |       | Neptune Blue | R-PSKTMNB0093 |         |
|           |                         |      |       | Neon Orange  | R-PSKTMAN0093 |         |
|           |                         |      |       | Neon Yellow  | R-PSKTMGF0093 |         |
|           |                         |      |       | Quantum Grey | R-PSKTMGR0093 |         |
| SXF       | 250-450 Factory Edition | 2022 | OEM   | K Orange     | R-PSKTMAR0093 | € 29,95 |
|           |                         |      |       | Black        | R-PSKTMNR0093 |         |
|           |                         |      |       | White        | R-PSKTMNB0093 |         |
|           |                         |      |       | Neptune Blue | R-PSKTMNB0093 |         |
|           |                         |      |       | Neon Orange  | R-PSKTMAN0093 |         |
|           |                         |      |       | Neon Yellow  | R-PSKTMGF0093 |         |
|           |                         |      |       | Quantum Grey | R-PSKTMGR0093 |         |
| XC / XC-F | 125-250-300-350-450     | 2023 | OEM   | K Orange     | R-PSKTMAR0093 | € 29,95 |
|           |                         |      |       | Black        | R-PSKTMNR0093 |         |
|           |                         |      |       | White        | R-PSKTMNB0093 |         |
|           |                         |      |       | Neptune Blue | R-PSKTMNB0093 |         |
|           |                         |      |       | Neon Orange  | R-PSKTMAN0093 |         |
|           |                         |      |       | Neon Yellow  | R-PSKTMGF0093 |         |
|           |                         |      |       | Quantum Grey | R-PSKTMGR0093 |         |



## KTM CHAIN GUIDE / CRUNA GUIDA CATENA



R-CRUKTMNRAR7



R-CRUKTMNRNT7



MONOBLOCK R2.0 WORX  
CHAIN GUIDE  
PAG. 254

### AVAILABLE COLORS

K Orange
  Black
  Black-K Orange
  Black-Neutral

**OEM** original color

| MODEL      | CC                              | YEAR        | NOTES                  | COLOR            | CODE           | PRICE   |
|------------|---------------------------------|-------------|------------------------|------------------|----------------|---------|
| SX-E       | 3 - 5                           | 2020 > 2023 | OEM                    | Black            | R-CRUKTMNR165  | € 25,95 |
| SX         | 50-65                           | 2016 > 2023 | OEM                    | K Orange         | R-CRUKTMAR165  | € 25,95 |
|            |                                 |             |                        | Black            | R-CRUKTMNR165  |         |
| SX         | 85                              | 2004 > 2014 | OEM                    | K Orange         | R-CRUKTMAR165  | € 25,95 |
|            |                                 |             |                        | Black            | R-CRUKTMNR000  |         |
| SX         | 85                              | 2015 > 2022 | OEM - Bi-Material      | K Orange         | R-CRUKTMAR000  | € 25,95 |
|            |                                 |             |                        | Black-Neutral    | R-CRUKTMNRNT14 |         |
| SX / SXF   | 125-200-250-400-450-520         | 1994 > 2006 | OEM                    | Black-K Orange   | R-CRUKTMNRAR14 | € 38,95 |
|            |                                 |             |                        | Black            | R-CRUKTMNR000  |         |
| SX         | 125-144-150-250                 | 2007        | OEM - Bi-Material      | Black            | R-CRUKTMAR000  | € 38,95 |
|            |                                 |             |                        | Black-Neutral    | R-CRUKTMNRNT7  |         |
| SXF        | 250-450-505                     | 2007        | OEM - Bi-Material      | Black-K Orange   | R-CRUKTMNRAR7  | € 38,95 |
|            |                                 |             |                        | Black-Neutral    | R-CRUKTMNRNT7  |         |
| SX / SXF   | 125-150-250-350-450             | 2008 > 2022 | OEM - Alloy reinforced | Bi-Material      | R-CRUKTMNRAR7  | € 38,95 |
|            |                                 |             |                        | Alloy reinforced | R-CRUKTMNR016  |         |
| SX / SXF   | 125-150-250-350-450             | 2023        | OEM                    | Black            | R-CRUKTMNR016  | € 38,95 |
|            |                                 |             |                        | K Orange         | R-CRUKTMAR016  |         |
| SXF        | 250-450 Factory Edition         | 2022        | OEM                    | Black            | R-CRUKTMNR023  | € 34,95 |
|            |                                 |             |                        | K Orange         | R-CRUKTMAR023  |         |
| EXC        | 125-200-250-300-400-450-520-525 | 1994 > 2007 | OEM                    | Black            | R-CRUKTMNR023  | € 34,95 |
|            |                                 |             |                        | K Orange         | R-CRUKTMAR023  |         |
| EXC / EXCF | 125-150-250-350-450-            | 2008 > 2013 | OEM - Bi-Material      | Black            | R-CRUKTMNR000  | € 25,95 |
|            |                                 |             |                        | Black-Neutral    | R-CRUKTMNR000  |         |
| EXC / EXCF | 125-150-250-350-450-            | 2008 > 2013 | OEM - Bi-Material      | Black-Neutral    | R-CRUKTMNRNT7  | € 38,95 |
|            |                                 |             |                        | Black-K Orange   | R-CRUKTMNRAR7  |         |
| EXC / EXCF | 125-150-250-350-450-500         | 2014 > 2023 | OEM - Bi-Material      | Black-Neutral    | R-CRUKTMNRNT14 | € 38,95 |
|            |                                 |             |                        | Black-K Orange   | R-CRUKTMNRAR14 |         |
| XC-W       | 125-150-250-300                 | 2014 > 2023 | OEM - Bi-Material      | Black-Neutral    | R-CRUKTMNRNT14 | € 38,95 |
|            |                                 |             |                        | Black-K Orange   | R-CRUKTMNRAR14 |         |
| XC/XC-F    | 125-150-250-300-350-450         | 2008 > 2022 | OEM - Alloy reinforced | Bi-Material      | R-CRUKTMNRNT14 | € 38,95 |
|            |                                 |             |                        | Alloy reinforced | R-CRUKTMNRAR14 |         |
| XC/XC-F    | 125-150-250-350-450             | 2023        | OEM                    | Black            | R-CRUKTMNR016  | € 38,95 |
|            |                                 |             |                        | K Orange         | R-CRUKTMAR016  |         |
| XC/XC-F    | 125-150-250-350-450             | 2023        | OEM                    | Black            | R-CRUKTMNR023  | € 34,95 |
|            |                                 |             |                        | K Orange         | R-CRUKTMAR023  |         |

## KTM REAR SHOCK MUD FLAP / PARASPRUZZI MONOAMMORTIZZATORE

K Orange
  Black

**OEM** original color

| MODEL        | CC                                    | YEAR        | NOTES | COLOR    | CODE          | PRICE   |
|--------------|---------------------------------------|-------------|-------|----------|---------------|---------|
| SX           | 65                                    | 2016 > 2023 | OEM   | Black    | R-PSPKTMNR165 | € 18,95 |
|              |                                       |             |       | K Orange | R-PSPKTMAR165 |         |
| SX           | 85                                    | 2003 > 2012 | OEM   | Black    | R-PSPKTMNR085 | € 14,95 |
|              |                                       |             |       | Black    | R-PSPKTMNR985 |         |
| SX           | 85                                    | 2013 > 2017 | OEM   | Black    | R-PSPKTMNR185 | € 14,95 |
|              |                                       |             |       | Black    | R-PSPKTMNR185 |         |
| SX           | 125-200-250-400-450-520-525           | 1998 > 2006 | OEM   | K Orange | R-PSPKTMAR185 | € 14,95 |
|              |                                       |             |       | Black    | R-PSPKTMNR000 |         |
| SX           | 125-144-150                           | 2007 > 2015 | OEM   | Black    | R-PSPKTMNR007 | € 14,95 |
|              |                                       |             |       | K Orange | R-PSPKTMAR007 |         |
| SX           | 250                                   | 2007 > 2016 | OEM   | Black    | R-PSPKTMNR007 | € 14,95 |
|              |                                       |             |       | K Orange | R-PSPKTMAR007 |         |
| SX           | 250                                   | 2017 > 2022 | OEM   | Black    | R-PSPKTMNR016 | € 14,95 |
|              |                                       |             |       | K Orange | R-PSPKTMAR016 |         |
| SXF          | 250-350-450                           | 2007 > 2015 | OEM   | Black    | R-PSPKTMNR007 | € 14,95 |
|              |                                       |             |       | K Orange | R-PSPKTMAR007 |         |
| SX / SXF     | 125-150-250F-350F-450F                | 2016 > 2022 | OEM   | Black    | R-PSPKTMNR016 | € 14,95 |
|              |                                       |             |       | K Orange | R-PSPKTMAR016 |         |
| SX / SXF     | 125-150-250F-350F-450F                | 2023        | OEM   | Black    | R-PSPKTMNR023 | € 12,95 |
|              |                                       |             |       | K Orange | R-PSPKTMAR023 |         |
| SXF          | 250-450 Factory Edition               | 2022        | OEM   | Black    | R-PSPKTMNR023 | € 12,95 |
|              |                                       |             |       | K Orange | R-PSPKTMAR023 |         |
| EXC / EXCF   | 125-200-250-250F-300-400-520-525      | 1998 > 2007 | OEM   | Black    | R-PSPKTMNR000 | € 14,95 |
|              |                                       |             |       | Black    | R-PSPKTMNR000 |         |
| EXC / EXCF   | 125-200-250-250F-300-350F-400-500-530 | 2008 > 2016 | OEM   | Black    | R-PSPKTMNR007 | € 14,95 |
|              |                                       |             |       | K Orange | R-PSPKTMAR007 |         |
| EXC / EXCF   | 250 > 500                             | 2017 > 2023 | OEM   | Black    | R-PSPKTMNR016 | € 14,95 |
|              |                                       |             |       | K Orange | R-PSPKTMAR016 |         |
| XC-W/-XC-F-W | 125 > 300                             | 2017 > 2023 | OEM   | Black    | R-PSPKTMNR016 | € 14,95 |
|              |                                       |             |       | K Orange | R-PSPKTMAR016 |         |
| XC/XC-F      | 125-150-250-300-350-450               | 2017 > 2022 | OEM   | Black    | R-PSPKTMNR016 | € 14,95 |
|              |                                       |             |       | K Orange | R-PSPKTMAR016 |         |
| XC/XC-F      | 125-150-250-300-350-450               | 2023        | OEM   | Black    | R-PSPKTMNR023 | € 12,95 |
|              |                                       |             |       | K Orange | R-PSPKTMAR023 |         |

## KTM CHAIN SLIDER / SLITTA SCORRICATENA FORCELLONE



### AVAILABLE COLORS

R-SLIKTMAR012

R-SLIKTMNR012

K Orange Black

OEM original color

| MODEL      | CC                                | YEAR        | NOTES          | COLOR    | CODE          | PRICE   |
|------------|-----------------------------------|-------------|----------------|----------|---------------|---------|
| SX         | 65                                | 2016 > 2023 | OEM            | Black    | R-SLIKTMNR165 | € 25,95 |
|            |                                   |             |                | K Orange | R-SLIKTMAR165 |         |
| SX         | 85                                | 2003 > 2014 | OEM            | Black    | R-SLIKTMNR085 | € 25,95 |
|            |                                   |             |                | K Orange | R-SLIKTMAR085 |         |
| SX         | 85                                | 2015 > 2023 | OEM            | Black    | R-SLIKTMNR185 | € 25,95 |
|            |                                   |             |                | K Orange | R-SLIKTMAR185 |         |
| SX / SXF   | 125-200-250-400-450-520-525       | 1997 > 2006 | OEM            | Black    | R-SLIKTMNR000 | € 25,95 |
|            |                                   |             |                | K Orange | R-SLIKTMAR000 |         |
| SX         | 125-144-150-250                   | 2007 > 2010 | OEM            | Black    | R-SLIKTMNR007 | € 25,95 |
|            |                                   |             |                | K Orange | R-SLIKTMAR007 |         |
| SXF        | 250-450-505-525                   | 2007 > 2010 | OEM            | Black    | R-SLIKTMNR007 | € 25,95 |
|            |                                   |             |                | K Orange | R-SLIKTMAR007 |         |
| SX / SXF   | 125-150-250-250F-350F-450         | 2011 > 2022 | OEM            | Black    | R-SLIKTMNR011 | € 25,95 |
|            |                                   |             |                | K Orange | R-SLIKTMAR011 |         |
| SX / SXF   | 125-250-300-350-450               | 2023        | <b>NEW</b> OEM | Black    | R-SLIKTMNR023 | € 22,95 |
|            |                                   |             |                | K Orange | R-SLIKTMAR023 |         |
| SXF        | 250-450 Factory Edition           | 2022        | OEM            | Black    | R-SLIKTMNR023 | € 22,95 |
|            |                                   |             |                | K Orange | R-SLIKTMAR023 |         |
| EXC / EXCF | 125-200-250-300-400-450-520-525   | 1997 > 2007 | OEM            | Black    | R-SLIKTMNR000 | € 25,95 |
|            |                                   |             |                | K Orange | R-SLIKTMAR000 |         |
| EXC / EXCF | 125-150-250-350-450-500-530       | 2008 > 2011 | OEM            | Black    | R-SLIKTMNR007 | € 25,95 |
|            |                                   |             |                | K Orange | R-SLIKTMAR007 |         |
| EXC / EXCF | 125-200-250-250F-300-350F-450-500 | 2011 > 2023 | OEM            | Black    | R-SLIKTMNR012 | € 25,95 |
|            |                                   |             |                | K Orange | R-SLIKTMAR012 |         |
| XC-W/XCF-W | 125 > 300                         | 2011 > 2023 | OEM            | Black    | R-SLIKTMNR012 | € 25,95 |
|            |                                   |             |                | K Orange | R-SLIKTMAR012 |         |
| XC / XC-F  | 125-150-250-300-350-450           | 2017 > 2022 | OEM            | Black    | R-SLIKTMNR011 | € 25,95 |
|            |                                   |             |                | K Orange | R-SLIKTMAR011 |         |
| XC / XC-F  | 125-250-300-350-450               | 2023        | <b>NEW</b> OEM | Black    | R-SLIKTMNR023 | € 22,95 |
|            |                                   |             |                | K Orange | R-SLIKTMAR023 |         |

## KTM CHAIN PAD / PATTINO SCORRICATENA

### AVAILABLE COLORS

K Orange Black

OEM original color

| MODEL      | CC                                   | YEAR        | NOTES          | COLOR    | CODE          | PRICE  |
|------------|--------------------------------------|-------------|----------------|----------|---------------|--------|
| SX         | 65                                   | 2011 > 2023 | OEM            | Black    | R-PATTKTMNR01 | € 9,95 |
|            |                                      |             |                | K Orange | R-PATTKTMAR01 |        |
| SX         | 85                                   | 2018 > 2023 | OEM            | Black    | R-PATTKTMNR11 | € 9,95 |
|            |                                      |             |                | K Orange | R-PATTKTMAR11 |        |
| SX / SXF   | 125 > 525                            | 2000 > 2010 | OEM            | Black    | R-PATTKTMNR01 | € 9,95 |
|            |                                      |             |                | K Orange | R-PATTKTMAR01 |        |
| SX         | 125                                  | 2012 > 2015 | OEM            | Black    | R-PATTKTMNR11 | € 9,95 |
|            |                                      |             |                | K Orange | R-PATTKTMAR11 |        |
| SX         | 125-150                              | 2016 > 2022 | OEM            | Black    | R-PATTKTMNR16 | € 9,95 |
|            |                                      |             |                | K Orange | R-PATTKTMAR16 |        |
| SX         | 250                                  | 2012 > 2016 | OEM            | Black    | R-PATTKTMNR11 | € 9,95 |
|            |                                      |             |                | K Orange | R-PATTKTMAR11 |        |
| SX         | 250                                  | 2017 > 2022 | OEM            | Black    | R-PATTKTMNR16 | € 9,95 |
|            |                                      |             |                | K Orange | R-PATTKTMAR16 |        |
| SXF        | 250-350-450                          | 2012 > 2015 | OEM            | Black    | R-PATTKTMNR11 | € 9,95 |
|            |                                      |             |                | K Orange | R-PATTKTMAR11 |        |
| SXF        | 250-350-450                          | 2016 > 2022 | OEM            | Black    | R-PATTKTMNR16 | € 9,95 |
|            |                                      |             |                | K Orange | R-PATTKTMAR16 |        |
| SX / SXF   | 125-250-300-350-450                  | 2023        | <b>NEW</b> OEM | Black    | R-PATTKTMNR23 | € 8,95 |
|            |                                      |             |                | K Orange | R-PATTKTMAR23 |        |
| SX / SXF   | 250-450 Factory Edition              | 2022        | OEM            | Black    | R-PATTKTMNR23 | € 8,95 |
|            |                                      |             |                | K Orange | R-PATTKTMAR23 |        |
| EXC / EXCF | 125-200-250-250F-300-400-450-525-530 | 2000 > 2011 | OEM            | Black    | R-PATTKTMNR01 | € 9,95 |
|            |                                      |             |                | K Orange | R-PATTKTMAR01 |        |
| EXC / EXCF | 125-200-250-250F-300-350F-450-500    | 2012 > 2023 | OEM            | Black    | R-PATTKTMNR11 | € 9,95 |
|            |                                      |             |                | K Orange | R-PATTKTMAR11 |        |
| XC-W/XCF-W | 125 > 300                            | 2012 > 2023 | OEM            | Black    | R-PATTKTMNR11 | € 9,95 |
|            |                                      |             |                | K Orange | R-PATTKTMAR11 |        |
| XC / XC-F  | 250-300-350-450                      | 2017 > 2022 | OEM            | Black    | R-PATTKTMNR16 | € 9,95 |
|            |                                      |             |                | K Orange | R-PATTKTMAR16 |        |
| XC / XC-F  | 125-250-300-350-450                  | 2023        | <b>NEW</b> OEM | Black    | R-PATTKTMNR23 | € 8,95 |
|            |                                      |             |                | K Orange | R-PATTKTMAR23 |        |

# KTM REPLICA PLASTICS KIT / KIT PLASTICHE REPLICA



R-KITKTM-OEM-599











































































**OEM** original color -  fluorescent color

| MODEL              | CC          | YEAR             | NOTES   | COLOR               |       | CODE             | PRICE    |  |          |                  |                  |          |
|--------------------|-------------|------------------|---|---------------------|-------|------------------|----------|--|----------|------------------|------------------|----------|
| <b>SX</b>          | 50          | 2016 > 2023      |   | K Orange            |       | R-KITKTM-AR0-050 | € 124,95 |  |          |                  |                  |          |
|                    |             |                  |   | White               |       | R-KITKTM-BN0-050 |          |  |          |                  |                  |          |
|                    |             |                  |   | Black               |       | R-KITKTM-NR0-050 |          |  |          |                  |                  |          |
|                    |             |                  |   | Orange-Black-White  |       | R-KITKTM-AR1-050 |          |  |          |                  |                  |          |
|                    |             |                  |   | Orange-White-Black  |       | R-KITKTM-AR2-050 |          |  |          |                  |                  |          |
|                    |             |                  |   | Orange-White-White  |       | R-KITKTM-AR3-050 |          |  |          |                  |                  |          |
|                    |             |                  |   | White-Orange        |       | R-KITKTM-AR4-050 |          |  |          |                  |                  |          |
|                    |             |                  |   | Orange-White        |       | R-KITKTM-AR5-050 |          |  |          |                  |                  |          |
|                    |             |                  |   | <b>SX-E</b>         | 3 - 5 | 2020 > 2023      |          | OEM 2020 > 2022  | K Orange |                  | R-KITKTM-AR0-050 | € 124,95 |
|                    |             |                  |   |                     |       |                  |          |  | White    |                  | R-KITKTM-BN0-050 |          |
| Black              |             | R-KITKTM-NR0-050 |   |                     |       |                  |          |  |          |                  |                  |          |
| Orange-Black-White |             | R-KITKTM-AR1-050 |   |                     |       |                  |          |  |          |                  |                  |          |
| Orange-White-Black |             | R-KITKTM-AR2-050 |   |                     |       |                  |          |  |          |                  |                  |          |
| Orange-White-White |             | R-KITKTM-AR3-050 |   |                     |       |                  |          |  |          |                  |                  |          |
| White-Orange       |             | R-KITKTM-AR4-050 |   |                     |       |                  |          |  |          |                  |                  |          |
| Orange-White       |             | R-KITKTM-AR5-050 |   |                     |       |                  |          |  |          |                  |                  |          |
| <b>SX</b>          | 65          | 2002 > 2008      | OEM 2023  |                     |       |                  | OEM      |  |          | R-KITKTM-AR0-506 | € 134,95         |          |
|                    |             |                  |   |                     |       |                  | White    |  |          | R-KITKTM-BN0-506 |                  |          |
| <b>SX</b>          | 65          | 2009 > 2011      | OEM 2011  | Black               |       | R-KITKTM-NR0-506 | € 134,95 |  |          |                  |                  |          |
|                    |             |                  |   | OEM                 |       | R-KITKTM-O11-508 |          |  |          |                  |                  |          |
| <b>SX</b>          | 65          | 2012 > 2015      | OEM 2013 > 15   | White               |       | R-KITKTM-BN0-508 | € 134,95 |  |          |                  |                  |          |
|                    |             |                  |   | Black               |       | R-KITKTM-NR0-508 |          |  |          |                  |                  |          |
| <b>SX</b>          | 65          | 2016 > 2023      | OEM 2019 > 2022 Orange/White<br>OEM 2017<br>OEM 2016 and 2018<br>OEM 2023         | OEM                 |       | R-KITKTM-OEM-511 | € 134,95 |  |          |                  |                  |          |
|                    |             |                  |   | White               |       | R-KITKTM-BN0-511 |          |  |          |                  |                  |          |
|                    |             |                  |   | Black               |       | R-KITKTM-NR0-511 |          |  |          |                  |                  |          |
|                    |             |                  |   | OEM                 |       | R-KITKTM-O19-500 |          |  |          |                  |                  |          |
|                    |             |                  |   | OEM                 |       | R-KITKTM-O17-500 |          |  |          |                  |                  |          |
|                    |             |                  |   | OEM                 |       | R-KITKTM-O16-500 |          |  |          |                  |                  |          |
|                    |             |                  |   | Orange-White        |       | R-KITKTM-O23-500 |          |  |          |                  |                  |          |
|                    |             |                  |   | White               |       | R-KITKTM-BN0-500 |          |  |          |                  |                  |          |
| <b>SX</b>          | 85          | 2006 > 2012      | OEM 2011-2012 - adaptable from 2003<br>adaptable from 2003<br>adaptable from 2003 | OEM                 |       | R-KITKTM-O11-507 | € 134,95 |  |          |                  |                  |          |
|                    |             |                  |   | K Orange            |       | R-KITKTM-AR0-507 |          |  |          |                  |                  |          |
|                    |             |                  |   | White               |       | R-KITKTM-BN0-507 |          |  |          |                  |                  |          |
|                    |             |                  |   | Black               |       | R-KITKTM-NR0-507 |          |  |          |                  |                  |          |
|                    |             |                  |   | <b>SX</b>           | 85    | 2013 > 2017      |          | OEM 2017 - Left air box cover included<br>OEM 2016 - Left air box cover included<br>OEM 2015 - Left air box cover included<br>Left air box cover included<br>Left air box cover included | OEM      |                  | R-KITKTM-OEM-533 | € 134,95 |
|                    |             |                  |   |                     |       |                  |          |  | OEM      |                  | R-KITKTM-OEM-523 |          |
|                    |             |                  |   |                     |       |                  |          |  | OEM      |                  | R-KITKTM-OEM-593 |          |
|                    |             |                  |   |                     |       |                  |          |  | White    |                  | R-KITKTM-BN0-513 |          |
| <b>SX</b>          | 85          | 2018 > 2023      | OEM 2018<br>OEM 2019 > 2022<br>OEM 2023   | Black               |       | R-KITKTM-NR0-513 | € 147,95 |  |          |                  |                  |          |
|                    |             |                  |   | OEM                 |       | R-KITKTM-OEM-185 |          |  |          |                  |                  |          |
|                    |             |                  |   | OEM                 |       | R-KITKTM-OEM-285 |          |  |          |                  |                  |          |
|                    |             |                  |   | OEM                 |       | R-KITKTM-OEM-385 |          |  |          |                  |                  |          |
|                    |             |                  |   | K Orange            |       | R-KITKTM-AR0-185 |          |  |          |                  |                  |          |
|                    |             |                  |   | White               |       | R-KITKTM-BN0-185 |          |  |          |                  |                  |          |
|                    |             |                  |   | Black               |       | R-KITKTM-NR0-185 |          |  |          |                  |                  |          |
|                    |             |                  |   | Neon Orange         |       | R-KITKTM-AN0-185 |          |  |          |                  |                  |          |
| <b>SX / SXF</b>    | 400-520     | 2000             | With Light Blue Fork protectors   | Neon Yellow         |       | R-KITKTM-GF0-185 | € 147,95 |  |          |                  |                  |          |
|                    |             |                  |   | Light Blue-K Orange |       | R-KITKTM-CLO-185 |          | € 159,95   |          |                  |                  |          |
| <b>SX / SXF</b>    | 250 2T-450  | 2001-2002        |   | OEM                 |       | R-KITKTM-AR0-501 | € 134,95 |  |          |                  |                  |          |
|                    |             |                  |   | Black               |       | R-KITKTM-NR0-501 |          |  |          |                  |                  |          |
| <b>SX / SXF</b>    | 125-520-525 | 2001 > 2003      |   | OEM                 |       | R-KITKTM-AR0-502 | € 134,95 |  |          |                  |                  |          |
|                    |             |                  |   | Black               |       | R-KITKTM-NR0-502 |          |  |          |                  |                  |          |
| <b>SX / SXF</b>    | 250-450     | 2003             |   | K Orange            |       | R-KITKTM-AR0-502 | € 134,95 |  |          |                  |                  |          |
|                    |             |                  |   | Black               |       | R-KITKTM-NR0-502 |          |  |          |                  |                  |          |
| <b>SX / SXF</b>    | 250-450     | 2003             |   | OEM                 |       | R-KITKTM-AR0-503 | € 134,95 |  |          |                  |                  |          |
|                    |             |                  |   | Black               |       | R-KITKTM-NR0-503 |          |  |          |                  |                  |          |

**NEW**









**NEW**

OEM original color -  fluorescent color

| MODEL                                  | CC  | YEAR             | NOTES   | COLOR  |   | CODE             | PRICE   |
|--|---|------------------|---|--|---|------------------|---|
| SX / SXF                               | 125-200-250-400-450-520-525   | 2004             |   | OEM  |    | R-KITKTM-ARO-503 | € 134,95  |
|  |   |                  |   | Black  |    | R-KITKTM-NRO-503 |   |
| SX / SXF                               | 125-250-400-450-520-525   | 2005-2006        |   | OEM  |    | R-KITKTM-ARO-504 | € 134,95  |
|  |   |                  |   | White  |    | R-KITKTM-BNO-504 |   |
|  |   |                  |   | Black  |  | R-KITKTM-NRO-504 |   |
| SX / SXF                               | 125-250-450-505   | 2007 > 2010      | OEM 2009-2010   | OEM  |    | R-KITKTM-OEM-505 | € 134,95  |
|  |   |                  |   | OEM  |    | R-KITKTM-O11-505 |   |
|  |   |                  |   | K Orange   |  | R-KITKTM-ARO-505 |   |
|  |   |                  |   | White  |  | R-KITKTM-BNO-505 |   |
|  |   |                  |   | Black  |  | R-KITKTM-NRO-505 |   |
|  |   |                  |   | OEM  |  | R-KITKTM-OEM-519 | € 134,95  |
| SX                                     | 125-150-250   | 2011             | OEM - PDS version includes air box covers<br>PDS version includes air box covers<br>PDS version includes air box covers   | White  |    | R-KITKTM-BNO-519 |   |
|  |   |                  |   | Black  |    | R-KITKTM-NRO-519 |   |
|  |   |                  |   | OEM  |  | R-KITKTM-OEM-509 | € 134,95  |
| SX                                     | 125-150-250   | 2012             | OEM - LINK version includes air box covers<br>LINK version includes air box covers<br>LINK version includes air box covers  | White  |    | R-KITKTM-BNO-509 |   |
|  |   |                  |   | Black  |    | R-KITKTM-NRO-509 |   |
|  |   |                  |   | OEM  |  | R-KITKTM-OEM-509 | € 134,95  |
| SXF                                    | 250-350-450   | 2011-2012        | OEM - LINK version includes air box covers<br>LINK version includes air box covers<br>LINK version includes air box covers  | White  |    | R-KITKTM-BNO-509 | € 134,95  |
|  |   |                  |   | Black  |    | R-KITKTM-NRO-509 |   |
|  |   |                  |   | OEM  |  | R-KITKTM-OEM-594 | € 134,95  |
| SX<br>kit includes vented front fender | 125-150   | 2013 > 2015      | OEM 2016 - Air box covers includes<br>OEM 2015 - Air box covers includes<br>OEM 2013-14 Air box covers includes<br>Air box covers includes<br>Air box covers includes | OEM  |    | R-KITKTM-OEM-592 |   |
|  |   |                  |   | OEM  |    | R-KITKTM-OEM-592 |   |
|  |   |                  |   | OEM  |  | R-KITKTM-OEM-512 |   |
|  |   |                  |   | White-Black  |  | R-KITKTM-BNO-512 |   |
|  |   |                  |   | Black  |  | R-KITKTM-NRO-512 |   |
| SX                                     | 125-150-250   | 2019 > 2022      | OEM 2019-2020-2022<br>OEM 2021<br>Limited Edition   | OEM  |    | R-KITKTM-OEM-599 | € 159,95  |
|  |   |                  |   | OEM  |    | R-KITKTM-OEM-600 | € 159,95  |
|  |   |                  |   | Orange-Blue-White  |  | R-KITKTM-OEM-601 | € 159,95  |
|  |   |                  |   | White  |  | R-KITKTM-BNO-599 | € 159,95  |
|  |   |                  |   | Black  |  | R-KITKTM-NRO-599 | € 159,95  |
|  |   |                  |   | K Orange   |  | R-KITKTM-ARO-599 | € 159,95  |
|  |   |                  |   |  Neon Orange                      |    | R-KITKTM-ANO-599 | € 159,95  |
|  |   |                  |   |  Neon Yellow                      |    | R-KITKTM-GFO-599 | € 159,95  |
|  |   |                  |   | Light Blue-K Orange  |    | R-KITKTM-CLO-599 | € 159,95  |
|  |   |                  |   | Quantum Grey   |    | R-KITKTM-GR0-599 | € 159,95  |
|  |   |                  |   |  Ducati Neon Red                  |    | R-KITKTM-RD0-599 | € 172,95  |
|  |   |                  |   | OEM  |    | R-KITKTM-OEM-609 | € 172,95  |
|  |   |                  |   | OEM  |  | R-KITKTM-OEM-594 | € 134,95  |
|  |   |                  |   | OEM  |  | R-KITKTM-OEM-592 |   |
|  |   |                  |   | White-Black  |  | R-KITKTM-BNO-512 |   |
| Black                                  |  | R-KITKTM-NRO-512 |   |  |   |                  |   |
| SX<br>kit includes vented front fender | 250   | 2017-2018        | OEM 2018<br>OEM 2017  | OEM  |    | R-KITKTM-OEM-536 | € 159,95  |
|  |   |                  |   | OEM  |    | R-KITKTM-OEM-526 | € 159,95  |
|  |   |                  |   | Orange-White   |  | R-KITKTM-OEM-516 | € 159,95  |
|  |   |                  |   | White-Black  |  | R-KITKTM-BNO-516 | € 159,95  |
|  |   |                  |   | White  |  | R-KITKTM-BN1-516 | € 159,95  |
|  |   |                  |   | Black  |  | R-KITKTM-NRO-516 | € 159,95  |
|  |   |                  |   |  Neon Yellow                      |    | R-KITKTM-GFO-516 | € 159,95  |
|  |   |                  |   |  Neon Orange                      |    | R-KITKTM-ANO-516 | € 159,95  |
|  |   |                  |   | FULL ORANGE Factory Edition  |    | R-KITKTM-US1-516 | € 159,95  |
|  |   |                  |   | K Orange   |    | R-KITKTM-GR0-516 | € 159,95  |
|  |   |                  |   | Quantum Grey   |    | R-KITKTM-CLO-518 | € 172,95  |
|  |   |                  |   | Light Blue-K Orange  |    | R-KITKTM-OEM-536 | € 159,95  |
| SX<br>kit includes vented front fender | 125-150   | 2016 > 2018      | OEM 2018<br>OEM 2017<br>OEM 2016  | OEM  |    | R-KITKTM-OEM-526 | € 159,95  |
|  |   |                  |   | OEM  |    | R-KITKTM-OEM-516 | € 159,95  |
|  |   |                  |   | White-Black  |  | R-KITKTM-BNO-516 | € 159,95  |
|  |   |                  |   | White  |  | R-KITKTM-BN1-516 | € 159,95  |
|  |   |                  |   | Black  |  | R-KITKTM-NRO-516 | € 159,95  |
|  |   |                  |   |  Neon Yellow                      |    | R-KITKTM-GFO-516 | € 159,95  |
|  |   |                  |   | Orange   |    | R-KITKTM-US1-516 | € 159,95  |
|  |   |                  |   | Quantum Grey   |    | R-KITKTM-GR0-516 | € 159,95  |
|  |   |                  |   |  Neon Orange                      |    | R-KITKTM-ANO-516 | € 159,95  |
|  |   |                  |   | Light Blue-K Orange  |    | R-KITKTM-CLO-518 | € 172,95  |
|  |   |                  |   | With Light Blue Fork protectors  |    | R-KITKTM-OEM-594 | € 134,95  |
|  |   |                  |   | SXF<br>kit includes vented front fender  | 250-350-450   | 2013 > 2015      | OEM 2016 - Air box covers includes<br>OEM 2015 - Air box covers includes<br>OEM 2013-2014 - Air box covers includes<br>Air box covers includes<br>Air box covers includes |
| OEM                                    |    | R-KITKTM-OEM-512 |   |  |   |                  |   |
| White-Black                            |  | R-KITKTM-BNO-512 |   |  |   |                  |   |
| Black                                  |  | R-KITKTM-NRO-512 |   |  |   |                  |   |
| OEM                                    |  | R-KITKTM-OEM-592 |   |  |   |                  |   |

# KTM REPLICA PLASTICS KIT / KIT PLASTICHE REPLICA

OEM original color -  fluorescent color

| MODEL   | CC                               | YEAR             | NOTES   | COLOR   | CODE             | PRICE            |  |
|---|----------------------------------|------------------|---|---|------------------|------------------|--|
| SXF<br>kit includes vented front fender   | 250-350-450                      | 2016 > 2018      | OEM 2018<br>OEM 2017<br>OEM 2016                    | OEM   | R-KITKTM-OEM-536 | € 159,95         |  |
|   |                                  |                  |   | OEM   | R-KITKTM-OEM-526 | € 159,95         |  |
|   |                                  |                  |   | OEM   | R-KITKTM-OEM-516 | € 159,95         |  |
|   |                                  |                  |   | White-Black   | R-KITKTM-BN0-516 | € 159,95         |  |
|   |                                  |                  |   | White   | R-KITKTM-BN1-516 | € 159,95         |  |
|   |                                  |                  |   | Black   | R-KITKTM-NR0-516 | € 159,95         |  |
|   |                                  |                  |   | Neon Yellow   | R-KITKTM-GF0-516 | € 159,95         |  |
|   |                                  |                  |   | Orange  | R-KITKTM-US1-516 | € 159,95         |  |
|   |                                  |                  |   | Quantum Grey  | R-KITKTM-GR0-516 | € 159,95         |  |
|   |                                  |                  |   | Neon Orange   | R-KITKTM-ANO-516 | € 159,95         |  |
|   |                                  |                  |   | Light Blue-K Orange   | R-KITKTM-CLO-518 | € 172,95         |  |
|   |                                  |                  |   | With Light Blue Fork protectors            |                  |                  |  |
|   |                                  |                  |   | SXF   | 250-350-450      | 2019 > 2022      | OEM 2019-2020<br>OEM 2021<br>Limited Edition |
| OEM   | R-KITKTM-OEM-600                 | € 159,95         |   |   |                  |                  |  |
| Orange-Blue-White   | R-KITKTM-OEM-601                 | € 159,95         |   |   |                  |                  |  |
| White   | R-KITKTM-BN0-599                 | € 159,95         |   |   |                  |                  |  |
| Black   | R-KITKTM-NR0-599                 | € 159,95         |   |   |                  |                  |  |
| K Orange  | R-KITKTM-ARO-599                 | € 159,95         |   |   |                  |                  |  |
| Neon Orange   | R-KITKTM-ANO-599                 | € 159,95         |   |   |                  |                  |  |
| Neon Yellow   | R-KITKTM-GFO-599                 | € 159,95         |   |   |                  |                  |  |
| Orange Light Blue   | R-KITKTM-CLO-599                 | € 159,95         |   |   |                  |                  |  |
| Quantum Grey  | R-KITKTM-GR0-599                 | € 159,95         |   |   |                  |                  |  |
| Limited Edition - With Fork protectors   | Ducati Neon Red                  | R-KITKTM-RDO-599 | € 172,95  |   |                  |                  |  |
| OEM 2019-2020-2022 With Fork protectors  | OEM                              | R-KITKTM-OEM-609 | € 172,95  |   |                  |                  |  |
| SXF   | 450 Factory Edition              | 2018 > 2021      | 2018 Factory Edition<br>OEM 2021<br>Limited Edition |   |                  |                  |  |
|   |                                  |                  |   | OEM   | R-KITKTM-OEM-600 | € 159,95         |  |
|   |                                  |                  |   | Orange-Blue-White   | R-KITKTM-OEM-601 | € 159,95         |  |
|   |                                  |                  |   | White   | R-KITKTM-BN0-599 | € 159,95         |  |
|   |                                  |                  |   | Black   | R-KITKTM-NR0-599 | € 159,95         |  |
|   |                                  |                  |   | K Orange  | R-KITKTM-ARO-599 | € 159,95         |  |
|   |                                  |                  |   | Neon Orange   | R-KITKTM-ANO-599 | € 159,95         |  |
|   |                                  |                  |   | Neon Yellow   | R-KITKTM-GFO-599 | € 159,95         |  |
|   |                                  |                  |   | Light Blue-K Orange   | R-KITKTM-CLO-599 | € 159,95         |  |
|   |                                  |                  |   | Quantum Grey  | R-KITKTM-GR0-599 | € 159,95         |  |
|   |                                  |                  |   | Limited Edition - With Fork protectors   | Ducati Neon Red  | R-KITKTM-RDO-599 | € 172,95                                     |
|   |                                  |                  |   | OEM 2019-2020-2022 With Fork protectors  | OEM              | R-KITKTM-OEM-609 | € 172,95                                     |
|   |                                  |                  |   | XC / XC-F<br>kit includes vented front fender   | 250-300-350-450  | 2017-2018        | OEM 2018<br>OEM 2017                         |
| OEM   | R-KITKTM-OEM-526                 | € 159,95         |   |   |                  |                  |  |
| Orange-White  | R-KITKTM-OEM-516                 | € 159,95         |   |   |                  |                  |  |
| White-Black   | R-KITKTM-BN0-516                 | € 159,95         |   |   |                  |                  |  |
| White   | R-KITKTM-BN1-516                 | € 159,95         |   |   |                  |                  |  |
| Black   | R-KITKTM-NR0-516                 | € 159,95         |   |   |                  |                  |  |
| Neon Yellow   | R-KITKTM-GF0-516                 | € 159,95         |   |   |                  |                  |  |
| Neon Orange   | R-KITKTM-ANO-516                 | € 159,95         |   |   |                  |                  |  |
| K Orange  | R-KITKTM-US1-516                 | € 159,95         |   |   |                  |                  |  |
| Quantum Grey  | R-KITKTM-GR0-516                 | € 159,95         |   |   |                  |                  |  |
| Light Blue-K Orange   | R-KITKTM-CLO-518                 | € 172,95         |   |   |                  |                  |  |
| Full Orange Factory Edition   | Ducati Neon Red                  | R-KITKTM-RDO-599 | € 172,95  |   |                  |                  |  |
| With Light Blue Fork protectors        |                                  |                  |   |   |                  |                  |  |
| XC / XC-F   | 250-300-350-450                  | 2019 > 2022      | OEM 2019-2020<br>OEM 2021<br>Limited Edition        | OEM   | R-KITKTM-OEM-599 | € 159,95         |  |
|   |                                  |                  |   | OEM   | R-KITKTM-OEM-600 | € 159,95         |  |
|   |                                  |                  |   | Orange-Blue-White   | R-KITKTM-OEM-601 | € 159,95         |  |
|   |                                  |                  |   | White   | R-KITKTM-BN0-599 | € 159,95         |  |
|   |                                  |                  |   | Black   | R-KITKTM-NR0-599 | € 159,95         |  |
|   |                                  |                  |   | K Orange  | R-KITKTM-ARO-599 | € 159,95         |  |
|   |                                  |                  |   | Neon Orange   | R-KITKTM-ANO-599 | € 159,95         |  |
|   |                                  |                  |   | Neon Yellow   | R-KITKTM-GFO-599 | € 159,95         |  |
|   |                                  |                  |   | Light Blue-K Orange   | R-KITKTM-CLO-599 | € 159,95         |  |
|   |                                  |                  |   | Quantum Grey  | R-KITKTM-GR0-599 | € 159,95         |  |
|   |                                  |                  |   | Limited Edition - With Fork protectors   | Ducati Neon Red  | R-KITKTM-RDO-599 | € 172,95                                     |
|   |                                  |                  |   | OEM 2019-2020-2022 With Fork protectors  | OEM              | R-KITKTM-OEM-609 | € 172,95                                     |
|   |                                  |                  |   | EXC / EXCF  | 125 > 520        | 2000 > 2002      |  |
| Black   | R-KITKTM-NR0-501                 | € 134,95         |   |   |                  |                  |  |
| EXC / EXCF  | 125-250-250F-300-400-450-520-525 | 2003             |   | OEM   | R-KITKTM-ARO-502 | € 134,95         |  |
|   |                                  |                  |   | Black   | R-KITKTM-NR0-502 | € 134,95         |  |
| EXC / EXCF  | 125-250-250F-300-400-450-520-525 | 2004             |   | OEM   | R-KITKTM-ARO-503 | € 134,95         |  |
|   |                                  |                  |   | Black   | R-KITKTM-NR0-503 | € 134,95         |  |
| EXC / EXCF  | 125-250-250F-300-400-450-520-525 | 2005 > 2007      |   | OEM   | R-KITKTM-ARO-504 | € 134,95         |  |
|   |                                  |                  |   | White   | R-KITKTM-BN0-504 | € 134,95         |  |
| EXC / EXCF  | 125-250-250F-300-400-450-530     | 2008 > 2011      | OEM - EXC 2011<br>OEM 2009-2010                     | OEM   | R-KITKTM-O11-505 | € 134,95         |  |
|   |                                  |                  |   | OEM   | R-KITKTM-OEM-505 | € 134,95         |  |
|   |                                  |                  |   | K Orange  | R-KITKTM-ARO-505 | € 134,95         |  |
|   |                                  |                  |   | White   | R-KITKTM-BN0-505 | € 134,95         |  |
|   |                                  |                  |   | Black   | R-KITKTM-NR0-505 | € 134,95         |  |

OEM original color - ☀ fluorescent color

| MODEL   | CC                          | YEAR        | NOTES   | COLOR                       |             | CODE                                   | PRICE          |  |                  |          |
|---|-----------------------------|-------------|---|-----------------------------|-------------|--|----------------|--|------------------|----------|
| EXC / EXCF  | 125-200-250-300-350-450-500 | 2012-2013   | OEM - Air box covers includes                   | OEM                         |             | R-KITKTM-OEM-412                       | € 124,95       |  |                  |          |
|   |                             |             | Air box covers includes                         | White-Black                 |             | R-KITKTM-BN0-412                       |                |  |                  |          |
|   |                             |             | Air box covers includes                         | Black                       |             | R-KITKTM-NR0-412                       |                |  |                  |          |
| EXC / EXCF  | 125-200-250-300-350-450-500 | 2014 > 2016 | OEM 2015-16 Air box covers includes             | OEM                         |             | R-KITKTM-OEM-495                       | € 124,95       |  |                  |          |
|   |                             |             | OEM 2014 Air box covers includes                | OEM                         |             | R-KITKTM-OEM-415                       |                |  |                  |          |
|   |                             |             | OEM Six Days 2014-2015                          | OEM Six Days                |             | R-KITKTM-BN0-415                       |                |  |                  |          |
|   |                             |             | Air box covers includes                         | Black                       |             | R-KITKTM-NR0-415                       |                |  |                  |          |
|   |                             |             | Air box covers includes                         | ☀ Neon Orange               |             | R-KITKTM-AN0-415                       |                |  |                  |          |
| EXC/EXCF/XC-W   | 125-150-250-300-350-450-500 | 2017 > 2019 | OEM 2017 and 2019 - with left airbox side panel | OEM                         |             | R-KITKTM-OEM-417                       | € 147,95       |  |                  |          |
|   |                             |             | with left airbox side panel                     | K Orange                    |             | R-KITKTM-AR0-417                       | € 147,95       |  |                  |          |
|   |                             |             | OEM Six Days 2018 - with left airbox side panel | OEM Six Days                |             | R-KITKTM-BN0-417                       | € 147,95       |  |                  |          |
|   |                             |             | with left airbox side panel                     | Black                       |             | R-KITKTM-NR0-417                       | € 147,95       |  |                  |          |
|   |                             |             | OEM 2018 - with left airbox side panel          | OEM                         |             | R-KITKTM-OEM-418                       | € 147,95       |  |                  |          |
|   |                             |             | OEM Six Days 2019 - with left airbox side panel | OEM Six Days                |             | R-KITKTM-OEM-488                       | € 147,95       |  |                  |          |
|   |                             |             | with left airbox side panel                     | K Orange                    |             | R-KITKTM-AR0-517                       | € 159,95       |  |                  |          |
|   |                             |             | with left airbox side panel                     | ☀ Neon Orange               |             | R-KITKTM-AN0-517                       | € 159,95       |  |                  |          |
|   |                             |             | OEM Six Days 2017 - with left airbox side panel | OEM Six Days                |             | R-KITKTM-BN0-517                       | € 159,95       |  |                  |          |
|   |                             |             | with left airbox side panel                     | Black                       |             | R-KITKTM-NR0-517                       | € 159,95       |  |                  |          |
|   |                             |             | OEM 2018 - with left airbox side panel          | OEM                         |             | R-KITKTM-OEM-517                       | € 159,95       |  |                  |          |
|   |                             |             | with left airbox side panel                     | ☀ Neon Yellow               |             | R-KITKTM-GF0-517                       | € 159,95       |  |                  |          |
|   |                             |             | with left airbox side panel                     | Quantum Grey                |             | R-KITKTM-GR0-517                       | € 159,95       |  |                  |          |
|   |                             |             | OEM Six Days 2019 - with left airbox side panel | OEM Six Days                |             | R-KITKTM-OEM-588                       | € 159,95       |  |                  |          |
|   |                             |             | OEM 2018 - with left airbox side panel          | K Orange-Black              |             | R-KITKTM-OEM-518                       | € 159,95       |  |                  |          |
|   |                             |             | <b>With Light Blue Fork protectors</b>          | Light Blue-K Orange         |             | R-KITKTM-CLO-528                       | € 172,95       |  |                  |          |
|   |                             |             | EXC / EXCF<br>XC-W/XCF-W                        | 125-150-250-300-350-450-500 | 2020 > 2023 | OEM 2020 - with left airbox side panel | K Orange-Black |  | R-KITKTM-OEM-420 | € 147,95 |
|   |                             |             |   |                             |             | with left airbox side panel            | K Orange       |  | R-KITKTM-AR0-420 | € 147,95 |
|   |                             |             |   |                             |             | OEM - with left airbox side panel      | White          |  | R-KITKTM-BN0-420 | € 147,95 |
|   |                             |             |   |                             |             | with left airbox side panel            | Black          |  | R-KITKTM-NR0-420 | € 147,95 |
| OEM 2021 - with left airbox side panel                | K Orange-Grey               |             |   |                             |             | R-KITKTM-OEM-421                       | € 147,95       |  |                  |          |
| OEM 2022 - with left airbox side panel                | K Orange-Blue               |             |   |                             |             | R-KITKTM-OEM-423                       | € 147,95       |  |                  |          |
| OEM 2023 - with left airbox side panel                | K Orange-White              |             |   |                             |             | R-KITKTM-OEM-433                       | € 147,95       |  |                  |          |
| OEM 2023 - with left airbox side panel                | K Orange-White              |             |   |                             |             | R-KITKTM-OEM-633                       | € 159,95       |  |                  |          |
| OEM Erzberg Rodeo 2023 - with left side panel         | K Orange-Grey               |             |   |                             |             | R-KITKTM-GR2-523                       | € 159,95       |  |                  |          |
| OEM 2020 - with left airbox side panel                | K Orange-Black              |             |   |                             |             | R-KITKTM-OEM-520                       | € 159,95       |  |                  |          |
| OEM Six Days 2021 - with left airbox side panel       | White                       |             |   |                             |             | R-KITKTM-BN0-520                       | € 159,95       |  |                  |          |
| OEM Six Days 2020 - with left airbox side panel       | White-Black                 |             |   |                             |             | R-KITKTM-BN1-520                       | € 159,95       |  |                  |          |
| OEM Erzberg Rodeo 2020 - with left side panel         | White-Black                 |             |   |                             |             | R-KITKTM-BN2-520                       | € 159,95       |  |                  |          |
| with left airbox side panel                           | Black                       |             |   |                             |             | R-KITKTM-NR0-520                       | € 159,95       |  |                  |          |
| with left airbox side panel                           | K Orange                    |             |   |                             |             | R-KITKTM-AR0-520                       | € 159,95       |  |                  |          |
| with left airbox side panel                           | ☀ Neon Orange               |             |   |                             |             | R-KITKTM-AN0-520                       | € 159,95       |  |                  |          |
| with left airbox side panel                           | ☀ Neon Yellow               |             |   |                             |             | R-KITKTM-GF0-520                       | € 159,95       |  |                  |          |
| with left airbox side panel                           | K Orange/Light Blue         |             |   |                             |             | R-KITKTM-CLO-520                       | € 159,95       |  |                  |          |
| with left airbox side panel                           | Quantum Grey                |             |   |                             |             | R-KITKTM-GR0-520                       | € 159,95       |  |                  |          |
| OEM 2021 - with left airbox side panel                | K Orange-Grey               |             |   |                             |             | R-KITKTM-OEM-521                       | € 159,95       |  |                  |          |
| OEM Ezberg Rodeo 2021 - with left airbox side panel   | K Orange-White              |             |   |                             |             | R-KITKTM-OEM-522                       | € 159,95       |  |                  |          |
| OEM 2022 - with left airbox side panel                | K Orange-Blue               |             |   |                             |             | R-KITKTM-OEM-623                       | € 159,95       |  |                  |          |
| WESS 2021 - airbox side panel and fork protectors     | K Orange-Grey               |             |   |                             |             | R-KITKTM-OEM-723                       | € 172,95       |  |                  |          |
| OEM 2023 - airbox side panel and fork protectors      | K Orange-White              |             |   |                             |             | R-KITKTM-OEM-733                       | € 172,95       |  |                  |          |
| SIX DAYS 2023 - airbox side panel and fork protectors | White-Red-Blue              |             |   |                             |             | R-KITKTM-OEM-743                       | € 172,95       |  |                  |          |





## HUSABERG

*Front fender / Parafango anteriore >pag 190*

*Rear fender / Parafango posteriore >pag 190*

*Radiator shrouds / Convogliatori aria radiatore >pag 191*

*Side panels / Tabelle laterali portanumero >pag 191*

*Rear shock mud flap / Paraspruzzi monoammortizzatore >pag 192*

*Chain guide / Cruna guida catena >pag 192*

*Fork protectors / Parasteli forcella >pag 192*

*Chain pads / Pattino scorricatena >pag 193*

*Chain slider / Slitta scorricatena forcellone >pag 193*

*Replica plastics kit / Kit plastiche replica >pag 193*

## HUSABERG FRONT FENDER / PARAFANGO ANTERIORE



R-PAHSQBN9914



R-PAHSQNR9914



R-PAHSQAH9914

### AVAILABLE COLORS

HBG Blue Black White

**OEM** original color

| MODEL       | CC                      | YEAR        | NOTES   | COLOR    | CODE          | PRICE   |
|-------------|-------------------------|-------------|---|----------|---------------|---------|
| FE/FC/FS/FX | 350-400-450-500-650     | 2003 > 2012 | OEM   | HBG Blue | R-PAKTMAH0300 | € 28,95 |
|             |                         |             |   | White    | R-PAKTMBN0300 |         |
|             |                         |             |   | Black    | R-PAKTMNR0300 |         |
| TE          | 125-250-300             | 2011-2012   | OEM   | HBG Blue | R-PAKTMAH0300 | € 28,95 |
|             |                         |             |   | White    | R-PAKTMBN0300 |         |
|             |                         |             |   | Black    | R-PAKTMNR0300 |         |
| TE / FE     | 125-250-300-350-450-501 | 2013-2014   | OEM - Vented front fender<br>Vented front fender<br>Vented front fender | HBG Blue | R-PAHSQAH9914 | € 31,95 |
|             |                         |             |   | White    | R-PAHSQBN9914 |         |
|             |                         |             |   | Black    | R-PAHSQNR9914 |         |

## HUSABERG REAR FENDER / PARAFANGO POSTERIORE



R-PPHSQAH0014



R-PPHSQBN0014



R-PPHSQNR0014

### AVAILABLE COLORS

HBG Blue Black White

**OEM** original color

| MODEL   | CC                      | YEAR      | NOTES | COLOR    | CODE          | PRICE   |
|---------|-------------------------|-----------|-------|----------|---------------|---------|
| TE      | 125                     | 2011-2012 | OEM   | Black    | R-CDKTMNREXC8 | € 76,95 |
|         |                         |           |       | White    | R-CDKTMBNEXC8 |         |
| TE      | 250-300                 | 2011-2012 | OEM   | Black    | R-CDKTMNREXC8 | € 76,95 |
|         |                         |           |       | White    | R-CDKTMBNEXC8 |         |
| TE / FE | 125-250-300-350-450-501 | 2013-2014 | OEM   | HBG Blue | R-PPHSQAH0014 | € 34,95 |
|         |                         |           |       | White    | R-PPHSQBN0014 |         |
|         |                         |           |       | Black    | R-PPHSQNR0014 |         |



R-CVHSAH0014



R-CVHSQB0014



R-CVHSQR0014



## AVAILABLE COLORS

HBG Blue
  Black
  White

**OEM original color**

| MODEL   | CC                      | YEAR      | NOTES | COLOR    | CODE         | PRICE   |
|---------|-------------------------|-----------|-------|----------|--------------|---------|
| TE / FE | 125-250-300-350-450-501 | 2013-2014 | OEM   | HBG Blue | R-CVHSAH0014 | € 65,95 |
|         |                         |           |       | White    | R-CVHSQB0014 |         |
|         |                         |           |       | Black    | R-CVHSQR0014 |         |

# HUSABERG SIDE PANELS / TABELLE LATERALI PORTANUMERO



R-FIHSQB0014



## AVAILABLE COLORS

Black
  White

| MODEL   | CC                      | YEAR      | NOTES       | COLOR | CODE          | PRICE   |
|---------|-------------------------|-----------|-------------|-------|---------------|---------|
| TE      | 125                     | 2012      | OEM - right | Black | R-FIKTMNRDX07 | € 47,95 |
|         |                         |           | right       | White | R-FIKTMBNDX07 |         |
| TE      | 125                     | 2012      | OEM - left  | Black | R-FIKTMNRSX07 | € 31,95 |
|         |                         |           | left        | White | R-FIKTMBNSX07 |         |
| TE      | 250-300                 | 2011-2012 | OEM - right | Black | R-FIKTMNRDX07 | € 47,95 |
|         |                         |           | right       | White | R-FIKTMBNDX07 |         |
| TE      | 250-300                 | 2011-2012 | OEM - left  | Black | R-FIKTMNRSX07 | € 31,95 |
|         |                         |           | left        | White | R-FIKTMBNSX07 |         |
| TE / FE | 125-250-300-350-450-501 | 2013-2014 | OEM         | White | R-FIHSQB0014  | € 57,95 |
|         |                         |           |             | Black | R-FIHSQR0014  |         |

## HUSABERG FORK PROTECTORS / PARASTELI FORCELLA



### AVAILABLE COLORS

- HBG Blue
- Black
- White

R-PSKTMAH0008

R-PSKTMBN0008

R-PSKTMNR0008

**OEM** original color

| MODEL       | CC                      | YEAR        | NOTES                            | COLOR    | CODE          | PRICE   |
|-------------|-------------------------|-------------|----------------------------------|----------|---------------|---------|
| TE          | 125                     | 2012 > 2014 | OEM                              | White    | R-PSKTMBN0008 | € 34,95 |
|             |                         |             |                                  | Black    | R-PSKTMNR0008 |         |
|             |                         |             |                                  | HBG Blue | R-PSKTMAH0008 |         |
| TE          | 250-300                 | 2011 > 2014 | OEM                              | White    | R-PSKTMBN0008 | € 34,95 |
|             |                         |             |                                  | Black    | R-PSKTMNR0008 |         |
|             |                         |             |                                  | HBG Blue | R-PSKTMAH0008 |         |
| FE/FS/FC/FX | 250-350-400-450-501-650 | 2009 > 2014 | OEM 2011 > 2014<br>OEM 2009-2010 | White    | R-PSKTMBN0008 | € 34,95 |
|             |                         |             |                                  | Black    | R-PSKTMNR0008 |         |
|             |                         |             |                                  | HBG Blue | R-PSKTMAH0008 |         |

## HUSABERG REAR SHOCK MUD FLAP / PARASPRUZZI MONOAMMORTIZZATORE



R-PSPKTMNR007

### AVAILABLE COLORS

- Black

**OEM** original color

| MODEL | CC              | YEAR        | NOTES | COLOR | CODE          | PRICE   |
|-------|-----------------|-------------|-------|-------|---------------|---------|
| TE    | 125-250-300     | 2011 > 2014 |       | Black | R-PSPKTMNR007 | € 14,95 |
| FE    | 250-350-450-501 | 2013-2014   |       | Black | R-PSPKTMNR007 | € 14,95 |

## HUSABERG CHAIN GUIDE / CRUNA GUIDA CATENA



R-CRUKTMNRAH7



R-CRUKTMNRR7

### AVAILABLE COLORS

- Black-Neutral
- Black-HBG Blue

**OEM** original color

| MODEL        | CC                  | YEAR        | NOTES                            | COLOR           | CODE          | PRICE   |
|--------------|---------------------|-------------|----------------------------------|-----------------|---------------|---------|
| FE / FS / FX | 350-400-450-500-650 | 2009 > 2014 | OEM - Bi-Material<br>Bi-Material | Black-Neutral   | R-CRUKTMNRR7  | € 38,95 |
|              |                     |             |                                  | Black-HBG Blue  | R-CRUKTMNRAH7 |         |
| TE           | 125                 | 2012 > 2014 | OEM - Bi-Material<br>Bi-Material | Black-Neutral   | R-CRUKTMNRR7  | € 38,95 |
|              |                     |             |                                  | Black- HBG Blue | R-CRUKTMNRAH7 |         |
| TE           | 250-300             | 2011 > 2014 | OEM - Bi-Material<br>Bi-Material | Black-Neutral   | R-CRUKTMNRR7  | € 38,95 |
|              |                     |             |                                  | Black- HBG Blue | R-CRUKTMNRAH7 |         |



MONOBLOCK R2.0 WORX CHAIN GUIDE - PAG. 254



## AVAILABLE COLORS

HBG Blue
  Black
  White

| MOD                              | CC                      | YEAR      | NOTES    | COLOR | CODE | PRICE                            |
|----------------------------------|-------------------------|-----------|----------|-------|------|----------------------------------|
| TE / FE                          | 125-250-300-350-450-501 | 2013-2014 | OEM 2014 | OEM   |      | <b>R-KITHBG-OEM-400</b> € 124,95 |
| kit includes vented front fender |                         |           |          | White |      | <b>R-KITHBG-BN0-400</b>          |
|                                  |                         |           |          | Black |      | <b>R-KITHBG-NR0-400</b>          |

## HUSABERG CHAIN SLIDER / SLITTA SCORRICATENA FORCELLONE



R-SLIKTMAH007

## AVAILABLE COLORS

HBG Blue
  Black

| MODEL        | CC                      | YEAR        | NOTES | COLOR    | CODE                 | PRICE   |
|--------------|-------------------------|-------------|-------|----------|----------------------|---------|
| FE / FS / FX | All models              | 2009 > 2012 | OEM   | Black    | <b>R-SLIKTMR007</b>  | € 25,95 |
|              |                         |             |       | HBG Blue | <b>R-SLIKTMAH007</b> |         |
| TE           | 250-300                 | 2011-2012   | OEM   | Black    | <b>R-SLIKTMR007</b>  | € 25,95 |
|              |                         |             |       | HBG Blue | <b>R-SLIKTMAH007</b> |         |
| TE / FE      | 125-250-300-350-450-501 | 2013-2014   | OEM   | Black    | <b>R-SLIKTMR012</b>  | € 25,95 |
|              |                         |             |       | HBG Blue | <b>R-SLIKTMAH012</b> |         |

## AVAILABLE COLORS

Black

| MODEL        | CC                  | YEAR        | NOTES | COLOR | CODE                | PRICE  |
|--------------|---------------------|-------------|-------|-------|---------------------|--------|
| FE / FS / FX | 350-400-450-500-650 | 2009 > 2012 | OEM   | Black | <b>R-PATTKTMR01</b> | € 9,95 |
| TE           | 250-300             | 2011-2012   | OEM   | Black | <b>R-PATTKTMR01</b> | € 9,95 |
| TE / FE      | 125-250-350-450-501 | 2013-2014   | OEM   | Black | <b>R-PATTKTMR11</b> | € 9,95 |

## HUSABERG CHAIN PAD / PATTINO SCORRICATENA





## HUSQVARNA

**Vented front fender / Parafango anteriore >pag 196**

**Rear fender / Parafango posteriore >pag 198**

**Radiator shrouds / Convogliatori aria radiatore >pag 200**

**Side panels / Tabelle laterali portanumero >pag 203**

**Air box covers / Coperchi laterali cassa filtro >pag 205**

**Fork protectors / Parasteli forcella >pag 207**

**Front number plate / Tabella portanumero anteriore >pag 209**

**Front headlight / Mascherina portafaro >pag 211**

**Oversize radiator louvers / Griglie radiatore maggiorate >pag 212**

**Front fender brace / Rinforzo parafango anteriore >pag 214**

**Rear shock mud flap / Paraspruzzi monoammortizzatore >pag 214**

**Chain slider / Slitta scorricatena forcellone >pag 214**

**Chain pad / Pattino scorricatena >pag 215**

**Chain guide / Cruna guida catena >pag 215**

**Replica plastics kit / Kit plastiche replica >pag 216**

# HUSQVARNA VENTED FRONT FENDER / PARAFANGO ANTERIORE VENTILATO

ALL FENDERS ON THIS PAGE ARE VENTED AIRFLOW MODELS / PARAFANGO CON PRE-TAGLIO PER LA VENTILAZIONE

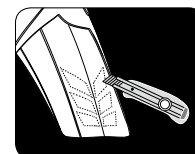

## AVAILABLE COLORS

- HSQ Yellow
- Quantum Grey
- Black
- Neon Yellow
- White
- Neon Pink

**OEM** original color - ☀️ fluorescent color

| MODEL   | CC                      | YEAR        | NOTES           | COLOR       |  | CODE          | PRICE   |
|---------|-------------------------|-------------|-----------------|-------------|--|---------------|---------|
| TC      | 65                      | 2017 > 2023 | OEM             | White       |  | R-PAHSQBN0065 | € 29,95 |
|         |                         |             |                 | Black       |  | R-PAHSQNR0065 |         |
|         |                         |             |                 | Neon Yellow |  | R-PAHSQGF0065 |         |
| TC      | 85                      | 2014 > 2017 | OEM             | White       |  | R-PAHSQBN0085 | € 29,95 |
|         |                         |             |                 | Black       |  | R-PAHSQNR0085 |         |
| TC      | 85                      | 2018 > 2023 | OEM             | White       |  | R-PAHSQBN0185 | € 32,95 |
|         |                         |             |                 | Black       |  | R-PAHSQNR0185 |         |
|         |                         |             |                 | Neon Yellow |  | R-PAHSQGF0185 |         |
| CR / WR | 125-250-300             | 2006 > 2013 | OEM 2007 > 2013 | White       |  | R-PAHSQBN0005 | € 31,95 |
|         |                         |             |                 | Black       |  | R-PAHSQNR0005 |         |
| TC / TE | 250-310                 | 2005 > 2013 | OEM 2007 > 2013 | White       |  | R-PAHSQBN0005 | € 31,95 |
|         |                         |             |                 | Black       |  | R-PAHSQNR0005 |         |
| TC / TE | 450-510                 | 2005 > 2010 | OEM 2007 > 2010 | White       |  | R-PAHSQBN0005 | € 31,95 |
|         |                         |             |                 | Black       |  | R-PAHSQNR0005 |         |
| TC / TE | 449-511                 | 2011 > 2013 | OEM Bi-Color    | White-Black |  | R-PAHSQBN0011 | € 39,95 |
| TE / FE | 125-250-300-350-450-501 | 2014        | OEM             | White       |  | R-PAHSQBN9914 | € 31,95 |
|         |                         |             |                 | Black       |  | R-PAHSQNR9914 |         |



# HUSQVARNA VENTED FRONT FENDER / PARAFANGO ANTERIORE VENTILATO

ALL FENDERS ON THIS PAGE ARE VENTED AIRFLOW MODELS / PARAFANGO CON PRE-TAGLIO PER LA VENTILAZIONE

 NEON



R-PAHSQFU9916

 NEON





R-PAHSQGF9916









































R-PAHSQGR9916

## AVAILABLE COLORS

|  |  |
|--|--|
|  HSQ Yellow |  Quantum Grey |
|  Black      |  Neon Yellow  |
|  White      |  Neon Pink    |

**OEM** original color -  fluorescent color

| MODEL        | CC                      | YEAR        | NOTES                                | COLOR        |   | CODE          | PRICE   |
|--------------|-------------------------|-------------|--------------------------------------|--------------|---|---------------|---------|
| TE / FE      | 125-250-300-350-450-501 | 2014        | OEM - Vented front fender            | White        |    | R-PAHSQBN9914 | € 31,95 |
|              |                         |             | Vented front fender                  | Black        |    | R-PAHSQNR9914 |         |
| TC           | 125                     | 2014-2015   | OEM - Vented front fender            | White        |    | R-PAHSQBN9915 | € 31,95 |
|              |                         |             | Vented front fender                  | Black        |    | R-PAHSQNR9915 |         |
| TC - TX      | 125-150                 | 2016 > 2022 | OEM - Vented front fender            | White        |    | R-PAHSQBN9916 | € 36,95 |
|              |                         |             | OEM 2020>2022 - Vented front fender  | White 2020   |    | R-PAHSQBN9920 |         |
|              |                         |             | Vented front fender                  | Black        |    | R-PAHSQNR9916 |         |
|              |                         |             | Vented front fender                  | Neon Yellow  |   | R-PAHSQGF9916 |         |
|              |                         |             | Vented front fender -Limited Edition | Neon Pink    |  | R-PAHSQFU9916 |         |
|              |                         |             | Vented front fender -Limited Edition | Quantum Grey |  | R-PAHSQGR9916 |         |
| TC           | 250                     | 2014 > 2016 | OEM - Vented front fender            | White        |  | R-PAHSQBN9915 | € 31,95 |
|              |                         |             | Vented front fender                  | Black        |  | R-PAHSQNR9915 |         |
| TC / TX      | 250-300                 | 2017 > 2022 | OEM - Vented front fender            | White        |  | R-PAHSQBN9916 | € 36,95 |
|              |                         |             | OEM 2020>2022 - Vented front fender  | White 2020   |  | R-PAHSQBN9920 |         |
|              |                         |             | Vented front fender                  | Black        |  | R-PAHSQNR9916 |         |
|              |                         |             | Vented front fender                  | Neon Yellow  |  | R-PAHSQGF9916 |         |
|              |                         |             | Vented front fender -Limited Edition | Neon Pink    |  | R-PAHSQFU9916 |         |
|              |                         |             | Vented front fender -Limited Edition | Quantum Grey |  | R-PAHSQGR9916 |         |
| TE / FE      | 125-250-300-350-450-501 | 2015-2016   | OEM - Vented front fender            | White        |  | R-PAHSQBN9915 | € 31,95 |
|              |                         |             | Vented front fender                  | Black        |  | R-PAHSQNR9915 |         |
| FC           | 250-350-450             | 2014-2015   | OEM - Vented front fender            | White        |  | R-PAHSQBN9915 | € 31,95 |
|              |                         |             | Vented front fender                  | Black        |  | R-PAHSQNR9915 |         |
| TE / FE / FX | 150-250-300-350-450-501 | 2017 > 2023 | OEM - Vented front fender            | White        |  | R-PAHSQBN9916 | € 36,95 |
|              |                         |             | OEM 2020>2023 - Vented front fender  | White 2020   |  | R-PAHSQBN9920 |         |
|              |                         |             | Vented front fender                  | Black        |  | R-PAHSQNR9916 |         |
|              |                         |             | Vented front fender                  | Neon Yellow  |  | R-PAHSQGF9916 |         |
|              |                         |             | Vented front fender -Limited Edition | Neon Pink    |  | R-PAHSQFU9916 |         |
|              |                         |             | Vented front fender -Limited Edition | Quantum Grey |  | R-PAHSQGR9916 |         |
| FC           | 250-350-450             | 2016 > 2022 | OEM - Vented front fender            | White        |  | R-PAHSQBN9916 | € 36,95 |
|              |                         |             | OEM 2020>2022 - Vented front fender  | White 2020   |  | R-PAHSQBN9920 |         |
|              |                         |             | Vented front fender                  | Black        |  | R-PAHSQNR9916 |         |
|              |                         |             | Vented front fender                  | Neon Yellow  |  | R-PAHSQGF9916 |         |
|              |                         |             | Vented front fender                  | Neon Pink    |  | R-PAHSQFU9916 |         |
|              |                         |             | Limited Edition                      | Quantum Grey |  | R-PAHSQGR9916 |         |
| FC           | 450 ROCKSTAR EDITION    | 2018 > 2021 | OEM - Vented front fender            | White        |  | R-PAHSQBN9916 | € 36,95 |
|              |                         |             | OEM 2020-2021 - Vented front fender  | White 2020   |  | R-PAHSQBN9920 |         |
|              |                         |             | Vented front fender                  | Black        |  | R-PAHSQNR9916 |         |
|              |                         |             | Vented front fender                  | Neon Yellow  |  | R-PAHSQGF9916 |         |
|              |                         |             | Vented front fender                  | Neon Pink    |  | R-PAHSQFU9916 |         |
|              |                         |             | Limited Edition                      | Quantum Grey |  | R-PAHSQGR9916 |         |

# HUSQVARNA REAR FENDER / PARAFANGO POSTERIORE



R-PPHSQBN0020



R-PPHSQGF0020

NEON

## AVAILABLE COLORS



**OEM** original color - fluorescent color

| MODEL   | CC                      | YEAR            | NOTES           | COLOR        |               | CODE          | PRICE   |
|---------|-------------------------|-----------------|-----------------|--------------|---------------|---------------|---------|
| TC      | 65                      | 2017 > 2023     | OEM 2017 > 2022 | White        |               | R-PPHSQBN0065 | € 29,95 |
|         |                         |                 |                 | Black        |               | R-PPHSQNR0065 |         |
|         |                         |                 | OEM 2023        | HSQ Yellow   |               | R-PPHSQGF0065 |         |
|         |                         |                 | Neon Yellow     |              | R-PPHSQGF0065 |               |         |
| TC      | 85                      | 2014 > 2017     | OEM             | White        |               | R-PPKTMBN0985 | € 29,95 |
|         |                         |                 |                 | Black        |               | R-PPKTMBN0985 |         |
|         |                         |                 |                 | Neon Yellow  |               | R-PPKTMBN0985 |         |
| TC      | 85                      | 2018 > 2023     | OEM 2018 > 2022 | White        |               | R-PPHSQBN0185 | € 32,95 |
|         |                         |                 |                 | Black        |               | R-PPHSQNR0185 |         |
|         |                         |                 | OEM 2023        | Neon Yellow  |               | R-PPHSQGF0185 |         |
|         |                         |                 | Neon Yellow     |              | R-PPHSQGF0185 |               |         |
| CR / WR | 125                     | 2006 > 2008     | OEM 2007-2008   | White        |               | R-PPHSQBN0005 | € 34,95 |
| CR / WR | 125                     | 2009 > 2013     | OEM             | White        |               | R-PPHSQBN0009 | € 36,95 |
|         |                         |                 |                 | Black        |               | R-PPHSQNR0009 |         |
| CR / WR | 250-300                 | 2006 > 2013     | OEM 2007 > 2013 | White        |               | R-PPHSQBN0005 | € 34,95 |
| TC / TE | 250-310-450-510         | 2005 > 2007     | OEM 2007        | White        |               | R-PPHSQBN0005 | € 34,95 |
| TC / TE | 250-310                 | 2008 > 2013     | OEM             | White        |               | R-PPHSQBN0008 | € 34,95 |
|         |                         |                 |                 | Black        |               | R-PPHSQNR0008 |         |
| TC / TE | 450-510                 | 2008 > 2010     | OEM             | White        |               | R-PPHSQBN0008 | € 34,95 |
|         |                         |                 |                 | Black        |               | R-PPHSQNR0008 |         |
| TC / TE | 449-511                 | 2011 > 2013     | OEM             | White        |               | R-PPHSQLATBN1 | € 40,95 |
| TC / TE | 449-511                 | 2011 > 2013     | OEM no LED      | White        |               | R-PPHSQBN0011 | € 27,95 |
|         |                         |                 | no LED          | Black        |               | R-PPHSQNR0011 |         |
| TE / FE | 125-250-300-350-450-501 | 2014 > 2016     | OEM             | White        |               | R-PPHSQBN0014 | € 34,95 |
|         |                         |                 |                 | Black        |               | R-PPHSQNR0014 |         |
| TE / FE | 150-250-300-350-450-501 | 2017 > 2019     | OEM             | White        |               | R-PPHSQBN0017 | € 36,95 |
|         |                         |                 |                 | Black        |               | R-PPHSQNR0017 |         |
|         |                         |                 |                 | Neon Yellow  |               | R-PPHSQGF0017 |         |
|         |                         |                 |                 | HSQ Blue     |               | R-PPHSQBLH017 |         |
|         |                         |                 | Limited Edition | Quantum Grey |               | R-PPHSQGR0017 |         |
| TE / FE | 150-250-300-350-450-501 | 2020 > 2023     | OEM 2020 > 2022 | White        |               | R-PPHSQBN0020 | € 36,95 |
|         |                         |                 |                 | Black        |               | R-PPHSQNR0020 |         |
|         |                         |                 |                 | Neon Yellow  |               | R-PPHSQGF0020 |         |
|         |                         |                 |                 | Quantum Grey |               | R-PPHSQGR0020 |         |
|         |                         |                 |                 | HSQ yellow   |               | R-PPHSQGF0020 |         |
|         |                         |                 |                 | White        |               | R-PPHSQBNOC14 |         |
|         |                         |                 |                 | Black        |               | R-PPHSQNR0C14 |         |
| TC      | 125                     | 2014-2015       | OEM             | White        |               | R-PPHSQBNOC16 | € 36,95 |
|         |                         |                 |                 | HSQ Blue     |               | R-PPHSQBLHC16 |         |
|         |                         |                 |                 | Black        |               | R-PPHSQNR0C16 |         |
|         |                         |                 |                 | Neon Yellow  |               | R-PPHSQGF0C16 |         |
|         |                         |                 | Quantum Grey    |              | R-PPHSQGR0C16 |               |         |
| TC / FC | 125-250-350-450         | 2019 > 2022     | OEM             | White        |               | R-PPHSQBN0019 | € 32,95 |
|         |                         |                 |                 | Black        |               | R-PPHSQNR0019 |         |
|         |                         |                 |                 | Neon Yellow  |               | R-PPHSQGF0019 |         |
|         |                         |                 |                 | Quantum Grey |               | R-PPHSQGR0019 |         |
|         |                         |                 |                 | HSQ yellow   |               | R-PPHSQGF0019 |         |
| TX      | 125-150                 | 2017 > 2019     | OEM             | White        |               | R-PPHSQBN0017 | € 36,95 |
|         |                         |                 |                 | Black        |               | R-PPHSQNR0017 |         |
|         |                         |                 |                 | Neon Yellow  |               | R-PPHSQGF0017 |         |
|         |                         |                 |                 | HSQ Blue     |               | R-PPHSQBLH017 |         |
|         |                         |                 |                 | Quantum Grey |               | R-PPHSQGR0017 |         |
| TC      | 250                     | 2014 > 2016     | OEM             | White        |               | R-PPHSQBNOC14 | € 34,95 |
|         |                         |                 |                 | Black        |               | R-PPHSQNR0C14 |         |
| TC / TX | 250-300                 | 2017-2018       | OEM 2017-2018   | White        |               | R-PPHSQBNOC16 | € 36,95 |
|         |                         |                 |                 | HSQ Blue     |               | R-PPHSQBLHC16 |         |
|         |                         |                 |                 | Black        |               | R-PPHSQNR0C16 |         |
|         |                         |                 |                 | Neon Yellow  |               | R-PPHSQGF0C16 |         |
|         |                         |                 |                 | Quantum Grey |               | R-PPHSQGR0C16 |         |
|         |                         | Limited Edition |                 |              |               |               |         |

# HUSQVARNA REAR FENDER / PARAFANGO POSTERIORE



































R-PPHSQGR0020



R-PPHSQNR0020

**OEM** original color -  fluorescent color

| MODEL   | CC                   | YEAR        | NOTES                              | COLOR        |   | CODE          | PRICE   |
|---------|----------------------|-------------|------------------------------------|--------------|---|---------------|---------|
| FX      | 350-450              | 2017-2018   | OEM                                | White        |    | R-PPHSQBN0C16 | € 36,95 |
|         |                      |             |                                    | HSQ Blue     |    | R-PPHSQBLHC16 |         |
|         |                      |             |                                    | Black        |    | R-PPHSQNR0C16 |         |
|         |                      |             |                                    | Neon Yellow  |    | R-PPHSQGF0C16 |         |
|         |                      |             |                                    | Quantum Grey |    | R-PPHSQGR0C16 |         |
| TX / FX | 300-350-450          | 2019 > 2022 | OEM                                | White        |    | R-PPHSQBN0019 | € 32,95 |
|         |                      |             |                                    | Black        |    | R-PPHSQNR0019 |         |
|         |                      |             |                                    | Neon Yellow  |    | R-PPHSQGF0019 |         |
|         |                      |             |                                    | Quantum Grey |    | R-PPHSQGR0019 |         |
|         |                      |             |                                    | HSQ yellow   |    | R-PPHSQGG0019 |         |
| FC      | 250-350-450          | 2014-2015   | OEM                                | White        |    | R-PPHSQBN0C14 | € 34,95 |
|         |                      |             |                                    | Black        |    | R-PPHSQNR0C14 |         |
| FC      | 250-350-450          | 2016 > 2018 | OEM 2017-2018<br>OEM 2016          | White        |    | R-PPHSQBN0C16 | € 36,95 |
|         |                      |             |                                    | HSQ Blue     |  | R-PPHSQBLHC16 |         |
|         |                      |             |                                    | Black        |  | R-PPHSQNR0C16 |         |
|         |                      |             |                                    | Neon Yellow  |  | R-PPHSQGF0C16 |         |
|         |                      |             |                                    | Quantum Grey |  | R-PPHSQGR0C16 |         |
| FC      | 450 Rockstar Edition | 2018 > 2021 | Limited Edition<br>OEM 2018 > 2020 | White        |  | R-PPHSQBN0019 | € 32,95 |
|         |                      |             |                                    | Black        |  | R-PPHSQNR0019 |         |
|         |                      |             |                                    | Neon Yellow  |  | R-PPHSQGF0019 |         |
|         |                      |             |                                    | Quantum Grey |  | R-PPHSQGR0019 |         |
|         |                      |             |                                    | HSQ yellow   |  | R-PPHSQGG0019 |         |
| FS      | 450                  | 2017-2018   | OEM                                | White        |  | R-PPHSQBN0C16 | € 36,95 |
|         |                      |             |                                    | HSQ Blue     |  | R-PPHSQBLHC16 |         |
|         |                      |             |                                    | Black        |  | R-PPHSQNR0C16 |         |
|         |                      |             |                                    | Neon Yellow  |  | R-PPHSQGF0C16 |         |
|         |                      |             |                                    | Quantum Grey |  | R-PPHSQGR0C16 |         |
| FS      | 450                  | 2019 > 2022 | OEM                                | White        |  | R-PPHSQBN0019 | € 32,95 |
|         |                      |             |                                    | Black        |  | R-PPHSQNR0019 |         |
|         |                      |             |                                    | Neon Yellow  |  | R-PPHSQGF0019 |         |
|         |                      |             |                                    | Quantum Grey |  | R-PPHSQGR0019 |         |
|         |                      |             |                                    | HSQ yellow   |  | R-PPHSQGG0019 |         |

# HUSQVARNA RADIATOR SHROUDS / CONVOGLIATORI ARIA RADIATORE



NEON



## AVAILABLE COLORS

















OEM original color - ☀️ fluorescent color

| MODEL      | CC              | YEAR        | NOTES   | COLOR               | CODE           | PRICE         |         |
|------------|-----------------|-------------|---|---------------------|----------------|---------------|---------|
| TC         | 65              | 2017 > 2023 | OEM 2017 > 2022   | White               | R-CVHSQBN0065  | € 54,95       |         |
|            |                 |             |   | Black               | R-CVHSQNR0065  |               |         |
|            |                 |             |   | Neon Yellow         | R-CVHSQGF0065  |               |         |
|            |                 |             |   | Grey                | R-CVHSQGRH0065 |               |         |
|            |                 |             |   |                     |                |               |         |
| TC         | 85              | 2014 > 2017 | OEM 2023<br>OEM 2016<br>OEM 2014-2015 and 2017                | HSQ Blue            | R-CVHSQBLH085  | € 57,95       |         |
|            |                 |             |   | White               | R-CVHSQBN0085  |               |         |
|            |                 |             |   | Black               | R-CVHSQNR0085  |               |         |
|            |                 |             |   | White               | R-CVHSQBN0185  |               |         |
|            |                 |             |   | Neon Yellow         | R-CVHSQGF0185  |               |         |
| TC         | 85              | 2018 > 2023 | OEM 2017 > 2022   | White               | R-CVHSQBN0185  | € 54,95       |         |
|            |                 |             |   | Black               | R-CVHSQNR0185  |               |         |
|            |                 |             |   | Neon Yellow         | R-CVHSQGF0185  |               |         |
|            |                 |             |   | Grey                | R-CVHSQGRH185  |               |         |
|            |                 |             |   |                     |                |               |         |
| CR / WR    | 125             | 2005 > 2007 | Lower   | Black               | R-CVHSQNRLO06  | € 22,95       |         |
| CR / WR    | 125-250         | 2005        | Upper   | HSQ Red             | R-CVHSQRQUP05  | € 54,95       |         |
| CR / WR    | 125             | 2006 > 2008 | OEM - Upper   | Upper               | HSQ Red        | R-CVHSQRQUP08 | € 54,95 |
|            |                 |             |   | Upper               | White          | R-CVHSQBNUP08 |         |
|            |                 |             |   | Upper               | Black          | R-CVHSQNRUP08 |         |
| CR / WR    | 125             | 2009 > 2013 | Lower   | Black               | R-CVHSQNRLO09  | € 22,95       |         |
| CR / WR    | 125             | 2009 > 2013 | OEM - Upper   | Upper               | HSQ Red        | R-CVHSQRQUP09 | € 54,95 |
|            |                 |             |   | Upper               | Black          | R-CVHSQNRUP09 |         |
| CR / WR    | 250-300         | 2006 > 2013 | Lower   | Black               | R-CVHSQNRLO06  | € 22,95       |         |
| CR / WR    | 250-300         | 2006 > 2013 | OEM 2007 > 2013 - Upper                                       | HSQ Red             | R-CVHSQRQUP05  | € 54,95       |         |
| TC / TE    | 250-310-450-510 | 2005 > 2007 | OEM 2007 - Lower  | Black               | R-CVHSQNRLO05  | € 22,95       |         |
| TC / TE    | 250-310-450-510 | 2005 > 2007 | OEM 2007 - Upper  | HSQ Red             | R-CVHSQRQUP05  | € 54,95       |         |
| TC         | 250             | 2008        | Lower   | Black               | R-CVHSQNRLO08  | € 22,95       |         |
| TC         | 250             | 2008        | OEM - Upper   | Upper               | HSQ Red        | R-CVHSQRQUP08 | € 54,95 |
|            |                 |             |   | Upper               | White          | R-CVHSQBNUP08 |         |
|            |                 |             |   | Upper               | Black          | R-CVHSQNRUP08 |         |
| TC / TE    | 310-450-510     | 2008 > 2010 | OEM - Lower   | Black               | R-CVHSQNRLO08  | € 22,95       |         |
| TC / TE    | 450-510         | 2008 > 2010 | OEM - Upper   | Upper               | HSQ Red        | R-CVHSQRQUP08 | € 54,95 |
|            |                 |             |   | Upper               | White          | R-CVHSQBNUP08 |         |
|            |                 |             |   | Upper               | Black          | R-CVHSQNRUP08 |         |
| TC         | 250             | 2009 > 2013 | Lower   | Black               | R-CVHSQNRLO09  | € 22,95       |         |
| TC         | 250             | 2009 > 2013 | OEM - Upper   | Upper               | HSQ Red        | R-CVHSQRQUP09 | € 54,95 |
|            |                 |             |   | Upper               | Black          | R-CVHSQNRUP09 |         |
| TE         | 250             | 2008-2009   | Lower   | Black               | R-CVHSQNRLO08  | € 22,95       |         |
| TE         | 250             | 2008-2009   | OEM - Upper   | Upper               | HSQ Red        | R-CVHSQRQUP08 | € 54,95 |
|            |                 |             |   | Upper               | White          | R-CVHSQBNUP08 |         |
|            |                 |             |   | Upper               | Black          | R-CVHSQNRUP08 |         |
| TE         | 250             | 2010 > 2013 | Lower   | Black               | R-CVHSQNRLO09  | € 22,95       |         |
| TE         | 250             | 2010 > 2013 | OEM - Upper   | Upper               | HSQ Red        | R-CVHSQRQUP09 | € 54,95 |
|            |                 |             |   | Upper               | Black          | R-CVHSQNRUP09 |         |
|            |                 |             |   | Upper               | HSQ Red        | R-CVHSQRQUP08 | € 54,95 |
| TE         | 310             | 2008 > 2010 | Upper   | Upper               | White          | R-CVHSQBNUP08 |         |
|            |                 |             |   | Upper               | Black          | R-CVHSQNRUP08 |         |
|            |                 |             |   | Upper               | Black          | R-CVHSQNRLO09 | € 22,95 |
| TE         | 310             | 2012-2013   | Lower   | Black               | R-CVHSQNRLO09  | € 22,95       |         |
| TE         | 310             | 2012        | OEM - Upper   | Upper               | HSQ Red        | R-CVHSQRQUP09 | € 54,95 |
|            |                 |             |   | Upper               | Black          | R-CVHSQNRUP09 |         |
|            |                 |             |   | Upper               | Black          | R-CVHSQNRLO08 | € 22,95 |
| SMR / SMRR | 310-450-510     | 2008 > 2010 | OEM - Lower   | Black               | R-CVHSQNRLO08  | € 22,95       |         |
| SMR / SMRR | 450-510         | 2008 > 2010 | OEM - Upper   | Upper               | HSQ Red        | R-CVHSQRQUP08 | € 54,95 |
|            |                 |             |   | Upper               | White          | R-CVHSQBNUP08 |         |
|            |                 |             |   | Upper               | Black          | R-CVHSQNRUP08 |         |
| TC / TE    | 449-511         | 2011 > 2013 | OEM   | Black               | R-CVHSQNR0011  | € 43,95       |         |
| TC         | 125             | 2014-2015   | 2016 - Bi-Color<br>OEM 2014 - Bi-Color<br>OEM 2015 - Bi-Color | HSQ Blue-HSQ Yellow | R-CVHSQBLHGQ14 | € 65,95       |         |
|            |                 |             |   | White-Black         | R-CVHSQBN0014  |               |         |
|            |                 |             |   | White-HSQ Yellow    | R-CVHSQBNGQ14  |               |         |
|            |                 |             |   | Black               | R-CVHSQNR0014  |               |         |

# HUSQVARNA RADIATOR SHROUDS / CONVOGLIATORI ARIA RADIATORE

**OEM** original color -  fluorescent color

| MODEL          | CC                      | YEAR        | NOTES   | COLOR               | CODE   | PRICE   |
|----------------|-------------------------|-------------|---|---------------------|--|---------|
| <b>TC</b>      | 125                     | 2016 > 2018 | OEM 2016<br>OEM 2017-2018   | HSQ Blue            |  R-CVHSQBLH016    | € 57,95 |
|                |                         |             |   | White               |  R-CVHSQBN0016    |         |
|                |                         |             |   | Black               |  R-CVHSQNR0016    |         |
|                |                         |             |   | Neon Yellow         |  R-CVHSQGF0016    |         |
|                |                         |             |   | Neon Pink           |  R-CVHSQFU0016    |         |
|                |                         |             |   | HSQ Red             |  R-CVHSQRQ0016    |         |
|                |                         |             |   | Quantum Grey        |  R-CVHSQGR0016    |         |
| <b>TX</b>      | 125-150                 | 2017 > 2019 | Limited Edition<br>OEM 2019<br>OEM 2017-2018                      | White               |  R-CVHSQBN0016    | € 57,95 |
|                |                         |             |   | HSQ Blue            |  R-CVHSQBLH016    |         |
|                |                         |             |   | Black               |  R-CVHSQNR0016    |         |
|                |                         |             |   | Neon Yellow         |  R-CVHSQGF0016    |         |
|                |                         |             |   | Neon Pink           |  R-CVHSQFU0016    |         |
|                |                         |             |   | HSQ Red             |  R-CVHSQRQ0016    |         |
|                |                         |             |   | Quantum Grey        |  R-CVHSQGR0016    |         |
| <b>TC / TX</b> | 250-300                 | 2017-2018   | Limited Edition<br>OEM  | White               |  R-CVHSQBN0016    | € 57,95 |
|                |                         |             |   | HSQ Blue            |  R-CVHSQBLH016    |         |
|                |                         |             |   | Black               |  R-CVHSQNR0016    |         |
|                |                         |             |   | Neon Yellow         |  R-CVHSQGF0016    |         |
|                |                         |             |   | Neon Pink           |  R-CVHSQFU0016    |         |
|                |                         |             |   | HSQ Red             |  R-CVHSQRQ0016    |         |
|                |                         |             |   | Quantum Grey        |  R-CVHSQGR0016    |         |
| <b>TX-FX</b>   | 300-350-450             | 2019 > 2022 | Limited Edition<br>OEM  | White               |  R-CVHSQBN0019    | € 54,95 |
|                |                         |             |   | Black               |  R-CVHSQNR0019    |         |
|                |                         |             |   | Neon Yellow         |  R-CVHSQGF0019    |         |
|                |                         |             |   | Quantum Grey        |  R-CVHSQGR0019   |         |
| <b>TX-FX</b>   | 300-350-450             | 2023        | OEM   | Grey                |  R-CVHSQGRH023   | € 43,95 |
|                |                         |             |   | Black               |  R-CVHSQNR0023  |         |
|                |                         |             |   | White               |  R-CVHSQBN0023  |         |
|                |                         |             |   | HSQ Yellow          |  R-CVHSQGG0023  |         |
|                |                         |             |   | Quantum Grey        |  R-CVHSQGR0023  |         |
|                |                         |             |   | HSQ Blue-HSQ Yellow |  R-CVHSQBLHGQ14 |         |
| <b>TC</b>      | 250                     | 2014 > 2016 | OEM 2016 - Bi-Color<br>OEM 2015 - Bi-Color<br>OEM 2014 - Bi-Color | White-HSQ Yellow    |  R-CVHSQBNGQ14  | € 65,95 |
|                |                         |             |   | White-Black         |  R-CVHSQBN0014  |         |
|                |                         |             |   | Black               |  R-CVHSQNR0014  |         |
|                |                         |             |   | White               |  R-CVHSQBN0019  |         |
| <b>TC-FC</b>   | 125-250-350-450         | 2019 > 2022 | OEM   | Black               |  R-CVHSQNR0019  | € 54,95 |
|                |                         |             |   | Neon Yellow         |  R-CVHSQGF0019  |         |
|                |                         |             |   | Quantum Grey        |  R-CVHSQGR0019  |         |
| <b>TC-FC</b>   | 125-250-300-350-450     | 2023        | Limited Edition<br>OEM  | Grey                |  R-CVHSQGRH023  | € 43,95 |
|                |                         |             |   | Black               |  R-CVHSQNR0023  |         |
|                |                         |             |   | White               |  R-CVHSQBN0023  |         |
|                |                         |             |   | HSQ Yellow          |  R-CVHSQGG0023  |         |
|                |                         |             |   | Quantum Grey        |  R-CVHSQGR0023  |         |
|                |                         |             |   | HSQ Blue-HSQ Yellow |  R-CVHSQBLHGQ14 |         |
| <b>TE / FE</b> | 125-250-300-350-450-501 | 2014 > 2016 | OEM 2016 - Bi-Color<br>OEM 2015 - Bi-Color<br>OEM 2014 - Bi-Color | White-HSQ Yellow    |  R-CVHSQBNGQ14  | € 65,95 |
|                |                         |             |   | White-Black         |  R-CVHSQBN0014  |         |
|                |                         |             |   | Black               |  R-CVHSQNR0014  |         |
|                |                         |             |   | White               |  R-CVHSQBN0016  |         |
| <b>TE / FE</b> | 125-250-300-350-450-501 | 2017 > 2019 | OEM 2019<br>OEM 2017-2018   | HSQ Blue            |  R-CVHSQBLH016  | € 57,95 |
|                |                         |             |   | Black               |  R-CVHSQNR0016  |         |
|                |                         |             |   | Neon Yellow         |  R-CVHSQGF0016  |         |
|                |                         |             |   | Neon Pink           |  R-CVHSQFU0016  |         |
|                |                         |             |   | HSQ Red             |  R-CVHSQRQ0016  |         |
|                |                         |             |   | Quantum Grey        |  R-CVHSQGR0016  |         |
|                |                         |             |   | White               |  R-CVHSQBN0019  |         |
| <b>TE / FE</b> | 150-250-300-350-450-501 | 2020 > 2023 | Limited Edition<br>OEM  | Black               |  R-CVHSQNR0019  | € 54,95 |
|                |                         |             |   | Neon Yellow         |  R-CVHSQGF0019  |         |
|                |                         |             |   | Quantum Grey        |  R-CVHSQGR0019  |         |
|                |                         |             |   | HSQ Blue-HSQ Yellow |  R-CVHSQBLHGQ14 |         |
| <b>FC</b>      | 250-350-450             | 2014-2015   | OEM 2016 - Bi-Color<br>OEM 2015 - Bi-Color<br>OEM 2014 - Bi-Color | White-HSQ Yellow    |  R-CVHSQBNGQ14  | € 65,95 |
|                |                         |             |   | White-Black         |  R-CVHSQBN0014  |         |
|                |                         |             |   | Black               |  R-CVHSQNR0014  |         |
|                |                         |             |   | HSQ Blue            |  R-CVHSQBLH016  |         |
| <b>FC</b>      | 250-350-450             | 2016 > 2018 | OEM   | White               |  R-CVHSQBN0016  | € 57,95 |
|                |                         |             |   | Black               |  R-CVHSQNR0016  |         |
|                |                         |             |   | Neon Yellow         |  R-CVHSQGF0016  |         |
|                |                         |             |   | Neon Pink           |  R-CVHSQFU0016  |         |
|                |                         |             |   | HSQ Red             |  R-CVHSQRQ0016  |         |
|                |                         |             |   | Quantum Grey        |  R-CVHSQGR0016  |         |
|                |                         |             |   | White               |  R-CVHSQBN0019  |         |
| <b>FC</b>      | 450 Rockstar Edition    | 2018 > 2022 | OEM 2018 > 2020<br>OEM 2021                                       | Black               |  R-CVHSQNR0019  | € 54,95 |
|                |                         |             |   | Neon Yellow         |  R-CVHSQGF0019  |         |
|                |                         |             |   | Quantum Grey        |  R-CVHSQGR0019  |         |
|                |                         |             |   | Limited Edition     |  |         |

# HUSQVARNA RADIATOR SHROUDS / CONVOGLIATORI ARIA RADIATORE

OEM original color - ☀️ fluorescent color

| MODEL        | CC                       | YEAR      | NOTES                  | COLOR         | CODE          | PRICE   |
|--------------|--------------------------|-----------|------------------------|---------------|---------------|---------|
| FC           | 250-450 Rockstar Edition | 2022      | OEM                    | Grey          | R-CVHSQGRH023 | € 43,95 |
|              |                          |           |                        | Black         | R-CVHSQNR0023 |         |
|              |                          |           |                        | White         | R-CVHSQBN0023 |         |
|              |                          |           |                        | HSQ Yellow    | R-CVHSQGQ0023 |         |
|              |                          |           |                        | Quantum Grey  | R-CVHSQGR0023 |         |
| FX           | 350-450                  | 2017-2018 | OEM                    | White         | R-CVHSQBN0016 | € 57,95 |
|              |                          |           |                        | HSQ Blue      | R-CVHSQBLH016 |         |
|              |                          |           |                        | Black         | R-CVHSQNR0016 |         |
|              |                          |           |                        | Neon Yellow   | R-CVHSQGF0016 |         |
|              |                          |           |                        | Neon Pink     | R-CVHSQFU0016 |         |
|              |                          |           |                        | HSQ Red       | R-CVHSQRQ0016 |         |
|              |                          |           |                        | Quantum Grey  | R-CVHSQGR0016 |         |
|              |                          |           |                        | White         | R-CVHSQBN0016 |         |
|              |                          |           |                        | HSQ Blue      | R-CVHSQBLH016 |         |
|              |                          |           |                        | Black         | R-CVHSQNR0016 |         |
| FS           | 450                      | 2017-2018 | Limited Edition<br>OEM | White         | R-CVHSQBN0016 | € 57,95 |
|              |                          |           |                        | HSQ Blue      | R-CVHSQBLH016 |         |
|              |                          |           |                        | Black         | R-CVHSQNR0016 |         |
|              |                          |           |                        | Neon Yellow   | R-CVHSQGF0016 |         |
|              |                          |           |                        | Neon Pink     | R-CVHSQFU0016 |         |
|              |                          |           | HSQ Red                | R-CVHSQRQ0016 |               |         |
|              |                          |           | Quantum Grey           | R-CVHSQGR0016 |               |         |
|              |                          |           | Limited Edition<br>OEM | White         | R-CVHSQBN0019 |         |
|              |                          |           |                        | Black         | R-CVHSQNR0019 |         |
|              |                          |           |                        | Neon Yellow   | R-CVHSQGF0019 |         |
| Quantum Grey | R-CVHSQGR0019            |           |                        |               |               |         |
| Grey         | R-CVHSQGRH023            |           |                        |               |               |         |
| FS           | 450                      | 2023      | Limited Edition<br>OEM | Black         | R-CVHSQNR0023 | € 43,95 |
|              |                          |           |                        | White         | R-CVHSQBN0023 |         |
|              |                          |           |                        | HSQ Yellow    | R-CVHSQGQ0023 |         |
|              |                          |           |                        | Quantum Grey  | R-CVHSQGR0023 |         |
|              |                          |           |                        | Grey          | R-CVHSQGRH023 |         |

**NEW**





R-FIHSQGA0019

## AVAILABLE COLORS



**OEM** original color - fluorescent color

| MODEL      | CC                  | YEAR        | NOTES  | COLOR           | CODE          | PRICE   |         |
|------------|---------------------|-------------|--|-----------------|---------------|---------|---------|
| TC         | 65                  | 2017 > 2023 | OEM  | White           | R-FIHSQBN0065 | € 59,95 |         |
|            |                     |             |  | Black           | R-FIHSQNR0065 |         |         |
|            |                     |             |  | Neon Yellow     | R-FIHSQGF0065 |         |         |
| TC         | 85                  | 2014 > 2017 | OEM Single - left  | White           | R-FIKTMBNSX85 | € 27,95 |         |
|            |                     |             |  | Black           | R-FIKTMNRSX85 |         |         |
|            |                     |             |  | Neon Yellow     | R-FIHSQGF0185 |         |         |
| TC         | 85                  | 2018 > 2023 | OEM  | White           | R-FIHSQBN0185 | € 59,95 |         |
|            |                     |             |  | Black           | R-FIHSQNR0185 |         |         |
|            |                     |             |  | Neon Yellow     | R-FIHSQGF0185 |         |         |
| CR / WR    | 125                 | 2006 > 2008 | OEM 2007-2008  | White           | R-FIHSQBN0005 | € 57,95 |         |
| CR / WR    | 125                 | 2009 > 2013 | OEM  | White           | R-FIHSQBN0009 | € 62,95 |         |
|            |                     |             |  | Black           | R-FIHSQNR0009 |         |         |
| CR / WR    | 250-300             | 2006 > 2013 | OEM 2007-2008  | White           | R-FIHSQBN0005 | € 57,95 |         |
| TC / TE    | 250-310-450-510     | 2005 > 2007 | OEM 2007-2008  | White           | R-FIHSQBN0005 | € 57,95 |         |
| TC / TE    | 250-310             | 2008 > 2013 | OEM 2008 > 2013  | White           | R-FIHSQBN0008 | € 57,95 |         |
|            |                     |             |  | Black           | R-FIHSQNR0008 |         |         |
| TC / TE    | 450-510             | 2008 > 2010 | OEM  | White           | R-FIHSQBN0008 | € 57,95 |         |
|            |                     |             |  | Black           | R-FIHSQNR0008 |         |         |
| TC / TE    | 449-511             | 2011 > 2013 | OEM  | HSQ Red         | R-FIHSQRQ0011 | € 85,95 |         |
|            |                     |             |  | White           | R-FIHSQBN0011 |         |         |
| TC         | 125                 | 2014-2015   | OEM  | White           | R-FIHSQBN0014 | € 57,95 |         |
|            |                     |             |  | Black           | R-FIHSQNR0014 |         |         |
|            |                     |             |  | Black           | R-FIHSQNR0014 |         |         |
| TC         | 125                 | 2016 > 2018 | OEM  | White           | R-FIHSQBN0016 | € 65,95 |         |
|            |                     |             |  | Black           | R-FIHSQNR0016 |         |         |
|            |                     |             |  | Neon Yellow     | R-FIHSQGF0016 |         |         |
|            |                     |             |  | Neon Pink       | R-FIHSQFU0016 |         |         |
|            |                     |             |  | Quantum Grey    | R-FIHSQGR0016 |         |         |
|            |                     |             |  | Anthracite Grey | R-FIHSQGA0019 |         |         |
| TC-FC      | 125-250-350-450     | 2019 > 2022 | Limited Edition<br>OEM 2020-2021   | Black           | R-FIHSQNR0019 | € 41,95 |         |
|            |                     |             |  | Neon Yellow     | R-FIHSQGF0019 |         |         |
|            |                     |             |  | Quantum Grey    | R-FIHSQGR0019 |         |         |
|            |                     |             |  | White           | R-FIHSQBN0019 |         |         |
|            |                     |             |  | White           | R-FIHSQBN0023 |         | € 34,95 |
|            |                     |             |  | Black           | R-FIHSQNR0023 |         |         |
| HSQ Yellow | R-FIHSQGG0023       |             |  |                 |               |         |         |
| TC-FC      | 125-250-300-350-450 | 2023        | OEM - Left + Right panel<br>Left + Right panel<br>Left + Right panel<br>Left + Right panel | Quantum Grey    | R-FIHSQGR0023 | € 22,95 |         |
|            |                     |             |  | White           | R-FIHSQBNDX23 |         |         |
|            |                     |             |  | Black           | R-FIHSQNRDX23 |         |         |
|            |                     |             |  | HSQ Yellow      | R-FIHSQGGDX23 |         |         |
| TC-FC      | 125-250-300-350-450 | 2023        | OEM - Right panel<br>Right panel<br>Right panel<br>Right panel                             | Quantum Grey    | R-FIHSQGRDX23 | € 22,95 |         |
|            |                     |             |  | White           | R-FIHSQBNDX23 |         |         |
|            |                     |             |  | Black           | R-FIHSQNRDX23 |         |         |
|            |                     |             |  | HSQ Yellow      | R-FIHSQGGDX23 |         |         |
| TC         | 250                 | 2014 > 2016 | OEM  | White           | R-FIHSQBN0014 | € 57,95 |         |
|            |                     |             |  | Black           | R-FIHSQNR0014 |         |         |
| TC         | 250                 | 2017-2018   | OEM  | White           | R-FIHSQBN0016 | € 65,95 |         |
|            |                     |             |  | Black           | R-FIHSQNR0016 |         |         |
|            |                     |             |  | Neon Yellow     | R-FIHSQGF0016 |         |         |
|            |                     |             |  | Neon Pink       | R-FIHSQFU0016 |         |         |
|            |                     |             |  | Quantum Grey    | R-FIHSQGR0016 |         |         |
|            |                     |             |  | Anthracite Grey | R-FIHSQGA0019 |         |         |
| TX         | 250-300             | 2017-2018   | Limited Edition<br>OEM   | White           | R-FIHSQBN0016 | € 65,95 |         |
|            |                     |             |  | Black           | R-FIHSQNR0016 |         |         |
|            |                     |             |  | Neon Yellow     | R-FIHSQGF0016 |         |         |
|            |                     |             |  | Neon Pink       | R-FIHSQFU0016 |         |         |
|            |                     |             |  | Quantum Grey    | R-FIHSQGR0016 |         |         |
|            |                     |             |  | Anthracite Grey | R-FIHSQGA0019 |         |         |
| TX         | 125-250             | 2017 > 2019 | Limited Edition<br>OEM   | White           | R-FIHSQBN0016 | € 65,95 |         |
|            |                     |             |  | Black           | R-FIHSQNR0016 |         |         |
|            |                     |             |  | Neon Yellow     | R-FIHSQGF0016 |         |         |
|            |                     |             |  | Neon Pink       | R-FIHSQFU0016 |         |         |
|            |                     |             |  | Quantum Grey    | R-FIHSQGR0016 |         |         |
|            |                     |             |  | Anthracite Grey | R-FIHSQGA0019 |         |         |

**NEW**

**NEW**

# HUSQVARNA SIDE PANELS / TABELLE LATERALI PORTANUMERO



R-FIHSQBN0016



R-FIHSQFU0016



R-FIHSQGF0016



R-FIHSQGR0016



R-FIHSQNR0016

**OEM** original color - fluorescent color

| MODEL   | CC                       | YEAR        | NOTES  | COLOR           | CODE           | PRICE   |
|---------|--------------------------|-------------|--|-----------------|----------------|---------|
| TX / FX | 300-350-450              | 2019 > 2022 | OEM 2020-2021  | Anthracite Grey | R-FIHSQGA0019  | € 41,95 |
|         |                          |             |  | Black           | R-FIHSQNR0019  |         |
|         |                          |             |  | Neon Yellow     | R-FIHSQGF0019  |         |
|         |                          |             |  | Quantum Grey    | R-FIHSQGR0019  |         |
|         |                          |             |  | White           | R-FIHSQBN0019  |         |
| TX-FX   | 300-350-450              | 2023        | OEM - Left + Right panel<br>Left + Right panel<br>Left + Right panel | White           | R-FIHSQBN0023  | € 34,95 |
|         |                          |             |  | Black           | R-FIHSQNR0023  |         |
|         |                          |             |  | HSQ Yellow      | R-FIHSQGF0023  |         |
|         |                          |             |  | Quantum Grey    | R-FIHSQGR0023  |         |
|         |                          |             |  | White           | R-FIHSQBN0023  |         |
| TX-FX   | 300-350-450              | 2023        | OEM - Right panel<br>Right panel<br>Right panel<br>Right panel       | White           | R-FIHSQBNDX23  | € 22,95 |
|         |                          |             |  | Black           | R-FIHSQNRDX23  |         |
|         |                          |             |  | HSQ Yellow      | R-FIHSQGFQDX23 |         |
|         |                          |             |  | Quantum Grey    | R-FIHSQGRDX23  |         |
|         |                          |             |  | White           | R-FIHSQBNDX23  |         |
| TE / FE | 125-250-300-350-450-501  | 2014 > 2016 | OEM  | White           | R-FIHSQBN0014  | € 57,95 |
|         |                          |             |  | Black           | R-FIHSQNR0014  |         |
| TE / FE | 150-250-300-350-450-501  | 2017 > 2019 | OEM  | White           | R-FIHSQBN0016  | € 65,95 |
|         |                          |             |  | Black           | R-FIHSQNR0016  |         |
|         |                          |             |  | Neon Yellow     | R-FIHSQGF0016  |         |
|         |                          |             |  | Neon Pink       | R-FIHSQFU0016  |         |
|         |                          |             |  | Quantum Grey    | R-FIHSQGR0016  |         |
| TE / FE | 150-250-300-350-450-501  | 2020 > 2023 | OEM 2020-2021  | Anthracite Grey | R-FIHSQGA0019  | € 41,95 |
|         |                          |             |  | Black           | R-FIHSQNR0019  |         |
|         |                          |             |  | Neon Yellow     | R-FIHSQGF0019  |         |
|         |                          |             |  | Quantum Grey    | R-FIHSQGR0019  |         |
|         |                          |             |  | White           | R-FIHSQBN0019  |         |
| FC      | 250-350-450              | 2014-2015   | OEM  | White           | R-FIHSQBN0014  | € 57,95 |
|         |                          |             |  | Black           | R-FIHSQNR0014  |         |
| FC      | 250-350-450              | 2016 > 2018 | OEM  | White           | R-FIHSQBN0016  | € 65,95 |
|         |                          |             |  | Black           | R-FIHSQNR0016  |         |
|         |                          |             |  | Neon Yellow     | R-FIHSQGF0016  |         |
|         |                          |             |  | Neon Pink       | R-FIHSQFU0016  |         |
|         |                          |             |  | Quantum Grey    | R-FIHSQGR0016  |         |
| FC      | 450 Rockstar Edition     | 2018 > 2022 | OEM  | Anthracite Grey | R-FIHSQGA0019  | € 41,95 |
|         |                          |             |  | Black           | R-FIHSQNR0019  |         |
|         |                          |             |  | Neon Yellow     | R-FIHSQGF0019  |         |
|         |                          |             |  | Quantum Grey    | R-FIHSQGR0019  |         |
|         |                          |             |  | White           | R-FIHSQBN0019  |         |
| FC      | 250-450 Rockstar Edition | 2022        | OEM - Left + Right panel<br>Left + Right panel<br>Left + Right panel | White           | R-FIHSQBN0023  | € 34,95 |
|         |                          |             |  | Black           | R-FIHSQNR0023  |         |
|         |                          |             |  | HSQ Yellow      | R-FIHSQGF0023  |         |
|         |                          |             |  | Quantum Grey    | R-FIHSQGR0023  |         |
|         |                          |             |  | White           | R-FIHSQBN0023  |         |
| FC      | 250-450 Rockstar Edition | 2022        | OEM - Right panel<br>Right panel<br>Right panel<br>Right panel       | White           | R-FIHSQBNDX23  | € 22,95 |
|         |                          |             |  | Black           | R-FIHSQNRDX23  |         |
|         |                          |             |  | Neon Yellow     | R-FIHSQGFQDX23 |         |
|         |                          |             |  | Quantum Grey    | R-FIHSQGRDX23  |         |
|         |                          |             |  | White           | R-FIHSQBNDX23  |         |
| FX      | 350-450                  | 2017-2018   | OEM  | White           | R-FIHSQBN0016  | € 65,95 |
|         |                          |             |  | Black           | R-FIHSQNR0016  |         |
|         |                          |             |  | Neon Yellow     | R-FIHSQGF0016  |         |
|         |                          |             |  | Neon Pink       | R-FIHSQFU0016  |         |
|         |                          |             |  | Quantum Grey    | R-FIHSQGR0016  |         |
| FS      | 450                      | 2017-2018   | OEM  | White           | R-FIHSQBN0016  | € 65,95 |
|         |                          |             |  | Black           | R-FIHSQNR0016  |         |
|         |                          |             |  | Neon Yellow     | R-FIHSQGF0016  |         |
|         |                          |             |  | Neon Pink       | R-FIHSQFU0016  |         |
|         |                          |             |  | Quantum Grey    | R-FIHSQGR0016  |         |
| FS      | 450                      | 2019 > 2022 | OEM  | Anthracite Grey | R-FIHSQGA0019  | € 41,95 |
|         |                          |             |  | Black           | R-FIHSQNR0019  |         |
|         |                          |             |  | Neon Yellow     | R-FIHSQGF0019  |         |
|         |                          |             |  | Quantum Grey    | R-FIHSQGR0019  |         |
|         |                          |             |  | White           | R-FIHSQBN0019  |         |
| FS      | 450                      | 2023        | OEM - Left + Right panel<br>Left + Right panel<br>Left + Right panel | White           | R-FIHSQBN0023  | € 34,95 |
|         |                          |             |  | Black           | R-FIHSQNR0023  |         |
|         |                          |             |  | HSQ Yellow      | R-FIHSQGF0023  |         |
|         |                          |             |  | Quantum Grey    | R-FIHSQGR0023  |         |
|         |                          |             |  | White           | R-FIHSQBN0023  |         |
| FS      | 450                      | 2023        | OEM - Right panel<br>Right panel<br>Right panel<br>Right panel       | White           | R-FIHSQBNDX23  | € 22,95 |
|         |                          |             |  | Black           | R-FIHSQNRDX23  |         |
|         |                          |             |  | HSQ Yellow      | R-FIHSQGFQDX23 |         |
|         |                          |             |  | Quantum Grey    | R-FIHSQGRDX23  |         |
|         |                          |             |  | White           | R-FIHSQBNDX23  |         |

# HUSQVARNA AIR BOX COVERS / COPERCHI LATERALI CASSA FILTRO



R-FILCFHSQGR99



R-FILCFHSQGF99



R-FILCFHSQBN19

## AVAILABLE COLORS

- Black
- White
- Quantum Grey
- Neon Yellow

**OEM** original color - fluorescent color

| MODEL  | CC                       | YEAR        | NOTES | COLOR        | CODE           | PRICE   |
|--|--------------------------|-------------|-------|--------------|----------------|---------|
| <b>TC / FC</b><br>left and right airbox side panel | 125-250-350-450          | 2019 > 2022 | OEM   | White        | R-FILCFHSQBN19 | € 54,95 |
|  |                          |             |       | Black        | R-FILCFHSQNR19 |         |
|  |                          |             |       | Neon Yellow  | R-FILCFHSQGF19 |         |
|  |                          |             |       | Quantum Grey | R-FILCFHSQGR19 |         |
| <b>TC / FC</b><br>left and right airbox side panel | 125-250-300-350-450      | 2023        | OEM   | White        | R-FILCFHSQBN23 | € 22,95 |
|  |                          |             |       | Black        | R-FILCFHSQNR23 |         |
|  |                          |             |       | HSQ Yellow   | R-FILCFHSQGQ23 |         |
|  |                          |             |       | Quantum Grey | R-FILCFHSQGR23 |         |
| <b>TC / FC</b><br>vented left airbox side panel    | 125-250-300-350-450      | 2023        | OEM   | White        | R-FILCFHSQBN93 | € 22,95 |
|  |                          |             |       | Black        | R-FILCFHSQNR93 |         |
|  |                          |             |       | HSQ Yellow   | R-FILCFHSQGQ93 |         |
|  |                          |             |       | Quantum Grey | R-FILCFHSQGR93 |         |
| <b>TX / FX</b><br>left and right airbox side panel | 300-350-450              | 2019 > 2022 | OEM   | White        | R-FILCFHSQBN19 | € 54,95 |
|  |                          |             |       | Black        | R-FILCFHSQNR19 |         |
|  |                          |             |       | Neon Yellow  | R-FILCFHSQGF19 |         |
|  |                          |             |       | Quantum Grey | R-FILCFHSQGR19 |         |
| <b>TX / FX</b><br>left and right airbox side panel | 300-350-450              | 2023        | OEM   | White        | R-FILCFHSQBN23 | € 22,95 |
|  |                          |             |       | Black        | R-FILCFHSQNR23 |         |
|  |                          |             |       | HSQ Yellow   | R-FILCFHSQGQ23 |         |
|  |                          |             |       | Quantum Grey | R-FILCFHSQGR23 |         |
| <b>TX / FX</b><br>vented left airbox side panel    | 300-350-450              | 2023        | OEM   | White        | R-FILCFHSQBN93 | € 22,95 |
|  |                          |             |       | Black        | R-FILCFHSQNR93 |         |
|  |                          |             |       | HSQ Yellow   | R-FILCFHSQGQ93 |         |
|  |                          |             |       | Quantum Grey | R-FILCFHSQGR93 |         |
| <b>FC</b><br>left and right airbox side panel      | 450 Rockstar Edition     | 2018 > 2022 | OEM   | White        | R-FILCFHSQBN19 | € 54,95 |
|  |                          |             |       | Black        | R-FILCFHSQNR19 |         |
|  |                          |             |       | Neon Yellow  | R-FILCFHSQGF19 |         |
|  |                          |             |       | Quantum Grey | R-FILCFHSQGR19 |         |
| <b>FC</b><br>left and right airbox side panel      | 250-450 Rockstar Edition | 2022        | OEM   | White        | R-FILCFHSQBN23 | € 22,95 |
|  |                          |             |       | Black        | R-FILCFHSQNR23 |         |
|  |                          |             |       | HSQ Yellow   | R-FILCFHSQGQ23 |         |
|  |                          |             |       | Quantum Grey | R-FILCFHSQGR23 |         |
| <b>FC</b><br>vented left airbox side panel         | 250-450 Rockstar Edition | 2022        | OEM   | White        | R-FILCFHSQBN93 | € 22,95 |
|  |                          |             |       | Black        | R-FILCFHSQNR93 |         |
|  |                          |             |       | HSQ Yellow   | R-FILCFHSQGQ93 |         |
|  |                          |             |       | Quantum Grey | R-FILCFHSQGR93 |         |
| <b>FS</b><br>left and right airbox side panel      | 450                      | 2019 > 2022 | OEM   | White        | R-FILCFHSQBN19 | € 54,95 |
|  |                          |             |       | Black        | R-FILCFHSQNR19 |         |
|  |                          |             |       | Neon Yellow  | R-FILCFHSQGF19 |         |
|  |                          |             |       | Quantum Grey | R-FILCFHSQGR19 |         |
| <b>TE / FE</b><br>left and right airbox side panel | 150-250-300-350-450-501  | 2020 > 2023 | OEM   | White        | R-FILCFHSQBN19 | € 54,95 |
|  |                          |             |       | Black        | R-FILCFHSQNR19 |         |
|  |                          |             |       | Neon Yellow  | R-FILCFHSQGF19 |         |
|  |                          |             |       | Quantum Grey | R-FILCFHSQGR19 |         |
| <b>TC / FC</b><br>vented left airbox side panel    | 125-250-350-450          | 2019 > 2022 | OEM   | White        | R-FILCFHSQBN99 | € 25,95 |
|  |                          |             |       | Black        | R-FILCFHSQNR99 |         |
|  |                          |             |       | Neon Yellow  | R-FILCFHSQGF99 |         |
|  |                          |             |       | Quantum Grey | R-FILCFHSQGR99 |         |
| <b>TX / FX</b><br>vented left airbox side panel    | 300-350-450              | 2019 > 2022 | OEM   | White        | R-FILCFHSQBN99 | € 25,95 |
|  |                          |             |       | Black        | R-FILCFHSQNR99 |         |
|  |                          |             |       | Neon Yellow  | R-FILCFHSQGF99 |         |
|  |                          |             |       | Quantum Grey | R-FILCFHSQGR99 |         |

# HUSQVARNA AIR BOX COVERS / COPERCHI LATERALI CASSA FILTRO

OEM original color - ☀ fluorescent color

| MODEL   | CC                      | YEAR        | NOTES           | COLOR           | CODE            | PRICE   |
|---|-------------------------|-------------|-----------------|-----------------|-----------------|---------|
| <b>FC</b><br>vented left airbox side panel      | 450 Rockstar Edition    | 2018 > 2022 | OEM             | White           | R-FILCFHSQLBN99 | € 25,95 |
|   |                         |             |                 | Black           | R-FILCFHSQLNR99 |         |
|   |                         |             |                 | Neon Yellow ☀   | R-FILCFHSQLGF99 |         |
|   |                         |             |                 | Quantum Grey    | R-FILCFHSQLGR99 |         |
| <b>FS</b><br>vented left airbox side panel      | 450                     | 2019 > 2022 | OEM             | White           | R-FILCFHSQLBN99 | € 25,95 |
|   |                         |             |                 | Black           | R-FILCFHSQLNR99 |         |
|   |                         |             |                 | Neon Yellow ☀   | R-FILCFHSQLGF99 |         |
|   |                         |             |                 | Quantum Grey    | R-FILCFHSQLGR99 |         |
| <b>FS</b><br>left and right airbox side panel   | 450                     | 2023        | Limited Edition | White           | R-FILCFHSQLBN23 | € 22,95 |
|   |                         |             | OEM             | Black           | R-FILCFHSQLNR23 |         |
|   |                         |             | HSQ Yellow      | R-FILCFHSQLQ23  |                 |         |
|   |                         |             | Quantum Grey    | R-FILCFHSQLGR23 |                 |         |
| <b>FS</b><br>vented left airbox side panel      | 450                     | 2023        | OEM             | White           | R-FILCFHSQLBN93 | € 22,95 |
|   |                         |             |                 | Black           | R-FILCFHSQLNR93 |         |
|   |                         |             |                 | HSQ Yellow      | R-FILCFHSQLQ93  |         |
|   |                         |             |                 | Quantum Grey    | R-FILCFHSQLGR93 |         |
| <b>TE / FE</b><br>vented left airbox side panel | 150-250-300-350-450-501 | 2020 > 2023 | OEM             | White           | R-FILCFHSQLBN99 | € 25,95 |
|   |                         |             |                 | Black           | R-FILCFHSQLNR99 |         |
|   |                         |             |                 | Neon Yellow ☀   | R-FILCFHSQLGF99 |         |
|   |                         |             |                 | Limited Edition | Quantum Grey    |         |

## AVAILABLE COLORS

Black Neutral

Pack of 5 pcs  
R-BOCKTMNR516



OEM original color

| MODEL              | CC        | YEAR        | NOTES                      | COLOR   | CODE          | PRICE  |
|--------------------|-----------|-------------|----------------------------|---------|---------------|--------|
| <b>TC</b>          | 85        | 2018 > 2023 | FOR SIDE PANELS AND AIRBOX | Black   | R-BOCKTMNR516 | € 9,95 |
|                    |           |             |                            | Neutral | R-BOCKTMNT516 |        |
| <b>TC/FC/FX/FS</b> | 125 > 450 | 2016 > 2023 | FOR SIDE PANELS AND AIRBOX | Black   | R-BOCKTMNR516 | € 9,95 |
|                    |           |             |                            | Neutral | R-BOCKTMNT516 |        |
| <b>TX/TE/FE/FS</b> | 125 > 501 | 2017 > 2023 | FOR SIDE PANELS AND AIRBOX | Black   | R-BOCKTMNR516 | € 9,95 |
|                    |           |             |                            | Neutral | R-BOCKTMNT516 |        |





R-PSHSQNR0016

NEON



R-PSHSQFU0016

NEON



R-PSHSQGF0016



R-PSKTMGQ0023

R-PSKTMGQ0093

## AVAILABLE COLORS

- Black
- HSQ Blue
- White
- Neon Yellow
- Neon Pink
- HSQ Yellow

**OEM** original color - fluorescent color

| MODEL       | CC                          | YEAR        | NOTES   | COLOR           | CODE          | PRICE   |         |     |              |               |         |
|-------------|-----------------------------|-------------|---|-----------------|---------------|---------|---------|-----|--------------|---------------|---------|
| TC          | 65                          | 2019 > 2023 | OEM - Fits on model 2017-18   | HSQ Yellow      | R-PSKTMGQ1965 | € 29,95 |         |     |              |               |         |
|             |                             |             |   | White           | R-PSKTMBN1965 |         |         |     |              |               |         |
|             |                             |             |   | Black           | R-PSKTMNR1965 |         |         |     |              |               |         |
|             |                             |             |   | Neon Yellow     | R-PSKTMGF1965 |         |         |     |              |               |         |
| TC          | 85                          | 2014>2017   | OEM 2014 > 2016   | HSQ Yellow      | R-PSKTMGQ0985 | € 31,95 |         |     |              |               |         |
|             |                             |             |   | HSQ Blue        | R-PSKTMBLH985 |         |         |     |              |               |         |
|             |                             |             |   | White           | R-PSKTMBN0985 |         |         |     |              |               |         |
|             |                             |             |   | Black           | R-PSKTMNR0985 |         |         |     |              |               |         |
|             |                             |             |   | Neon Yellow     | R-PSKTMGF0985 |         |         |     |              |               |         |
| TC          | 85                          | 2018 > 2023 | OEM   | HSQ Yellow      | R-PSKTMGQ0185 | € 31,95 |         |     |              |               |         |
|             |                             |             |   | White           | R-PSKTMBN0185 |         |         |     |              |               |         |
|             |                             |             |   | Black           | R-PSKTMNR0185 |         |         |     |              |               |         |
|             |                             |             |   | Neon Yellow     | R-PSKTMGF0185 |         |         |     |              |               |         |
| CR / WR     | 125-250-300                 | 2008 > 2013 | OEM Marzocchi 50  | Black           | R-PSHSQNR0011 | € 38,95 |         |     |              |               |         |
|             |                             |             |   | White           | R-PSHSQBN0011 |         |         |     |              |               |         |
| TC/TE/SMRR  | 250-310-450-510-530         | 2008 > 2013 | OEM Marzocchi 50  | Black           | R-PSHSQNR0011 | € 38,95 |         |     |              |               |         |
|             |                             |             |   | White           | R-PSHSQBN0011 |         |         |     |              |               |         |
| TC          | 250                         | 2007 > 2013 | OEM Marzocchi 50  | Black           | R-PSHSQNR0011 | € 38,95 |         |     |              |               |         |
|             |                             |             |   | White           | R-PSHSQBN0011 |         |         |     |              |               |         |
| TC / FC     | 125-250-350-450             | 2014        | OEM   | HSQ Yellow      | R-PSKTMGQ0008 | € 34,95 |         |     |              |               |         |
|             |                             |             |   | White           | R-PSKTMBN0008 |         |         |     |              |               |         |
|             |                             |             |   | Black           | R-PSKTMNR0008 |         |         |     |              |               |         |
| TE / FE     | 125-250-300-350-450-501     | 2014-2015   | OEM   | HSQ Yellow      | R-PSKTMGQ0008 | € 34,95 |         |     |              |               |         |
|             |                             |             |   | White           | R-PSKTMBN0008 |         |         |     |              |               |         |
|             |                             |             |   | Black           | R-PSKTMNR0008 |         |         |     |              |               |         |
| TC / FC     | 125-250-350-450             | 2015        | OEM   | HSQ Yellow      | R-PSKTMGQ0015 | € 34,95 |         |     |              |               |         |
|             |                             |             |   | Black           | R-PSKTMNR0015 |         |         |     |              |               |         |
| TC/FC/TX/FX | 125-150-250-300-350-450-501 | 2016 > 2022 | OEM 2018-2021 - Rockstar Edition 2018-2021<br>OEM 2017 and 2022             | HSQ Yellow      | R-PSHSQSQ0016 | € 34,95 |         |     |              |               |         |
|             |                             |             |   | HSQ Blue        | R-PSHSQBLH016 |         |         |     |              |               |         |
|             |                             |             |   | White 2020      | R-PSHSQBN0020 |         |         |     |              |               |         |
|             |                             |             |   | Black           | R-PSHSQNR0016 |         |         |     |              |               |         |
|             |                             |             |   | Neon Yellow     | R-PSHSQGF0016 |         |         |     |              |               |         |
|             |                             |             |   | Neon Pink       | R-PSHSQFU0016 |         |         |     |              |               |         |
|             |                             |             |   | Quantum Grey    | R-PSHSQGR0016 |         |         |     |              |               |         |
|             |                             |             |   | Anthracite Grey | R-PSHSQGA0020 |         |         |     |              |               |         |
|             |                             |             |   | HSQ Yellow      | R-PSKTMGQ0023 |         | € 29,95 |     |              |               |         |
|             |                             |             |   | HSQ White       | R-PSKTMBNH023 |         |         |     |              |               |         |
| Black       | R-PSKTMNR0023               |             |   |                 |               |         |         |     |              |               |         |
| FC          | 250-450 Rockstar Edition    | 2022        | OEM   | Neon Yellow     | R-PSKTMGF0023 | € 29,95 |         |     |              |               |         |
|             |                             |             |   | Quantum Grey    | R-PSKTMGR0023 |         |         |     |              |               |         |
|             |                             |             |   | HSQ Yellow      | R-PSKTMGQ0023 |         |         |     |              |               |         |
|             |                             |             |   | HSQ White       | R-PSKTMBNH023 |         |         |     |              |               |         |
|             |                             |             |   | Black           | R-PSKTMNR0023 |         |         |     |              |               |         |
|             |                             |             |   | Neon Yellow     | R-PSKTMGF0023 |         |         |     |              |               |         |
|             |                             |             |   | Quantum Grey    | R-PSKTMGR0023 |         |         |     |              |               |         |
|             |                             |             |   | HSQ Yellow      | R-PSHSQSQ0016 |         | € 34,95 |     |              |               |         |
|             |                             |             |   | HSQ Blue        | R-PSHSQBLH016 |         |         |     |              |               |         |
|             |                             |             |   | White 2020      | R-PSHSQBN0020 |         |         |     |              |               |         |
| Black       | R-PSHSQNR0016               |             |   |                 |               |         |         |     |              |               |         |
| TE/FE       | 125-150-250-300-350-450-501 | 2016 > 2023 | OEM 2018-2021 - Rockstar Edition 2018-2021<br>OEM 2017<br>OEM 2016 and 2023 | Neon Yellow     | R-PSHSQGF0016 | € 34,95 |         |     |              |               |         |
|             |                             |             |   | Neon Pink       | R-PSHSQFU0016 |         |         |     |              |               |         |
|             |                             |             |   | Quantum Grey    | R-PSHSQGR0016 |         |         |     |              |               |         |
|             |                             |             |   | Anthracite Grey | R-PSHSQGA0020 |         |         |     |              |               |         |
|             |                             |             |   | HSQ Yellow      | R-PSKTMGQ0023 |         | € 29,95 |     |              |               |         |
|             |                             |             |   | HSQ White       | R-PSKTMBNH023 |         |         |     |              |               |         |
|             |                             |             |   | Black           | R-PSKTMNR0023 |         |         |     |              |               |         |
|             |                             |             |   | FS              | 450           |         | 2023    | OEM | Neon Yellow  | R-PSKTMGF0023 | € 29,95 |
|             |                             |             |   |                 |               |         |         |     | Quantum Grey | R-PSKTMGR0023 |         |
|             |                             |             |   |                 |               |         |         |     | HSQ Yellow   | R-PSKTMGQ0023 |         |
| HSQ White   | R-PSKTMBNH023               |             |   |                 |               |         |         |     |              |               |         |
| Black       | R-PSKTMNR0023               |             |   |                 |               |         |         |     |              |               |         |

**NEW**

**NEW**

**FACTORY EDITION**



Parasteli Factory avvolgenti, con una più ampia superficie di protezione rispetto agli originali.

*Enveloping factory fork protectors with an enhanced cover surface for a better protection.*

**OEM** original color - fluorescent color

| MODEL       | CC                          | YEAR | NOTES | COLOR        | CODE | PRICE         |         |
|-------------|-----------------------------|------|-------|--------------|------|---------------|---------|
| TC/FC/TX/FX | 125-150-250-300-350-450-501 | 2023 | OEM   | HSQ Yellow   |      | R-PSKTMGQ0093 | € 29,95 |
|             |                             |      |       | HSQ White    |      | R-PSKTMBNH093 |         |
|             |                             |      |       | Black        |      | R-PSKTMNR0093 |         |
|             |                             |      |       | Neon Yellow  |      | R-PSKTMGF0093 |         |
|             |                             |      |       | Quantum Grey |      | R-PSKTMGR0093 |         |
| FC          | 250-450 Rockstar Edition    | 2022 | OEM   | HSQ Yellow   |      | R-PSKTMGQ0093 | € 29,95 |
|             |                             |      |       | HSQ White    |      | R-PSKTMBNH093 |         |
|             |                             |      |       | Black        |      | R-PSKTMNR0093 |         |
|             |                             |      |       | Neon Yellow  |      | R-PSKTMGF0093 |         |
|             |                             |      |       | Quantum Grey |      | R-PSKTMGR0093 |         |
| FS          | 450                         | 2023 | OEM   | HSQ Yellow   |      | R-PSKTMGQ0093 | € 29,95 |
|             |                             |      |       | HSQ White    |      | R-PSKTMBNH093 |         |
|             |                             |      |       | Black        |      | R-PSKTMNR0093 |         |
|             |                             |      |       | Neon Yellow  |      | R-PSKTMGF0093 |         |
|             |                             |      |       | Quantum Grey |      | R-PSKTMGR0093 |         |



# HUSQVARNA FRONT NUMBER PLATE / TABELLA PORTANUMERO ANTERIORE



REPLICA

R-TBHSQBMBL23



FACTORY EDITION



R-TBHSQBMBL93

## AVAILABLE COLORS

|  |       |  |                  |
|--|-------|--|------------------|
|  | Black |  | White-HSQ Yellow |
|  | White |  | Neon Yellow      |
|  |       |  | Quantum Grey     |

**OEM** original color - fluorescent color

| MODEL              | CC                       | YEAR           | NOTES                  | COLOR              | CODE | PRICE           |         |
|--------------------|--------------------------|----------------|------------------------|--------------------|------|-----------------|---------|
| TC                 | 65                       | 2017 > 2023    | OEM                    | White              |      | R-TBHSQBMBL0065 | € 28,95 |
|                    |                          |                |                        | Black              |      | R-TBHSQBMR0065  |         |
|                    |                          |                |                        | Neon Yellow        |      | R-TBHSQBGF0065  |         |
| TC                 | 85                       | 2014 > 2017    | OEM                    | White              |      | R-TBHSQBMBL0085 | € 27,95 |
|                    |                          |                |                        | Black              |      | R-TBHSQBMR0085  |         |
| TC                 | 85                       | 2018 > 2023    | OEM                    | White              |      | R-TBHSQBMBL0185 | € 28,95 |
|                    |                          |                |                        | Black              |      | R-TBHSQBMR0185  |         |
|                    |                          |                |                        | Neon Yellow        |      | R-TBHSQBGF0185  |         |
| TC / TE            | 449-511                  | 2011 > 2013    | OEM                    | White              |      | R-TBHSQBMBL0011 | € 25,95 |
| TC / FC            | 125                      | 2014-2015      | OEM                    | White              |      | R-TBHSQBMBL0014 | € 30,95 |
|                    |                          |                |                        | Black              |      | R-TBHSQBMR0014  |         |
| TC                 | 125                      | 2016 > 2018    | OEM                    | White              |      | R-TBHSQBMBL0016 | € 34,95 |
|                    |                          |                |                        | Black              |      | R-TBHSQBMR0016  |         |
|                    |                          |                |                        | Neon Yellow        |      | R-TBHSQBGF0016  |         |
|                    |                          |                |                        | Quantum Grey       |      | R-TBHSQBGR0016  |         |
|                    |                          |                |                        | White              |      | R-TBHSQBMBL0014 |         |
| TC                 | 250                      | 2014 > 2016    | OEM                    | Black              |      | R-TBHSQBMR0014  | € 30,95 |
|                    |                          |                |                        | White              |      | R-TBHSQBMBL0014 |         |
|                    |                          |                |                        | Black              |      | R-TBHSQBMR0014  |         |
| TC / TX            | 250-300                  | 2017-2018      | OEM                    | White              |      | R-TBHSQBMBL0016 | € 34,95 |
|                    |                          |                |                        | Black              |      | R-TBHSQBMR0016  |         |
|                    |                          |                |                        | Neon Yellow        |      | R-TBHSQBGF0016  |         |
|                    |                          |                |                        | Quantum Grey       |      | R-TBHSQBGR0016  |         |
|                    |                          |                |                        | White              |      | R-TBHSQBMBL0016 |         |
| TC / FC            | 125-250-350-450          | 2019 > 2022    | OEM                    | White/HSQ Yellow   |      | R-TBHSQBNGQ19   | € 36,95 |
|                    |                          |                |                        | White              |      | R-TBHSQBMBL0019 |         |
|                    |                          |                |                        | Black              |      | R-TBHSQBMR0019  |         |
|                    |                          |                |                        | Neon Yellow        |      | R-TBHSQBGF0019  |         |
|                    |                          |                |                        | Quantum Grey       |      | R-TBHSQBGR0019  |         |
| TC / FC            | 125-250-300-350-450      | 2023           | Limited Edition<br>OEM | White/HSQ Blue     |      | R-TBHSQBMBL23   | € 29,95 |
|                    |                          |                |                        | White/Black        |      | R-TBHSQBMBL23   |         |
|                    |                          |                |                        | Black              |      | R-TBHSQBMR0023  |         |
|                    |                          |                |                        | White              |      | R-TBHSQBMBL0023 |         |
|                    |                          |                |                        | HSQ Yellow/Black   |      | R-TBHSQBQNR23   |         |
|                    |                          |                |                        | Quantum Grey/Black |      | R-TBHSQBGRNR23  |         |
|                    |                          |                |                        | White/HSQ Yellow   |      | R-TBHSQBNGQ19   |         |
|                    |                          |                |                        | White              |      | R-TBHSQBMBL0019 |         |
| TX / FX            | 300-350-450              | 2019 > 2022    | OEM                    | Black              |      | R-TBHSQBMR0019  | € 36,95 |
|                    |                          |                |                        | Neon Yellow        |      | R-TBHSQBGF0019  |         |
|                    |                          |                |                        | Quantum Grey       |      | R-TBHSQBGR0019  |         |
| TX / FX            | 300-350-450              | 2023           | Limited Edition<br>OEM | White/HSQ Blue     |      | R-TBHSQBMBL23   | € 29,95 |
|                    |                          |                |                        | White/Black        |      | R-TBHSQBMBL23   |         |
|                    |                          |                |                        | Black              |      | R-TBHSQBMR0023  |         |
|                    |                          |                |                        | White              |      | R-TBHSQBMBL0023 |         |
|                    |                          |                |                        | HSQ Yellow/Black   |      | R-TBHSQBQNR23   |         |
|                    |                          |                |                        | Quantum Grey/Black |      | R-TBHSQBGRNR23  |         |
|                    |                          |                |                        | White              |      | R-TBHSQBMBL0014 |         |
|                    |                          |                |                        | Black              |      | R-TBHSQBMR0014  |         |
| FC                 | 250-350-450              | 2014-2015      | OEM                    | White              |      | R-TBHSQBMBL0016 | € 30,95 |
|                    |                          |                |                        | Black              |      | R-TBHSQBMR0016  |         |
|                    |                          |                |                        | Neon Yellow        |      | R-TBHSQBGF0016  |         |
|                    |                          |                |                        | Quantum Grey       |      | R-TBHSQBGR0016  |         |
|                    |                          |                |                        | White/HSQ Yellow   |      | R-TBHSQBNGQ19   |         |
| FC                 | 250-350-450              | 2016 > 2018    | OEM                    | White              |      | R-TBHSQBMBL0019 | € 36,95 |
|                    |                          |                |                        | Black              |      | R-TBHSQBMR0019  |         |
|                    |                          |                |                        | Neon Yellow        |      | R-TBHSQBGF0019  |         |
|                    |                          |                |                        | Quantum Grey       |      | R-TBHSQBGR0019  |         |
|                    |                          |                |                        | White/HSQ Yellow   |      | R-TBHSQBNGQ19   |         |
| FC                 | 250-450 Rockstar Edition | 2018 > 2022    | Limited Edition<br>OEM | White              |      | R-TBHSQBMBL0019 | € 29,95 |
|                    |                          |                |                        | Black              |      | R-TBHSQBMR0019  |         |
|                    |                          |                |                        | Neon Yellow        |      | R-TBHSQBGF0019  |         |
|                    |                          |                |                        | Quantum Grey       |      | R-TBHSQBGR0019  |         |
|                    |                          |                |                        | White/HSQ Blue     |      | R-TBHSQBMBL23   |         |
|                    |                          |                |                        | White/Black        |      | R-TBHSQBMBL23   |         |
|                    |                          |                |                        | Black              |      | R-TBHSQBMR0023  |         |
|                    |                          |                |                        | White              |      | R-TBHSQBMBL0023 |         |
| HSQ Yellow/Black   |                          | R-TBHSQBQNR23  |                        |                    |      |                 |         |
| Quantum Grey/Black |                          | R-TBHSQBGRNR23 |                        |                    |      |                 |         |

NEW

NEW

## HUSQVARNA FRONT NUMBER PLATE / TABELLA PORTANUMERO ANTERIORE



R-TBHSQB0016



R-TBHSQBNGQ19

**OEM** original color - fluorescent color

| MODEL              | CC            | YEAR        | NOTES            | COLOR            | CODE          | PRICE   |
|--------------------|---------------|-------------|------------------|------------------|---------------|---------|
| FS / FX            | 350-450       | 2017-2018   | OEM              | White            | R-TBHSQB0016  | € 34,95 |
|                    |               |             |                  | Black            | R-TBHSQNR0016 |         |
|                    |               |             |                  | Neon Yellow      | R-TBHSQGF0016 |         |
|                    |               |             |                  | Quantum Grey     | R-TBHSQGR0016 |         |
| FS                 | 450           | 2019 > 2022 | Limited Edition  | White/HSQ Yellow | R-TBHSQBNGQ19 | € 36,95 |
|                    |               |             | OEM              | White            | R-TBHSQB0019  |         |
|                    |               |             | Black            | R-TBHSQNR0019    |               |         |
|                    |               |             | Neon Yellow      | R-TBHSQGF0019    |               |         |
| FS                 | 450           | 2023        | Limited Edition  | Quantum Grey     | R-TBHSQGR0019 | € 29,95 |
|                    |               |             | OEM              | White/HSQ Blue   | R-TBHSQB0023  |         |
|                    |               |             | White/Black      | R-TBHSQBNNR23    |               |         |
|                    |               |             | Black            | R-TBHSQNR0023    |               |         |
|                    |               |             | White            | R-TBHSQB0023     |               |         |
|                    |               |             | HSQ Yellow/Black | R-TBHSQGNR23     |               |         |
| Quantum Grey/Black | R-TBHSQGRNR23 |             |                  |                  |               |         |

**NEW**

## HUSQVARNA FACTORY FRONT NUMBER PLATE / TABELLA PORTANUMERO ANTERIORE

**FACTORY EDITION**

Maggiore superficie di protezione rispetto agli originali.

Enhanced protection surface for a better protection



R-TBHSQB0093



R-TBHSQB0093

R-TBHSQGNR93



### AVAILABLE COLORS

- Black
- White-HSQ Yellow
- White
- Neon Yellow
- Quantum Grey

**OEM** original color - fluorescent color

| MODEL   | CC                       | YEAR | NOTES | COLOR              | CODE          | PRICE   |
|---------|--------------------------|------|-------|--------------------|---------------|---------|
| TC / FC | 125-250-300-350-450      | 2023 | OEM   | White/HSQ Blue     | R-TBHSQB0093  | € 29,95 |
|         |                          |      |       | White/Black        | R-TBHSQBNNR93 |         |
|         |                          |      |       | Black              | R-TBHSQNR0093 |         |
|         |                          |      |       | White              | R-TBHSQB0093  |         |
|         |                          |      |       | HSQ Yellow/Black   | R-TBHSQGNR93  |         |
|         |                          |      |       | Quantum Grey/Black | R-TBHSQGRNR93 |         |
| TX / FX | 300-350-450              | 2023 | OEM   | White/HSQ Blue     | R-TBHSQB0093  | € 29,95 |
|         |                          |      |       | White/Black        | R-TBHSQBNNR93 |         |
|         |                          |      |       | Black              | R-TBHSQNR0093 |         |
|         |                          |      |       | White              | R-TBHSQB0093  |         |
|         |                          |      |       | HSQ Yellow/Black   | R-TBHSQGNR93  |         |
|         |                          |      |       | Quantum Grey/Black | R-TBHSQGRNR93 |         |
| FC      | 250-450 Rockstar Edition | 2022 | OEM   | White/HSQ Blue     | R-TBHSQB0093  | € 29,95 |
|         |                          |      |       | White/Black        | R-TBHSQBNNR93 |         |
|         |                          |      |       | Black              | R-TBHSQNR0093 |         |
|         |                          |      |       | White              | R-TBHSQB0093  |         |
|         |                          |      |       | HSQ Yellow/Black   | R-TBHSQGNR93  |         |
|         |                          |      |       | Quantum Grey/Black | R-TBHSQGRNR93 |         |
| FS      | 450                      | 2023 | OEM   | White/HSQ Blue     | R-TBHSQB0093  | € 29,95 |
|         |                          |      |       | White/Black        | R-TBHSQBNNR93 |         |
|         |                          |      |       | Black              | R-TBHSQNR0093 |         |
|         |                          |      |       | White              | R-TBHSQB0093  |         |
|         |                          |      |       | HSQ Yellow/Black   | R-TBHSQGNR93  |         |
|         |                          |      |       | Quantum Grey/Black | R-TBHSQGRNR93 |         |

**NEW**

**FACTORY EDITION**

# HUSQVARNA FRONT HEADLIGHT / MASCHERINA PORTAFARO



## AVAILABLE COLORS



**OEM** original color - fluorescent color

| MODEL   | CC                      | YEAR        | NOTES | COLOR        | CODE | PRICE         |         |         |
|---------|-------------------------|-------------|-------|--------------|------|---------------|---------|---------|
| TX      | 125                     | 2017 > 2019 | OEM   | White        |      | R-MASKHSQB17  | € 29,95 |         |
|         |                         |             |       | Black        |      | R-MASKHSQNR17 |         |         |
|         |                         |             |       | Neon Yellow  |      | R-MASKHSQGF17 |         |         |
|         |                         |             |       | Quantum Grey |      | R-MASKHSQGR17 |         |         |
| TE / FE | 150-250-300-350-450-501 | 2017 > 2019 | OEM   | White        |      | R-MASKHSQB17  | € 29,95 |         |
|         |                         |             |       | Black        |      | R-MASKHSQNR17 |         |         |
|         |                         |             |       | Neon Yellow  |      | R-MASKHSQGF17 |         |         |
|         |                         |             |       | Quantum Grey |      | R-MASKHSQGR17 |         |         |
| TE / FE | 150-250-300-350-450-501 | 2020 > 2023 | OEM   | White        |      | R-MASKHSQB20  | € 29,95 |         |
|         |                         |             |       | Black        |      | R-MASKHSQNR20 |         |         |
|         |                         |             |       | Neon Yellow  |      | R-MASKHSQGF20 |         |         |
|         |                         |             |       | Quantum Grey |      | R-MASKHSQGR20 |         |         |
|         |                         |             |       | HSQ Yellow   |      | R-MASKHSQGQ2B |         | € 29,95 |
|         |                         |             |       | White        |      | R-MASKHSQB2B  |         |         |
|         |                         |             |       | Black        |      | R-MASKHSQNR2B |         |         |



| MODEL   | CC        | YEAR        | NOTES                                       | COLOR | CODE          | PRICE   |
|---------|-----------|-------------|---|-------|---------------|---------|
| TE / FE | 125 > 501 | 2014 > 2023 | Replacement Mounting Elastic Bands<br>2 pcs | Black | R-ELASTNR0020 | € 10,95 |

**NEON**



# HUSQVARNA RADIATOR LOUVERS / GRIGLIE RADIATORE

R-GRKTMGF0019

Perimeter frame box made by technopolymer.  
Cornice perimetrale scatolata in tecnopolimero.



Removable radiator louvers to clean the radiators without using tools.

Griglia removibile senza l'uso di attrezzi per pulizia radiatori.

Horizontal bottom radiator protection. Prevents the collision between pipe and radiator on 250/300 2st.

Protezione orizzontale vaschetta radiatore  
Previene il contatto tra il radiatore e la marmitta nei modelli 250/300 2 tempi.

OVERSIZE REINFORCED  
RINFORZATE MAGGIORATE



R-GRKTMNR0017



The additional reinforcing ribs and the extra perimetral hexagons on the back side grant an increased resistance in case of fall or hits.

Rinforzo perimetrale scatolato, preserva i radiatori in caso di impatto.

Total protection of the top and bottom part of the stock radiator, it fully covers the part that with the standard louver remains without a shield against ground and stones. It also avoid the contact with the shroud on the top to avoid the damaging of the aluminum by the plastic.

Maggiore copertura superiore ed inferiore a protezione della vaschetta radiatore.  
Evitano il contatto del convogliatore con la vaschetta nella zona superiore, ed il relativo danneggiamento.

## AVAILABLE COLORS

Black HSQ Yellow  
White Neon Yellow

OEM original color - ☀ fluorescent color

| MODEL   | CC                      | YEAR        | NOTES | COLOR       | CODE | PRICE         |
|---------|-------------------------|-------------|-------|-------------|------|---------------|
| TC      | 125                     | 2016 > 2018 | OEM   | White       | ☐    | R-GRKTMBN0017 |
|         |                         |             |       | Black       | ■    | R-GRKTMNR0017 |
|         |                         |             |       | Neon Yellow | ☀    | R-GRKTMGF0017 |
|         |                         |             |       | HSQ Yellow  | ☀    | R-GRKTMGQ0017 |
| TX      | 125-150                 | 2017 > 2019 | OEM   | White       | ☐    | R-GRKTMBN0017 |
|         |                         |             |       | Black       | ■    | R-GRKTMNR0017 |
|         |                         |             |       | Neon Yellow | ☀    | R-GRKTMGF0017 |
|         |                         |             |       | HSQ Yellow  | ☀    | R-GRKTMGQ0017 |
| TE / FE | 150-250-300-350-450-501 | 2017 > 2019 | OEM   | White       | ☐    | R-GRKTMBN0017 |
|         |                         |             |       | Black       | ■    | R-GRKTMNR0017 |
|         |                         |             |       | Neon Yellow | ☀    | R-GRKTMGF0017 |
|         |                         |             |       | HSQ Yellow  | ☀    | R-GRKTMGQ0017 |
| FC      | 250-350-450             | 2016 > 2018 | OEM   | White       | ☐    | R-GRKTMBN0017 |
|         |                         |             |       | Black       | ■    | R-GRKTMNR0017 |
|         |                         |             |       | Neon Yellow | ☀    | R-GRKTMGF0017 |
|         |                         |             |       | HSQ Yellow  | ☀    | R-GRKTMGQ0017 |
| FS      | 450                     | 2017-2018   | OEM   | White       | ☐    | R-GRKTMBN0017 |
|         |                         |             |       | Black       | ■    | R-GRKTMNR0017 |
|         |                         |             |       | Neon Yellow | ☀    | R-GRKTMGF0017 |
|         |                         |             |       | HSQ Yellow  | ☀    | R-GRKTMGQ0017 |
| TC / TX | 250-350                 | 2017-2018   | OEM   | White       | ☐    | R-GRKTMBN0017 |
|         |                         |             |       | Black       | ■    | R-GRKTMNR0017 |
|         |                         |             |       | Neon Yellow | ☀    | R-GRKTMGF0017 |
|         |                         |             |       | HSQ Yellow  | ☀    | R-GRKTMGQ0017 |
| FX      | 350-450                 | 2017-2018   | OEM   | White       | ☐    | R-GRKTMBN0017 |
|         |                         |             |       | Black       | ■    | R-GRKTMNR0017 |
|         |                         |             |       | Neon Yellow | ☀    | R-GRKTMGF0017 |
|         |                         |             |       | HSQ Yellow  | ☀    | R-GRKTMGQ0017 |



**OEM** original color - fluorescent color

| MODEL   | CC                      | YEAR        | NOTES | COLOR       | CODE          | PRICE   |
|---------|-------------------------|-------------|-------|-------------|---------------|---------|
| TC / FC | 125-250-350-450         | 2019 > 2023 | OEM   | Black       | R-GRKTMNR0019 | € 43,95 |
|         |                         |             |       | White       | R-GRKTMNB0019 |         |
|         |                         |             |       | HSQ Yellow  | R-GRKTMGQ0019 |         |
|         |                         |             |       | Neon Yellow | R-GRKTMGF0019 |         |
| FC      | 450 Rockstar Edition    | 2018 > 2022 | OEM   | Black       | R-GRKTMNR0019 | € 43,95 |
|         |                         |             |       | White       | R-GRKTMNB0019 |         |
|         |                         |             |       | HSQ Yellow  | R-GRKTMGQ0019 |         |
|         |                         |             |       | Neon Yellow | R-GRKTMGF0019 |         |
| TX / FX | 300-350-450             | 2019 > 2023 | OEM   | Black       | R-GRKTMNR0019 | € 43,95 |
|         |                         |             |       | White       | R-GRKTMNB0019 |         |
|         |                         |             |       | HSQ Yellow  | R-GRKTMGQ0019 |         |
|         |                         |             |       | Neon Yellow | R-GRKTMGF0019 |         |
| FS      | 450                     | 2019 > 2023 | OEM   | Black       | R-GRKTMNR0019 | € 43,95 |
|         |                         |             |       | White       | R-GRKTMNB0019 |         |
|         |                         |             |       | HSQ Yellow  | R-GRKTMGQ0019 |         |
|         |                         |             |       | Neon Yellow | R-GRKTMGF0019 |         |
| TE / FE | 150-250-300-350-450-501 | 2020 > 2023 | OEM   | Black       | R-GRKTMNR0019 | € 43,95 |
|         |                         |             |       | White       | R-GRKTMNB0019 |         |
|         |                         |             |       | HSQ Yellow  | R-GRKTMGQ0019 |         |
|         |                         |             |       | Neon Yellow | R-GRKTMGF0019 |         |

**NEON**

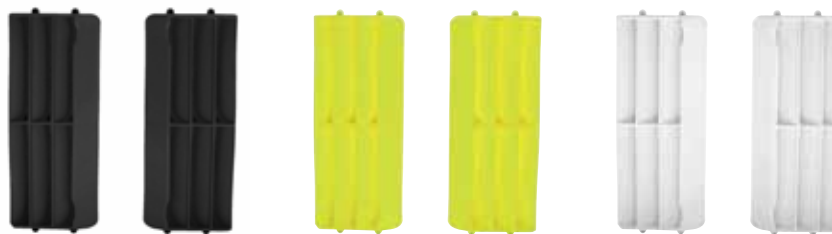

R-REPGRKTMNR9

R-REPGRKTMGF9

## AVAILABLE COLORS

- Black
- White
- HSQ Yellow
- Neon Yellow

**OEM** original color - fluorescent color

| MODEL   | CC                      | YEAR        | NOTES       | COLOR       | CODE          | PRICE   |
|---------|-------------------------|-------------|-------------|-------------|---------------|---------|
| TC / FC | 125-250-350-450         | 2019 > 2023 | OEM - 2 pcs | Black       | R-REPGRKTMNR9 | € 23,95 |
|         |                         |             |             | White       | R-REPGRKTMNB9 |         |
|         |                         |             |             | HSQ Yellow  | R-REPGRKTMGQ9 |         |
|         |                         |             |             | Neon Yellow | R-REPGRKTMGF9 |         |
| TX / FX | 300-350-450             | 2019 > 2023 | OEM - 2 pcs | Black       | R-REPGRKTMNR9 | € 23,95 |
|         |                         |             |             | White       | R-REPGRKTMNB9 |         |
|         |                         |             |             | HSQ Yellow  | R-REPGRKTMGQ9 |         |
|         |                         |             |             | Neon Yellow | R-REPGRKTMGF9 |         |
| FC      | 450 Rockstar Edition    | 2018 > 2022 | OEM - 2 pcs | Black       | R-REPGRKTMNR9 | € 23,95 |
|         |                         |             |             | White       | R-REPGRKTMNB9 |         |
|         |                         |             |             | HSQ Yellow  | R-REPGRKTMGQ9 |         |
|         |                         |             |             | Neon Yellow | R-REPGRKTMGF9 |         |
| FS      | 450                     | 2019 > 2023 | OEM - 2 pcs | Black       | R-REPGRKTMNR9 | € 23,95 |
|         |                         |             |             | White       | R-REPGRKTMNB9 |         |
|         |                         |             |             | HSQ Yellow  | R-REPGRKTMGQ9 |         |
|         |                         |             |             | Neon Yellow | R-REPGRKTMGF9 |         |
| TE / FE | 150-250-300-350-450-501 | 2020 > 2023 | OEM - 2 pcs | Black       | R-REPGRKTMNR9 | € 23,95 |
|         |                         |             |             | White       | R-REPGRKTMNB9 |         |
|         |                         |             |             | HSQ Yellow  | R-REPGRKTMGQ9 |         |
|         |                         |             |             | Neon Yellow | R-REPGRKTMGF9 |         |

## HUSQVARNA REAR SHOCK MUD FLAP / PARASPRUZZI MONOAMMORTIZZATORE



R-PSPKTMNR007



R-PSPKTMNR016

### AVAILABLE COLORS

Black

OEM original color

| MODEL   | CC                       | YEAR        | NOTES | COLOR | CODE          | PRICE   |
|---------|--------------------------|-------------|-------|-------|---------------|---------|
| TC      | 65                       | 2017 > 2023 |       | Black | R-PSPKTMNR165 | € 18,95 |
| TC      | 85                       | 2014 > 2016 |       | Black | R-PSPKTMNR985 | € 14,95 |
| TC      | 85                       | 2018 > 2023 |       | Black | R-PSPKTMNR185 | € 14,95 |
| TC / TE | 449-511                  | 2011 > 2013 |       | Black | R-PSPHSQNR011 | € 25,95 |
| TC      | 125                      | 2014-2015   |       | Black | R-PSPKTMNR007 | € 14,95 |
| TC      | 125                      | 2016 > 2022 |       | Black | R-PSPKTMNR016 | € 14,95 |
| TC / FC | 125-250-300-350-450      | 2023        |       | Black | R-PSPKTMNR023 | € 12,95 |
| TC      | 250                      | 2014 > 2016 |       | Black | R-PSPKTMNR007 | € 14,95 |
| TE / FE | 125-250-300-350-450-501  | 2014 > 2016 |       | Black | R-PSPKTMNR007 | € 14,95 |
| FC      | 250-350-450              | 2014-2015   |       | Black | R-PSPKTMNR007 | € 14,95 |
| TC / TX | 125-250-300              | 2017 > 2022 |       | Black | R-PSPKTMNR016 | € 14,95 |
| FC      | 250-350-450              | 2016 > 2022 |       | Black | R-PSPKTMNR016 | € 14,95 |
| FC      | 250-450 Rockstar Edition | 2022        |       | Black | R-PSPKTMNR023 | € 12,95 |
| FS/FX   | 250-350-450              | 2016 > 2022 |       | Black | R-PSPKTMNR016 | € 14,95 |
| TX / FX | 300-350-450              | 2023        |       | Black | R-PSPKTMNR023 | € 12,95 |
| TE/FE   | 125-150-250-300-350-450  | 2016 > 2023 |       | Black | R-PSPKTMNR016 | € 14,95 |
| FS      | 450                      | 2023        |       | Black | R-PSPKTMNR023 | € 12,95 |

NEW

## HUSQVARNA FRONT FENDER BRACE / RINFORZO PARAFANGO ANTERIORE



R-SPHSQNR0005

### AVAILABLE COLORS

Black

OEM original color

| MODEL   | CC      | YEAR        | NOTES | COLOR | CODE          | PRICE   |
|---------|---------|-------------|-------|-------|---------------|---------|
| CR / WR | 125-250 | 2006 > 2013 | OEM   | Black | R-SPHSQNR0005 | € 22,95 |
| TC / TE | 250-310 | 2005 > 2013 |       | Black | R-SPHSQNR0005 | € 22,95 |
| TC / TE | 450-510 | 2005 > 2010 |       | Black | R-SPHSQNR0005 | € 22,95 |

## HUSQVARNA CHAIN SLIDER / SLITTA SCORRICATENA FORCELLONE



R-SLIKTMR085



R-SLIKTMR011

### AVAILABLE COLORS

Black

HSQ Blue

OEM original color

| MODEL          | CC                          | YEAR        | NOTES | COLOR    | CODE           | PRICE   |
|----------------|-----------------------------|-------------|-------|----------|----------------|---------|
| TC             | 65                          | 2017 > 2023 | OEM   | Black    | R-SLIKTMR165   | € 25,95 |
| TC             | 85                          | 2014        | OEM   | Black    | R-SLIKTMR085   | € 25,95 |
| TC             | 85                          | 2015 > 2023 | OEM   | Black    | R-SLIKTMR185   | € 25,95 |
| TC/FC/TX/FS/FX | 125-150-250-300-350-450-501 | 2014 > 2022 | OEM   | Black    | R-SLIKTMR011   | € 25,95 |
| FC             | 250-450 Rockstar Edition    | 2022        |       | HSQ Blue | R-SLIKTMBLH011 |         |
| FC             | 250-450 Rockstar Edition    | 2022        |       | Black    | R-SLIKTMR023   | € 22,95 |
| TX / FX        | 300-350-450                 | 2023        |       | Black    | R-SLIKTMR023   | € 22,95 |
| TC / FC        | 125-250-300-350-450         | 2023        |       | Black    | R-SLIKTMR023   | € 22,95 |
| TE/FE          | 125-150-250-300-350-450-501 | 2014 > 2023 | OEM   | Black    | R-SLIKTMR011   | € 25,95 |
| FS             | 450                         | 2023        |       | HSQ Blue | R-SLIKTMBLH011 |         |
| FS             | 450                         | 2023        |       | Black    | R-SLIKTMR023   | € 22,95 |

NEW

# HUSQVARNA CHAIN PAD / PATTINO SCORRICATENA



## AVAILABLE COLORS

PATTKTMNR16

OEM original color

| MODEL   | CC                       | YEAR        | NOTES | COLOR    | CODE           | PRICE  |
|---------|--------------------------|-------------|-------|----------|----------------|--------|
| TC      | 65                       | 2017 > 2023 | OEM   | Black    | R-PATTKTMNR01  | € 9,95 |
| TC      | 85                       | 2018 > 2023 | OEM   | Black    | R-PATTKTMNR11  | € 9,95 |
|         |                          |             |       | HSQ Blue | R-PATTKTMBLH11 |        |
| TC      | 125                      | 2014-2015   | OEM   | Black    | R-PATTKTMNR11  | € 9,95 |
|         |                          |             |       | HSQ Blue | R-PATTKTMBLH11 |        |
| TC      | 125                      | 2016 > 2022 | OEM   | Black    | R-PATTKTMNR16  | € 9,95 |
| TC      | 250                      | 2014 > 2016 | OEM   | Black    | R-PATTKTMNR11  | € 9,95 |
|         |                          |             |       | HSQ Blue | R-PATTKTMBLH11 |        |
| TX      | 125-150-250-300          | 2017 > 2022 | OEM   | Black    | R-PATTKTMNR16  | € 9,95 |
| TX      | 250-300                  | 2017 > 2022 | OEM   | Black    | R-PATTKTMNR16  | € 9,95 |
| FC      | 250-350-450              | 2014-2015   | OEM   | Black    | R-PATTKTMNR11  | € 9,95 |
|         |                          |             |       | HSQ Blue | R-PATTKTMBLH11 |        |
| FC      | 250-350-450              | 2016 > 2022 |       | Black    | R-PATTKTMNR16  | € 9,95 |
| FC      | 250-450 Rockstar Edition | 2022        |       | Black    | R-PATTKTMNR23  | € 8,95 |
| TC / FC | 125-250-300-350-450      | 2023        |       | Black    | R-PATTKTMNR23  | € 8,95 |
| TE / FE | 125-250-300-350-450-501  | 2014 > 2016 | OEM   | Black    | R-PATTKTMNR11  | € 9,95 |
|         |                          |             |       | HSQ Blue | R-PATTKTMBLH11 |        |
| FS/FX   | 125-150-250-300-350-450  | 2017 > 2022 | OEM   | Black    | R-PATTKTMNR16  | € 9,95 |
| TX / FX | 300-350-450              | 2023        |       | Black    | R-PATTKTMNR23  | € 8,95 |
| TE/FE   | 125-150-250-300-350-450  | 2017 > 2023 | OEM   | Black    | R-PATTKTMNR16  | € 9,95 |
| FS      | 450                      | 2023        |       | Black    | R-PATTKTMNR23  | € 8,95 |



# HUSQVARNA CHAIN GUIDE / CRUNA GUIDA CATENA



R-CRUKTMNRNT14



R-CRUKTMNRBLH14

## AVAILABLE COLORS

Black Black-Neutral Black-HSQ Blue

OEM original color

| MODEL        | CC                          | YEAR        | NOTES                     | COLOR          | CODE            | PRICE   |
|--------------|-----------------------------|-------------|---------------------------|----------------|-----------------|---------|
| TC           | 65                          | 2017 > 2023 | OEM                       | Black          | R-CRUKTMNR165   | € 25,95 |
| TC           | 85                          | 2014        | OEM                       | Black          | R-CRUKTMNR000   | € 25,95 |
| TC           | 85                          | 2015 > 2023 | OEM - Bi-Material         | Black-Neutral  | R-CRUKTMNRNT14  | € 38,95 |
|              |                             |             | Bi-Material               | Black-HSQ Blue | R-CRUKTMNRBLH14 |         |
| TC / FC      | 125-250-350-450             | 2015 > 2022 | OEM - Aluminum reinforced | Black          | R-CRUKTMNR016   | € 38,95 |
| TC / FC      | 125-250-300-350-450         | 2023        | OEM                       | Black          | R-CRUKTMNR023   | € 34,95 |
| FC           | 250-450 Rockstar Edition    | 2022        | OEM                       | Black          | R-CRUKTMNR023   | € 34,95 |
| TE / FE      | 125-150-250-300-350-450-501 | 2014 > 2023 | Bi-Material               | Black-HSQ Blue | R-CRUKTMNRBLH14 | € 38,95 |
|              |                             |             | OEM - Bi-Material         | Black-Neutral  | R-CRUKTMNRNT14  |         |
| TX           | 125-150                     | 2017 > 2022 | Bi-Material               | Black-HSQ Blue | R-CRUKTMNRBLH14 | € 38,95 |
|              |                             |             | OEM - Bi-Material         | Black-Neutral  | R-CRUKTMNRNT14  |         |
| TX / FX / FS | 300-350-450                 | 2017 > 2022 | Aluminum reinforced       | Black          | R-CRUKTMNR016   | € 38,95 |
| TX / FX      | 300-350-450                 | 2023        | OEM                       | Black          | R-CRUKTMNR023   | € 34,95 |
| FS           | 450                         | 2023        | OEM                       | Black          | R-CRUKTMNR023   | € 34,95 |



MONOBLOCK R2.0 WORX  
CHAIN GUIDE  
PAG. 254

# HUSQVARNA REPLICA PLASTICS KIT / KIT PLASTICHE REPLICA



R-KITHSQ-OEM-520

**OEM** original color - fluorescent color

















































































































| MODEL                                       | CC              | YEAR         | NOTES  | COLOR              |  |  |  |  |                  |                  | CODE             | PRICE            |          |
|---|-----------------|--------------|--|--------------------|--|--|--|--|------------------|------------------|------------------|------------------|----------|
| TC  | 65              | 2017 > 2023  | OEM 2017 > 2022<br>OEM 2023  | White              |  |  |  |  |                  |                  | R-KITHSQ-BNO-565 | € 134,95         |          |
|   |                 |              |  | OEM                |  |  |  |  |                  |                  | R-KITHSQ-OEM-565 |                  |          |
|   |                 |              |  | Black              |  |  |  |  |                  |                  | R-KITHSQ-NR0-565 |                  |          |
| TC  | 85              | 2014 > 2017  | OEM 2016<br>OEM 2014-2015 and 2017   | Neon Yellow        |  |  |  |  |                  |                  | R-KITHSQ-GF0-565 |                  |          |
|   |                 |              |  | OEM                |  |  |  |  |                  |                  |                  | R-KITHSQ-OEM-519 | € 134,95 |
|   |                 |              |  | OEM                |  |  |  |  |                  |                  |                  | R-KITHSQ-OEM-509 |          |
| TC  | 85              | 2018 > 2023  | OEM 2018 > 2022<br>OEM 2023  | Black              |  |  |  |  |                  |                  | R-KITHSQ-NR0-509 |                  |          |
|   |                 |              |  | White              |  |  |  |  |                  |                  |                  | R-KITHSQ-OEM-585 | € 134,95 |
|   |                 |              |  | OEM                |  |  |  |  |                  |                  |                  | R-KITHSQ-OEM-586 |          |
| TC  | 85              | 2018 > 2023  | OEM 2018 > 2022<br>OEM 2023  | Black              |  |  |  |  |                  |                  | R-KITHSQ-NR0-585 |                  |          |
|   |                 |              |  | Neon Yellow        |  |  |  |  |                  |                  |                  | R-KITHSQ-GF0-585 |          |
|   |                 |              |  | OEM                |  |  |  |  |                  |                  |                  | R-KITHSQ-OEM-401 | € 124,95 |
| WR  | 125             | 2006 > 2008  | OEM  | OEM                |  |  |  |  |                  | R-KITHSQ-OEM-405 | € 124,95         |                  |          |
| WR  | 125             | 2009 > 2013  | OEM  | OEM                |  |  |  |  |                  | R-KITHSQ-NR0-405 |                  |                  |          |
| WR  | 250-300         | 2006 > 2013  | OEM  | OEM                |  |  |  |  |                  | R-KITHSQ-OEM-401 | € 124,95         |                  |          |
| TE  | 250-310-450-510 | 2005 > 2007  | OEM  | OEM                |  |  |  |  |                  | R-KITHSQ-OEM-401 | € 124,95         |                  |          |
| TE  | 450-510         | 2008 > 2010  | OEM - Rear fender without tail light<br>Rear fender without tail light<br>Rear fender without tail light | OEM                |  |  |  |  |                  |                  | R-KITHSQ-OEM-402 | € 124,95         |          |
|   |                 |              |  | White              |  |  |  |  |                  |                  |                  | R-KITHSQ-BNO-402 |          |
|   |                 |              |  | Black              |  |  |  |  |                  |                  |                  | R-KITHSQ-NR0-402 |          |
| TE  | 250             | 2008-2009    | OEM - Rear fender without tail light<br>Rear fender without tail light<br>Rear fender without tail light | OEM                |  |  |  |  |                  |                  | R-KITHSQ-OEM-402 | € 124,95         |          |
|   |                 |              |  | White              |  |  |  |  |                  |                  |                  | R-KITHSQ-BNO-402 |          |
|   |                 |              |  | Black              |  |  |  |  |                  |                  |                  | R-KITHSQ-NR0-402 |          |
| TE  | 250             | 2010 > 2013  | OEM - Rear fender without tail light<br>Rear fender without tail light<br>Rear fender without tail light | OEM                |  |  |  |  |                  |                  | R-KITHSQ-OEM-406 | € 124,95         |          |
|   |                 |              |  | Black              |  |  |  |  |                  |                  |                  | R-KITHSQ-NR0-406 |          |
|   |                 |              |  | OEM                |  |  |  |  |                  |                  |                  | R-KITHSQ-OEM-402 | € 124,95 |
| TE  | 310             | 2008 > 2010  | OEM - Rear fender without tail light<br>Rear fender without tail light<br>Rear fender without tail light | OEM                |  |  |  |  |                  |                  | R-KITHSQ-OEM-402 | € 124,95         |          |
|   |                 |              |  | White              |  |  |  |  |                  |                  |                  | R-KITHSQ-BNO-402 |          |
|   |                 |              |  | Black              |  |  |  |  |                  |                  |                  | R-KITHSQ-NR0-402 |          |
| TE  | 310             | 2011 > 2013  | OEM - Rear fender without tail light<br>Rear fender without tail light<br>Rear fender without tail light | OEM                |  |  |  |  |                  |                  | R-KITHSQ-OEM-406 | € 124,95         |          |
|   |                 |              |  | Black              |  |  |  |  |                  |                  |                  | R-KITHSQ-NR0-406 |          |
|   |                 |              |  | OEM                |  |  |  |  |                  |                  |                  | R-KITHSQ-OEM-507 | € 199,95 |
| TC  | 449-511         | 2011 > 2013  | OEM  | OEM                |  |  |  |  |                  | R-KITHSQ-OEM-407 | € 194,95         |                  |          |
| TE  | 449-511         | 2011 > 2013  | OEM  | OEM                |  |  |  |  |                  | R-KITHSQ-OEM-407 | € 194,95         |                  |          |
| TC / FC<br>kit includes vented front fender | 125-250-350-450 | 2014-2015    | OEM 2015<br>OEM 2014   | White-HSQ Blue     |  |  |  |  |                  |                  | R-KITHSQ-OEM-588 | € 134,95         |          |
|   |                 |              |  | White-Black        |  |  |  |  |                  |                  |                  | R-KITHSQ-OEM-508 |          |
|   |                 |              |  | White-Yellow       |  |  |  |  |                  |                  |                  | R-KITHSQ-OEM-598 |          |
|   |                 |              |  | Black              |  |  |  |  |                  |                  |                  | R-KITHSQ-NR0-508 |          |
|   |                 |              |  | White-HSQ Blue     |  |  |  |  |                  |                  |                  | R-KITHSQ-OEM-516 | € 159,95 |
| TC<br>kit includes vented front fender      | 125             | 2016 > 2018  | OEM 2016<br>OEM 2017-2018  | White              |  |  |  |  |                  |                  | R-KITHSQ-BNO-516 |                  |          |
|   |                 |              |  | Black              |  |  |  |  |                  |                  |                  | R-KITHSQ-NR0-516 |          |
|   |                 |              |  | Neon Yellow        |  |  |  |  |                  |                  |                  | R-KITHSQ-GF0-516 |          |
|   |                 |              |  | HSQ Red-White      |  |  |  |  |                  |                  |                  | R-KITHSQ-RQ0-516 |          |
|   |                 |              |  | Quantum Grey       |  |  |  |  |                  |                  |                  | R-KITHSQ-GR0-516 |          |
| TC / FC<br>kit includes vented front fender | 125-250-350-450 | 2019 > 2022  | OEM 2020-2021<br>OEM 2019 and 2022   | White-Yellow-Grey  |  |  |  |  |                  |                  | R-KITHSQ-OEM-529 | € 159,95         |          |
|   |                 |              |  | White-Yellow       |  |  |  |  |                  |                  |                  | R-KITHSQ-OEM-599 | € 159,95 |
|   |                 |              |  | White              |  |  |  |  |                  |                  |                  | R-KITHSQ-BNO-599 | € 159,95 |
|   |                 |              |  | Black              |  |  |  |  |                  |                  |                  | R-KITHSQ-NR0-599 | € 159,95 |
|   |                 |              |  | Neon Yellow        |  |  |  |  |                  |                  |                  | R-KITHSQ-GF0-599 | € 159,95 |
|   |                 |              |  | Quantum Grey       |  |  |  |  |                  |                  |                  | R-KITHSQ-GR0-599 | € 159,95 |
|   |                 |              |  | White-Yellow-Black |  |  |  |  |                  |                  |                  | R-KITHSQ-GQ0-599 | € 159,95 |
| With blue fork protectors                   |                 | White-Yellow |  |                    |  |  |  |  | R-KITHSQ-OEM-609 | € 172,95         |                  |                  |          |

**OEM** original color -  fluorescent color

| MODEL  | CC                      | YEAR        | NOTES  | COLOR              |  |  |  |  |  |  | CODE             | PRICE            |                  |                  |          |
|--|-------------------------|-------------|--|--------------------|--|--|--|--|--|--|------------------|------------------|------------------|------------------|----------|
| <b>TC</b><br>kit includes vented front fender      | 250                     | 2014 > 2016 | OEM 2016<br>OEM 2015<br>OEM 2014                       | White-HSQ Blue     |  |  |  |  |  |  | R-KITHSQ-OEM-588 | € 134,95         |                  |                  |          |
|  |                         |             |  | White-Yellow       |  |  |  |  |  |  |                  | R-KITHSQ-OEM-598 |                  |                  |          |
|  |                         |             |  | White-Black        |  |  |  |  |  |  |                  |                  | R-KITHSQ-OEM-508 |                  |          |
|  |                         |             |  | Black              |  |  |  |  |  |  |                  |                  | R-KITHSQ-NR0-508 |                  |          |
| <b>TC / TX</b><br>kit includes vented front fender | 250-300                 | 2017-2018   | OEM 2017-2018<br>OEM 2016                              | White              |  |  |  |  |  |  | R-KITHSQ-BN0-516 | € 159,95         |                  |                  |          |
|  |                         |             |  | White-Blue         |  |  |  |  |  |  |                  |                  | R-KITHSQ-OEM-516 |                  |          |
|  |                         |             |  | Black              |  |  |  |  |  |  |                  |                  | R-KITHSQ-NR0-516 |                  |          |
|  |                         |             |  | ☀ Neon Yellow      |  |  |  |  |  |  |                  |                  |                  | R-KITHSQ-GF0-516 |          |
|  |                         |             |  | HSQ Red-White      |  |  |  |  |  |  |                  |                  |                  | R-KITHSQ-RQ0-516 |          |
|  |                         |             |  | Quantum Grey       |  |  |  |  |  |  |                  |                  |                  | R-KITHSQ-GR0-516 |          |
| <b>TE / FE</b><br>kit includes vented front fender | 125-250-300-350-450-501 | 2014        | OEM 2014   | White-Black        |  |  |  |  |  |  | R-KITHSQ-OEM-410 | € 124,95         |                  |                  |          |
|  |                         |             |  | Black              |  |  |  |  |  |  |                  |                  | R-KITHSQ-NR0-410 |                  |          |
| <b>TE / FE</b><br>kit includes vented front fender | 125-250-300-350-450-501 | 2015-2016   | OEM 2016<br>OEM 2015                                   | White-HSQ Blue     |  |  |  |  |  |  | R-KITHSQ-OEM-416 | € 124,95         |                  |                  |          |
|  |                         |             |  | White-Yellow       |  |  |  |  |  |  |                  |                  | R-KITHSQ-OEM-411 |                  |          |
|  |                         |             |  | Black              |  |  |  |  |  |  |                  |                  | R-KITHSQ-NR0-411 |                  |          |
| <b>TE / FE</b><br>kit includes vented front fender | 150-250-300-350-450-501 | 2017-2019   | OEM 2019<br>OEM 2017-2019                              | White              |  |  |  |  |  |  | R-KITHSQ-OEM-417 | € 147,95         |                  |                  |          |
|  |                         |             |  | White-HSQ Blue     |  |  |  |  |  |  |                  |                  | R-KITHSQ-OEM-417 |                  |          |
|  |                         |             |  | Black              |  |  |  |  |  |  |                  |                  | R-KITHSQ-NR0-417 |                  |          |
|  |                         |             |  | ☀ Neon Yellow      |  |  |  |  |  |  |                  |                  |                  | R-KITHSQ-GF0-417 |          |
|  |                         |             |  | HSQ Red-White      |  |  |  |  |  |  |                  |                  |                  | R-KITHSQ-RQ0-417 |          |
|  |                         |             |  | Quantum Grey       |  |  |  |  |  |  |                  |                  |                  | R-KITHSQ-GR0-417 |          |
| <b>TE / FE</b><br>kit includes vented front fender | 150-250-300-350-450-501 | 2017-2019   | OEM 2019-WHITE HEADLIGHT PLASTIC<br>OEM 2017-2018      | White              |  |  |  |  |  |  | R-KITHSQ-BN0-517 | € 159,95         |                  |                  |          |
|  |                         |             |  | White-HSQ Blue     |  |  |  |  |  |  |                  |                  | R-KITHSQ-OEM-517 |                  |          |
|  |                         |             |  | Black              |  |  |  |  |  |  |                  |                  | R-KITHSQ-NR0-517 |                  |          |
|  |                         |             |  | ☀ Neon Yellow      |  |  |  |  |  |  |                  |                  |                  | R-KITHSQ-GF0-517 |          |
|  |                         |             |  | HSQ Red-White      |  |  |  |  |  |  |                  |                  |                  | R-KITHSQ-RQ0-517 |          |
|  |                         |             |  | Quantum Grey       |  |  |  |  |  |  |                  |                  |                  | R-KITHSQ-GR0-517 |          |
| <b>TX</b><br>kit includes vented front fender      | 125-150                 | 2017-2019   | OEM 2017-2019  | White              |  |  |  |  |  |  | R-KITHSQ-OEM-417 | € 147,95         |                  |                  |          |
|  |                         |             |  | White-HSQ Blue     |  |  |  |  |  |  |                  |                  | R-KITHSQ-BN0-417 |                  |          |
|  |                         |             |  | Black              |  |  |  |  |  |  |                  |                  | R-KITHSQ-NR0-417 |                  |          |
|  |                         |             |  | ☀ Neon Yellow      |  |  |  |  |  |  |                  |                  |                  | R-KITHSQ-GF0-417 |          |
|  |                         |             |  | HSQ Red-White      |  |  |  |  |  |  |                  |                  |                  | R-KITHSQ-RQ0-417 |          |
| <b>TX</b><br>kit includes vented front fender      | 125-150                 | 2017-2019   | OEM 2019-WHITE HEADLIGHT PLASTIC<br>OEM 2017-2018      | White              |  |  |  |  |  |  | R-KITHSQ-BN0-517 | € 159,95         |                  |                  |          |
|  |                         |             |  | White-HSQ Blue     |  |  |  |  |  |  |                  |                  | R-KITHSQ-OEM-517 |                  |          |
|  |                         |             |  | Black              |  |  |  |  |  |  |                  |                  | R-KITHSQ-NR0-517 |                  |          |
|  |                         |             |  | ☀ Neon Yellow      |  |  |  |  |  |  |                  |                  |                  | R-KITHSQ-GF0-517 |          |
|  |                         |             |  | HSQ Red-White      |  |  |  |  |  |  |                  |                  |                  | R-KITHSQ-RQ0-517 |          |
|  |                         |             |  | Quantum Grey       |  |  |  |  |  |  |                  |                  |                  | R-KITHSQ-GR0-517 |          |
| <b>TX / FX</b><br>kit includes vented front fender | 300-350-450             | 2019 > 2022 | OEM 2020-2021<br>OEM 2019                              | White-Yellow-Grey  |  |  |  |  |  |  | R-KITHSQ-OEM-529 | € 159,95         |                  |                  |          |
|  |                         |             |  | White-Yellow       |  |  |  |  |  |  |                  |                  | R-KITHSQ-OEM-599 | € 159,95         |          |
|  |                         |             |  | White              |  |  |  |  |  |  |                  |                  | R-KITHSQ-BN0-599 | € 159,95         |          |
|  |                         |             |  | Black              |  |  |  |  |  |  |                  |                  | R-KITHSQ-NR0-599 | € 159,95         |          |
|  |                         |             |  | ☀ Neon Yellow      |  |  |  |  |  |  |                  |                  |                  | R-KITHSQ-GF0-599 | € 159,95 |
|  |                         |             |  | Quantum Grey       |  |  |  |  |  |  |                  |                  |                  | R-KITHSQ-GR0-599 | € 159,95 |
|  |                         |             |  | White-Yellow-Black |  |  |  |  |  |  |                  |                  |                  | R-KITHSQ-GQ0-599 | € 159,95 |
| <b>FC</b><br>kit includes vented front fender      | 250-350-450             | 2016 > 2018 | With blue fork protectors<br>OEM 2017-2018<br>OEM 2016 | White-Yellow       |  |  |  |  |  |  | R-KITHSQ-OEM-609 | € 172,95         |                  |                  |          |
|  |                         |             |  | White              |  |  |  |  |  |  |                  |                  | R-KITHSQ-BN0-516 | € 159,95         |          |
|  |                         |             |  | White-HSQ Blue     |  |  |  |  |  |  |                  |                  | R-KITHSQ-OEM-516 |                  |          |
|  |                         |             |  | Black              |  |  |  |  |  |  |                  |                  | R-KITHSQ-NR0-516 |                  |          |
|  |                         |             |  | ☀ Neon Yellow      |  |  |  |  |  |  |                  |                  |                  | R-KITHSQ-GF0-516 |          |
|  |                         |             |  | HSQ Red-White      |  |  |  |  |  |  |                  |                  |                  | R-KITHSQ-RQ0-516 |          |
|  |                         |             |  | Quantum Grey       |  |  |  |  |  |  |                  |                  |                  | R-KITHSQ-GR0-516 |          |
|  |                         |             |  | White-Yellow-Grey  |  |  |  |  |  |  |                  |                  |                  | R-KITHSQ-OEM-529 | € 159,95 |
| <b>FC</b><br>kit includes vented front fender      | 450 Rockstar Edition    | 2018 > 2022 | OEM Rockstar Edition 2021<br>With blue fork protectors | White-HSQ Yellow   |  |  |  |  |  |  | R-KITHSQ-OEM-599 | € 159,95         |                  |                  |          |
|  |                         |             |  | White              |  |  |  |  |  |  |                  |                  | R-KITHSQ-BN0-599 | € 159,95         |          |
|  |                         |             |  | Black              |  |  |  |  |  |  |                  |                  | R-KITHSQ-NR0-599 | € 159,95         |          |
|  |                         |             |  | ☀ Neon Yellow      |  |  |  |  |  |  |                  |                  |                  | R-KITHSQ-GF0-599 | € 159,95 |
|  |                         |             |  | Quantum Grey       |  |  |  |  |  |  |                  |                  |                  | R-KITHSQ-GR0-599 | € 159,95 |
|  |                         |             |  | White-Yellow-Black |  |  |  |  |  |  |                  |                  |                  | R-KITHSQ-GQ0-599 | € 159,95 |
|  |                         |             |  | White-Yellow       |  |  |  |  |  |  |                  |                  |                  | R-KITHSQ-OEM-609 | € 172,95 |
|  |                         |             |  | White              |  |  |  |  |  |  |                  |                  |                  | R-KITHSQ-BN0-516 | € 159,95 |
| <b>FS / FX</b><br>kit includes vented front fender | 350-450                 | 2017-2018   | OEM 2017-2018<br>OEM 2016                              | White-HSQ Blue     |  |  |  |  |  |  | R-KITHSQ-OEM-516 |                  |                  |                  |          |
|  |                         |             |  | Black              |  |  |  |  |  |  |                  |                  | R-KITHSQ-NR0-516 |                  |          |
|  |                         |             |  | ☀ Neon Yellow      |  |  |  |  |  |  |                  |                  |                  | R-KITHSQ-GF0-516 |          |
|  |                         |             |  | HSQ Red-White      |  |  |  |  |  |  |                  |                  |                  | R-KITHSQ-RQ0-516 |          |
|  |                         |             |  | Quantum Grey       |  |  |  |  |  |  |                  |                  |                  | R-KITHSQ-GR0-516 |          |

# HUSQVARNA REPLICA PLASTICS KIT / KIT PLASTICHE REPLICA

OEM original color -  fluorescent color

| MODEL                                       | CC  | YEAR        | NOTES                      | COLOR   |   |  |   |   |   |   | CODE  | PRICE   |   |                  |          |
|---|---|-------------|----------------------------|---|---|--|---|---|---|---|---|---|---|------------------|----------|
| TE / FE<br>kit includes vented front fender | 150-250-300-350-450-501   | 2020 > 2023 | OEM 2020-2021              | White/Anthracite Grey   |  |  |  |  |  |  | R-KITHSQ-OEM-420  | € 147,95  |   |                  |          |
|   |   |             | OEM 2022                   | White   |  |  |  |  |  |  |  | R-KITHSQ-BN0-420  | € 147,95  |                  |          |
|   |   |             | OEM 2023                   | White-Yellow  |  |  |  |  |  |  |  |  | R-KITHSQ-OEM-423  | € 147,95         |          |
|   |   |             |                            | Black   |  |  |  |  |  |  |  |  | R-KITHSQ-NR0-420  | € 147,95         |          |
|   |   |             |                            | White-Yellow-Black  |  |  |  |  |  |  |  |  | R-KITHSQ-GQ0-420  | € 147,95         |          |
|   |   |             |                            | OEM 2020-2021   | White/Anthracite Grey   |   |   |  |  |  |  |  |  | R-KITHSQ-OEM-520 | € 159,95 |
|   |   |             |                            | OEM 2022  | White   |   |   |  |  |  |  |  |  | R-KITHSQ-BN0-520 | € 159,95 |
|   |   |             |                            | OEM 2023  | White-Yellow  |   |   |  |  |  |  |  |  | R-KITHSQ-OEM-521 | € 159,95 |
|   |   |             |                            |   | Black   |   |   |  |  |  |  |  |  | R-KITHSQ-NR0-520 | € 159,95 |
|   |   |             |                            |   | Neon Yellow   |   |   |  |  |  |  |  |  | R-KITHSQ-GF0-520 | € 159,95 |
|   |   |             |                            |   | Quantum Grey  |   |   |  |  |  |  |  |  | R-KITHSQ-GR0-520 | € 159,95 |
|   |   |             | With grey fork protectors  |   |   | OEM 2022   | White   |    |   |  |  |  |  | R-KITHSQ-BN0-620 | € 172,95 |
|   |   |             | With white fork protectors |  |   | OEM Rockstar Edition 2021  | White-Black   |    |   |  |  |  |  | R-KITHSQ-NR0-620 | € 172,95 |
|   |   |             | With white fork protectors |  |   | OEM 2023   | White-Yellow  |    |   |  |  |  |  | R-KITHSQ-OEM-621 | € 172,95 |
| With white fork protectors                  |  |             | OEM Rockstar Edition 2022  | White-Black   |  |  |  |  |  |  | R-KITHSQ-OEM-623  | € 172,95  |   |                  |          |



R-KITHSQ-GF0-517





**PVI**  
S.p.A.  
LAVORAZIONI MECCANICHE

ITALIA

**2**

ADAMO Andrea

**FERVAL**  
TOOLS AND TOOL KITS

**Wossner**  
Manufacturer of forged pistons

**VIGNOLCARRAI**  
MECCANICHE CARBURI E COMPONENTI DEL MOTORE

**ETRIKO**

**YUASA**

**ACTIVE**

**XACT**

Twin Air

**WIP**  
wipracing.com

**TYSON**

**XTRIG**

**ROCK**

**XTRIG**

**ROCK**

**WIP**

**WIP**

**WIP**

**WIP**

## **GAS GAS**

- Front fender** / Parafango anteriore >pag 222
- Rear fender** / Parafango posteriore >pag 222
- Radiator shrouds** / Convogliatori aria radiatore >pag 223
- Side panels** / Tabelle laterali portanumero >pag 223
- Air box covers** / Coperchi laterali cassa filtro >pag 224
- Oversize radiator louvers** / Griglie radiatore maggiorate >pag 224
- Front number plate** / Tabella portanumero anteriore >pag 225
- Front headlight** / Mascherina portafaro >pag 225
- Chain guide** / Cruna guida catena >pag 225
- Fork protectors** / Parasteli forcella >pag 226
- Chain slider** / Slitta scorricatena forcellone >pag 226
- Chain pad** / Pattino scorricatena >pag 226
- Rear shock mud flap** / Paraspruzzi monoammortizzatore >pag 226
- Replica plastics kit** / Kit plastiche replica >pag 227

# GAS GAS FRONT FENDER / PARAFANGO ANTERIORE



R-PAGASRG9921 R-PAGASBN9921 R-PAGASNR9921

## AVAILABLE COLORS

|  |             |  |              |
|--|-------------|--|--------------|
|  | GG Red      |  | Black        |
|  | Neon Yellow |  | Blue         |
|  | White       |  | Quantum Grey |

**OEM** original color

| MODEL                       | CC                  | YEAR        | NOTES  | COLOR        | CODE          | PRICE   |
|-----------------------------|---------------------|-------------|--|--------------|---------------|---------|
| MC-E                        | 3 - 5               | 2023        | OEM  | GG Red       | R-PAKTMRG0050 | € 25,95 |
|                             |                     |             |  | Black        | R-PAKTMNR0050 |         |
|                             |                     |             |  | White        | R-PAKTMBN0050 |         |
| MC                          | 50                  | 2021 > 2023 | OEM  | GG Red       | R-PAKTMRG0050 | € 25,95 |
|                             |                     |             |  | Black        | R-PAKTMNR0050 |         |
|                             |                     |             |  | White        | R-PAKTMBN0050 |         |
| MC                          | 65                  | 2021 > 2023 | OEM  | GG Red       | R-PAKTMRG1665 | € 32,95 |
|                             |                     |             |  | Black        | R-PAKTMNR1665 |         |
|                             |                     |             |  | White        | R-PAKTMBN1665 |         |
| MC                          | 85                  | 2021 > 2123 | OEM  | GG Red       | R-PAKTMRG0185 | € 32,95 |
|                             |                     |             |  | Black        | R-PAKTMBN0185 |         |
|                             |                     |             |  | White        | R-PAKTMNR0185 |         |
| EC / MC / FSR               | 125-200-250-300-450 | 2001 > 2007 | OEM  | Neon Yellow  | R-PAKTMGF0185 | € 29,95 |
|                             |                     |             |  | GG Red       | R-PAYZORGAS7  |         |
|                             |                     |             |  | Blue         | R-PAYZBLGAS7  |         |
| EC / MC / FSR               | 125-200-250-300-450 | 2008 > 2010 | OEM  | GG Red       | R-PAGASRG0008 | € 29,95 |
|                             |                     |             |  | White        | R-PAGASBN0008 |         |
|                             |                     |             |  | Blue         | R-PAGASBL0008 |         |
| EC / MC                     | 125-200-250-300     | 2011        | OEM  | Black        | R-PAGASNR0008 | € 29,95 |
|                             |                     |             |  | White        | R-PAGASBN0011 |         |
|                             |                     |             |  | Black        | R-PAGASNR0011 |         |
| ECF                         | 250-300             | 2011 > 2013 | OEM  | GG Red       | R-PAGASRG0011 | € 29,95 |
|                             |                     |             |  | White        | R-PAGASBN0011 |         |
|                             |                     |             |  | Black        | R-PAGASNR0011 |         |
| MC/MC-F/EC/<br>EC-F/EX/EX-F | 125-250-300-350-450 | 2021 > 2023 | OEM - Vented front fender<br>Vented front fender<br>Vented front fender<br>Vented front fender | GG Red       | R-PAGASRG0011 | € 36,95 |
|                             |                     |             |  | GG Red       | R-PAGASRG9921 |         |
|                             |                     |             |  | Black        | R-PAGASNR9921 |         |
|                             |                     |             |  | White        | R-PAGASBN9921 |         |
|                             |                     |             |  | Quantum Grey | R-PAGASGR9921 |         |

# GAS GAS REAR FENDER / PARAFANGO POSTERIORE

**OEM** original color

| MODEL               | CC                  | YEAR        | NOTES                     | COLOR        | CODE          | PRICE   |
|---------------------|---------------------|-------------|---------------------------|--------------|---------------|---------|
| MC-E                | 3 - 5               | 2023        | OEM                       | GG Red       | R-PPKTMRG0050 | € 49,95 |
|                     |                     |             |                           | Black        | R-PPKTMNR0050 |         |
|                     |                     |             |                           | White        | R-PPKTMBN0050 |         |
| MC                  | 50                  | 2021 > 2023 | OEM                       | GG Red       | R-PPKTMRG0050 | € 49,95 |
|                     |                     |             |                           | Black        | R-PPKTMNR0050 |         |
|                     |                     |             |                           | White        | R-PPKTMBN0050 |         |
| MC                  | 65                  | 2021 > 2023 | OEM                       | GG Red       | R-PPKTMRG1665 | € 62,95 |
|                     |                     |             |                           | Black        | R-PPKTMNR1665 |         |
|                     |                     |             |                           | White        | R-PPKTMBN1665 |         |
| MC                  | 85                  | 2021 > 2023 | OEM                       | GG Red       | R-PPKTMRG0185 | € 32,95 |
|                     |                     |             |                           | Black        | R-PPKTMNR0185 |         |
|                     |                     |             |                           | White        | R-PPKTMBN0185 |         |
| EC / MC / FSR       | 125-200-250-300-450 | 2007 > 2008 | OEM                       | Neon Yellow  | R-PPKTMGF0185 | € 86,95 |
|                     |                     |             |                           | GG Red       | R-CDGASRG0007 |         |
|                     |                     |             |                           | White        | R-CDGASBN0007 |         |
| EC-MC               | 125-200-250-300-450 | 2010-2011   | OEM - 2011                | Blue         | R-CDGASBL0007 | € 90,95 |
|                     |                     |             |                           | Black        | R-CDGASNR0007 |         |
|                     |                     |             |                           | White        | R-CDGASBN0010 |         |
| ECF                 | 250-300             | 2011 > 2013 | OEM                       | GG Red       | R-CDGASRG0010 | € 90,95 |
|                     |                     |             |                           | Black        | R-CDGASNR0010 |         |
|                     |                     |             |                           | White        | R-CDGASBN0010 |         |
| EC/EC-F             | 250-300-350         | 2021 > 2023 | OEM 2021-2022<br>OEM 2023 | GG Red       | R-CDGASRG0010 | € 52,95 |
|                     |                     |             |                           | Black        | R-CDGASNR0010 |         |
|                     |                     |             |                           | White        | R-PPGASBN0022 |         |
| MC/MC-F/EX/<br>EX-F | 125-250-300-350-450 | 2021 > 2023 | OEM 2021 > 2023           | GG Red       | R-PPGASRG0022 | € 52,95 |
|                     |                     |             |                           | Black        | R-PPGASNR0022 |         |
|                     |                     |             |                           | Quantum Grey | R-PPGASGR0022 |         |
|                     |                     |             |                           | White        | R-PPGASBN0021 |         |
|                     |                     |             |                           | GG Red       | R-PPGASRG0021 |         |
|                     |                     |             |                           | Black        | R-PPGASNR0021 |         |
|                     |                     |             |                           | Quantum Grey | R-PPGASGR0021 |         |

## GAS GAS RADIATOR SHROUDS / CONVOGLIATORI ARIA RADIATORE



R-CVGASBL0010



R-CVGASBN0010



R-CVGASRG0021

**OEM original color**

| MODEL                       | CC                  | YEAR        | NOTES    | COLOR             | CODE            | PRICE   |
|-----------------------------|---------------------|-------------|----------|-------------------|-----------------|---------|
| MC-E                        | 3 - 5               | 2023        | OEM      | GG Red            | R-CVKTMRG0050   | € 57,95 |
|                             |                     |             |          | White             | R-CVKTMBN0050   |         |
|                             |                     |             |          | Black             | R-CVKTMRN0050   |         |
| MC                          | 50                  | 2021 > 2023 | OEM      | GG Red            | R-CVKTMRG0050   | € 57,95 |
|                             |                     |             |          | White             | R-CVKTMBN0050   |         |
|                             |                     |             |          | Black             | R-CVKTMRN0050   |         |
| MC                          | 65                  | 2021 > 2023 | OEM      | GG Red            | R-CVKTMRG1665   | € 57,95 |
|                             |                     |             |          | White-Black       | R-CVKTMBNNR1665 |         |
|                             |                     |             |          | Black             | R-CVKTMRN1665   |         |
| MC                          | 85                  | 2021 > 2023 | OEM      | GG Red            | R-CVKTMRG0185   | € 59,95 |
|                             |                     |             |          | White             | R-CVKTMBN0185   |         |
|                             |                     |             |          | Black             | R-CVKTMRN0185   |         |
|                             |                     |             |          | Neon Yellow-Black | R-CVKTMGF0185   |         |
| EC / MC / FSR               | 125-200-250-300-450 | 2007 > 2009 |          | GG Red            | R-CVGASRG0007   | € 79,95 |
|                             |                     |             |          | White             | R-CVGASBN0007   |         |
|                             |                     |             |          | Blue              | R-CVGASBL0007   |         |
|                             |                     |             |          | Black             | R-CVGASNR0007   |         |
| EC / MC / FSR               | 125-200-250-300-450 | 2010-2011   | OEM 2011 | GG Red            | R-CVGASRG0010   | € 81,95 |
|                             |                     |             |          | White             | R-CVGASBN0010   |         |
|                             |                     |             |          | Blue              | R-CVGASBL0010   |         |
|                             |                     |             |          | Black             | R-CVGASNR0010   |         |
| ECF                         | 250-300             | 2011 > 2013 | OEM      | GG Red            | R-CVGASRG0010   | € 81,95 |
|                             |                     |             |          | White             | R-CVGASBN0010   |         |
|                             |                     |             |          | Blue              | R-CVGASBL0010   |         |
|                             |                     |             |          | Black             | R-CVGASNR0010   |         |
| MC/MC-F/EC/<br>EC-F/EX/EX-F | 125-250-300-350-450 | 2021 > 2023 | OEM      | GG Red            | R-CVGASRG0021   | € 59,95 |
|                             |                     |             |          | White             | R-CVGASBN0021   |         |
|                             |                     |             |          | Black             | R-CVGASNR0021   |         |
|                             |                     |             |          | Quantum Grey      | R-CVGASGR0021   |         |



R-FIGASBNR21



R-FIGASGRNR21

## GAS GAS SIDE PANELS / TABELLE LATERALI PORTANUMERO

**OEM original color**

| MODEL              | CC                  | YEAR        | NOTES           | COLOR              | CODE          | PRICE   |
|--------------------|---------------------|-------------|-----------------|--------------------|---------------|---------|
| MC                 | 85                  | 2021 > 2023 | OEM             | GG Red             | R-FIKTMRG0185 | € 43,95 |
|                    |                     |             |                 | White-Black        | R-FIKTMBN0185 |         |
|                    |                     |             |                 | Black              | R-FIKTMRN0185 |         |
|                    |                     |             |                 | Neon Yellow        | R-FIKTMGF0185 |         |
| MC/MC-F            | 125-250-300-350-450 | 2021 > 2023 | OEM 2021 > 2023 | GG Red-Black       | R-FIGASGRNR21 | € 59,95 |
|                    |                     |             |                 | White-Black        | R-FIGASBNR21  |         |
|                    |                     |             |                 | Black              | R-FIGASNR0021 |         |
|                    |                     |             |                 | Quantum Grey-Black | R-FIGASGRNR21 |         |
| EC/EC-F<br>EX/EX-F | 125-250-300-350-450 | 2021 > 2023 | OEM 2023        | GG Red-Black       | R-FIGASGRNR21 | € 59,95 |
|                    |                     |             |                 | White-Black        | R-FIGASBNR21  |         |
|                    |                     |             | OEM 2021-2022   | Black              | R-FIGASNR0021 |         |
|                    |                     |             |                 | Quantum Grey-Black | R-FIGASGRNR21 |         |

## GAS GAS AIR BOX COVER / COPERCHIO LATERALE CASSA FILTRO



R-FIGASRGSX21



R-FIGASGRSX21



R-FIGASNRSX99



R-FIGASRGSX99

### AVAILABLE COLORS



**OEM** original color

| MODEL              | CC                  | YEAR        | NOTES                       | COLOR        | CODE           | PRICE   |
|--------------------|---------------------|-------------|-----------------------------|--------------|----------------|---------|
| MC                 | 85                  | 2021 > 2023 | OEM                         | GG Red       | R-FIKTMRGSX185 | € 23,95 |
|                    |                     |             |                             | White-Black  | R-FIKTMBNSX185 |         |
|                    |                     |             |                             | Black        | R-FIKTMNRSX185 |         |
|                    |                     |             |                             | Neon Yellow  | R-FIKTMGFSX185 |         |
| MC/MC-F            | 125-250-300-350-450 | 2021 > 2023 | OEM 2021 > 2023             | GG Red       | R-FIGASRGSX21  | € 25,95 |
|                    |                     |             |                             | White        | R-FIGASBNSX21  |         |
|                    |                     |             |                             | Black        | R-FIGASNRSX21  |         |
|                    |                     |             |                             | Quantum Grey | R-FIGASGRSX21  |         |
| EC/EC-F<br>EX/EX-F | 125-250-300-350-450 | 2021 > 2023 | OEM 2023<br>OEM 2021-2022   | GG Red       | R-FIGASRGSX21  | € 25,95 |
|                    |                     |             |                             | White        | R-FIGASBNSX21  |         |
|                    |                     |             |                             | Black        | R-FIGASNRSX21  |         |
|                    |                     |             |                             | Quantum Grey | R-FIGASGRSX21  |         |
| MC/MC-F            | 125-250-300-350-450 | 2021 > 2023 | OEM 2021 > 2023             | GG Red       | R-FIKTMRGSX99  | € 25,95 |
|                    |                     |             |                             | White        | R-FIKTMBNSX99  |         |
|                    |                     |             |                             | Black        | R-FIKTMNRSX99  |         |
|                    |                     |             |                             | Quantum Grey | R-FIKTMGRSX99  |         |
| EC/EC-F<br>EX/EX-F | 125-250-300-350-450 | 2021 > 2023 | OEM 2023<br>OEM 2021 > 2023 | GG Red       | R-FIKTMRGSX99  | € 25,95 |
|                    |                     |             |                             | White        | R-FIKTMBNSX99  |         |
|                    |                     |             |                             | Black        | R-FIKTMNRSX99  |         |
|                    |                     |             |                             | Quantum Grey | R-FIKTMGRSX99  |         |



Pack Of 5 pcs  
R-BOCKTMNR516

### AVAILABLE COLORS



**OEM** original color

| MODEL                       | CC                  | YEAR        | NOTES                      | COLOR   | CODE          | PRICE  |
|-----------------------------|---------------------|-------------|----------------------------|---------|---------------|--------|
| MC                          | 85                  | 2021 > 2023 | for side panels and airbox | Black   | R-BOCKTMNR516 | € 9,95 |
|                             |                     |             | for side panels and airbox | Neutral | R-BOCKTMNT516 |        |
| MC/MC-F/EC/<br>EC-F/EX/EX-F | 125-250-300-350-450 | 2021 > 2023 | for side panels and airbox | Black   | R-BOCKTMNR516 | € 9,95 |
|                             |                     |             | for side panels and airbox | Neutral | R-BOCKTMNT516 |        |

## GAS GAS OVERSIZE REINFORCED RADIATOR LOUVERS GRIGLIE RADIATORE RINFORZATE MAGGIORATE

**OEM** original color

| MODEL                    | CC                  | YEAR        | NOTES | COLOR  | CODE          | PRICE   |
|--------------------------|---------------------|-------------|-------|--------|---------------|---------|
| MC-MCF-EC-<br>ECF-EX-EXF | 125-250-300-350-450 | 2021 > 2023 | OEM   | GG Red | R-GRKTMRG0019 | € 43,95 |
|                          |                     |             |       | White  | R-GRKTMBN0019 |         |
|                          |                     |             |       | Black  | R-GRKTMNR0019 |         |









## GAS GAS REPLACEMENT INNER RADIATOR LOUVERS (2 PCS) RICAMBIO INTERNO GRIGLIE RADIATORE (2 PZ)

**OEM** original color

| MODEL                    | CC                  | YEAR        | NOTES | COLOR  | CODE          | PRICE   |
|--------------------------|---------------------|-------------|-------|--------|---------------|---------|
| MC-MCF-EC-<br>ECF-EX-EXF | 125-250-300-350-450 | 2021 > 2023 | OEM   | GG Red | R-REPGRKTMRG9 | € 23,95 |
|                          |                     |             |       | White  | R-REPGRKTMBN9 |         |
|                          |                     |             |       | Black  | R-REPGRKTMNR9 |         |

## GAS GAS FRONT HEADLIGHT / MASCHERINA PORTAFARO

### AVAILABLE COLORS

|   |  |
|---|--|
|  GG Red      |  Black        |
|  Neon Yellow |  White-Black  |
|  White       |  Quantum Grey |



















**OEM** original color

| MODEL   | CC          | YEAR        | NOTES | COLOR        | CODE  | PRICE   |
|---------|-------------|-------------|-------|--------------|---|---------|
| EC/EC-F | 250-300-350 | 2021 > 2023 | OEM   | GG Red       |  R-MASKGASRG21 | € 29,95 |
|         |             |             |       | White        |  R-MASKGASBN21 |         |
|         |             |             |       | Black        |  R-MASKGASNR21 |         |
|         |             |             |       | Quantum Grey |  R-MASKGASGR21 |         |

## GAS GAS FRONT NUMBER PLATE / TABELLA PORTANUMERO ANTERIORE

**OEM** original color

| MODEL               | CC                  | YEAR        | NOTES | COLOR        | CODE  | PRICE   |
|---------------------|---------------------|-------------|-------|--------------|---|---------|
| MC-E                | 3 - 5               | 2023        | OEM   | GG Red       |  R-TBKTMRG0050   | € 25,95 |
|                     |                     |             |       | White        |  R-TBKTMBN0050   |         |
|                     |                     |             |       | Black        |  R-TBKTMRN0050   |         |
| MC                  | 50                  | 2021 > 2023 | OEM   | GG Red       |  R-TBKTMRG0050   | € 25,95 |
|                     |                     |             |       | White        |  R-TBKTMBN0050   |         |
|                     |                     |             |       | Black        |  R-TBKTMRN0050   |         |
| MC                  | 65                  | 2021 > 2023 | OEM   | GG Red       |  R-TBKTMRG1665   | € 25,95 |
|                     |                     |             |       | White        |  R-TBKTMBN1665  |         |
|                     |                     |             |       | Black        |  R-TBKTMRN1665 |         |
| MC                  | 85                  | 2021 > 2023 | OEM   | GG Red       |  R-TBKTMRG0185 | € 27,95 |
|                     |                     |             |       | White        |  R-TBKTMBN0185 |         |
|                     |                     |             |       | Black        |  R-TBKTMRN0185 |         |
|                     |                     |             |       | Neon Yellow  |  R-TBKTMGF0185 |         |
| MC/MC-F/EX/<br>EX-F | 125-250-300-350-450 | 2021 > 2023 | OEM   | GG Red       |  R-TBGASRG0021 | € 29,95 |
|                     |                     |             |       | White        |  R-TBGASBN0021 |         |
|                     |                     |             |       | Black        |  R-TBGASNR0021 |         |
|                     |                     |             |       | Quantum Grey |  R-TBGASGR0021 |         |



| MODEL     | CC          | YEAR        | NOTES                                  | COLOR | CODE  | PRICE   |
|-----------|-------------|-------------|--|-------|---|---------|
| EC / EC-F | 250-300-350 | 2021 > 2023 | Cp. Replacement Mounting Elastic Bands | Black |  R-ELASTNR0020 | € 10,95 |

## GAS GAS CHAIN GUIDE / CRUNA GUIDA CATENA

**OEM** original color

| MODEL         | CC                  | YEAR        | NOTES | COLOR         | CODE   | PRICE   |
|---------------|---------------------|-------------|-------|---------------|--|---------|
| MC            | 65                  | 2021 > 2023 | OEM   | Black         |  R-CRUKTMNR165  | € 25,95 |
| MC            | 85                  | 2021 > 2023 | OEM   | Black-Neutral |  R-CRUKTMNRNT14 | € 38,95 |
| EC/EC-F       | 250-300-350         | 2021 > 2023 | OEM   | Black-Neutral |  R-CRUKTMNRNT14 | € 38,95 |
| MC/MCF/EX/EXF | 125-250-300-350-450 | 2021 > 2023 | OEM   | Black         |  R-CRUKTMNR016  | € 38,95 |



MONOBLOCK R2.0 WORX CHAIN GUIDE - PAG. 254

## GAS GAS FORK PROTECTORS / PARASTELI FORCELLA



R-PSKTMBN0015



R-PSKTMNR0015



R-PSKTMRG0021



R-PSKTMGR0020

### AVAILABLE COLORS



**OEM** original color

| MODEL                | CC                  | YEAR        | NOTES | COLOR                                    | CODE   | PRICE   |
|----------------------|---------------------|-------------|-------|--|--|---------|
| MC-E                 | 3 - 5               | 2023        | OEM   | GG Red<br>Black<br>White                 | R-PSKTMRG1965<br>R-PSKTMNR1965<br>R-PSKTMBN1965                  | € 29,95 |
| MC                   | 65                  | 2021 > 2023 | OEM   | GG Red<br>Black<br>White                 | R-PSKTMRG1965<br>R-PSKTMNR1965<br>R-PSKTMBN1965                  | € 29,95 |
| MC                   | 85                  | 2021 > 2023 | OEM   | GG Red<br>Black<br>White<br>Neon Yellow  | R-PSKTMRG0185<br>R-PSKTMNR0185<br>R-PSKTMBN0185<br>R-PSKTMGF0185 | € 31,95 |
| EC/MC/FSR            | 125-200-250-300-450 | 2001 > 2008 |       | White<br>GG Red                          | R-PSCR0BN0003<br>R-PSCR0RG0003                                   | € 34,95 |
| EC/MC/FSR            | 125-200-250-300-450 | 2009 > 2013 | OEM   | GG Red<br>White<br>Black                 | R-PSKTMRG0008<br>R-PSKTMBN0008<br>R-PSKTMNR0008                  | € 34,95 |
| MC-MCF-EC-ECF-EX-EXF | 125-250-300-350-450 | 2021 > 2023 | OEM   | GG Red<br>White<br>Black<br>Quantum Grey | R-PSKTMRG0021<br>R-PSKTMBN0020<br>R-PSKTMNR0015<br>R-PSKTMGR0020 | € 34,95 |

## GAS GAS CHAIN SLIDER / SLITTA SCORRICATENA FORCELLONE

**OEM** original color

| MODEL         | CC                  | YEAR        | NOTES | COLOR | CODE          | PRICE   |
|---------------|---------------------|-------------|-------|-------|---------------|---------|
| MC            | 65                  | 2021 > 2023 | OEM   | Black | R-SLIKTMNR165 | € 25,95 |
| MC            | 85                  | 2021 > 2023 | OEM   | Black | R-SLIKTMNR185 | € 25,95 |
| EC/EC-F       | 250-300-350         | 2021 > 2023 | OEM   | Black | R-SLIKTMNR011 | € 25,95 |
| MC/MCF/EX/EXF | 125-250-300-350-450 | 2021 > 2023 | OEM   | Black | R-SLIKTMNR011 | € 25,95 |

## GAS GAS CHAIN PAD / PATTINO SCORRICATENA

**OEM** original color

| MODEL         | CC                  | YEAR        | NOTES | COLOR | CODE          | PRICE  |
|---------------|---------------------|-------------|-------|-------|---------------|--------|
| MC            | 65                  | 2021 > 2023 | OEM   | Black | R-PATTKTMNR01 | € 9,95 |
| MC            | 85                  | 2021 > 2023 | OEM   | Black | R-PATTKTMNR11 | € 9,95 |
| EC/EC-F       | 125-250-300-350-450 | 2021 > 2023 | OEM   | Black | R-PATTKTMNR16 | € 9,95 |
| MC/MCF/EX/EXF | 125-250-300-350-450 | 2021 > 2023 | OEM   | Black | R-PATTKTMNR16 | € 9,95 |

## GAS GAS REAR SHOCK MUD FLAP / PARASPRUZZI MONOAMMORTIZZATORE

**OEM** original color

| MODEL         | CC                  | YEAR        | NOTES | COLOR | CODE          | PRICE   |
|---------------|---------------------|-------------|-------|-------|---------------|---------|
| MC            | 65                  | 2021 > 2023 | OEM   | Black | R-PSPKTMNR165 | € 18,95 |
| MC            | 85                  | 2021 > 2023 | OEM   | Black | R-PSPKTMNR185 | € 14,95 |
| MC/MCF/EX/EXF | 125-250-300-350-450 | 2021 > 2023 | OEM   | Black | R-PSPKTMNR016 | € 14,95 |
| EC/EC-F       | 125-250-300-350-450 | 2021 > 2023 | OEM   | Black | R-PSPKTMNR016 | € 14,95 |



R-KITGAS-RG0-521

**OEM** original color

| MOD             | CC                  | YEAR             | NOTES                      | COLOR        |  | CODE             | PRICE    |
|-----------------|---------------------|------------------|----------------------------|--------------|--|------------------|----------|
| MC-E            | 3-5                 | 2023             | OEM                        | GG Red       |  | R-KITKTM-RG0-050 | € 124,95 |
|                 |                     |                  |                            | Black        |  | R-KITKTM-NR0-050 |          |
|                 |                     |                  |                            | White        |  | R-KITKTM-BN0-050 |          |
| MC              | 50                  | 2021 > 2023      | OEM                        | GG Red       |  | R-KITKTM-RG0-050 | € 124,95 |
|                 |                     |                  |                            | Black        |  | R-KITKTM-NR0-050 |          |
|                 |                     |                  |                            | White        |  | R-KITKTM-BN0-050 |          |
| MC              | 65                  | 2021 > 2023      | OEM                        | GG Red       |  | R-KITKTM-RG0-500 | € 134,95 |
|                 |                     |                  |                            | Black        |  | R-KITKTM-NR0-500 |          |
|                 |                     |                  |                            | White        |  | R-KITKTM-BN0-500 |          |
| MC              | 85                  | 2021 > 2023      | OEM                        | GG Red       |  | R-KITKTM-RG0-185 | € 147,95 |
|                 |                     |                  |                            | Black        |  | R-KITKTM-NR0-185 |          |
|                 |                     |                  |                            | White        |  | R-KITKTM-BN0-185 |          |
|                 |                     |                  |                            | Neon Yellow  |  | R-KITKTM-GF0-185 |          |
| EC/MC/FSR       | 125-200-250-300-450 | 2007 > 2009      | OEM                        | OEM          |  | R-KITGAS-OEM-402 | € 124,95 |
| EC/MC/FSR       | 125-250-300-450     | 2010             | OEM                        | Blue         |  | R-KITGAS-BL0-402 | € 124,95 |
|                 |                     |                  |                            | White        |  | R-KITGAS-OEM-403 |          |
| EC/MC           | 125-200-250-300-450 | 2011             | OEM                        | Blue         |  | R-KITGAS-BL0-403 | € 124,95 |
|                 |                     |                  |                            | Black        |  | R-KITGAS-NR0-403 |          |
|                 |                     |                  |                            | White        |  | R-KITGAS-OEM-404 |          |
|                 |                     |                  |                            | GG Red       |  | R-KITGAS-RG0-404 |          |
| FSR             | 250                 | 2011 > 2013      | OEM                        | White        |  | R-KITGAS-OEM-404 | € 124,95 |
|                 |                     |                  |                            | Black        |  | R-KITGAS-NR0-404 |          |
|                 |                     |                  |                            | GG Red       |  | R-KITGAS-RG0-404 |          |
|                 |                     |                  |                            | GG Red       |  | R-KITGAS-RG0-404 |          |
| MC/MC-F/EX/EX-F | 125-250-300-350-450 | 2021 > 2023      | OEM                        | GG Red       |  | R-KITGAS-RG0-599 | € 159,95 |
|                 |                     |                  |                            | Black        |  | R-KITGAS-NR0-599 |          |
|                 |                     |                  |                            | White        |  | R-KITGAS-BN0-599 |          |
|                 |                     |                  |                            | Quantum Grey |  | R-KITGAS-GR0-599 |          |
|                 |                     |                  |                            | GG Red       |  | R-KITGAS-RG0-609 |          |
| EC/EC-F         | 250-300-350         | 2021 > 2023      | OEM - With fork protectors | GG Red       |  | R-KITGAS-OEM-421 | € 147,95 |
|                 |                     |                  |                            | GG Red-White |  | R-KITGAS-RG0-421 |          |
|                 |                     |                  |                            | Black        |  | R-KITGAS-NR0-421 |          |
|                 |                     |                  |                            | White        |  | R-KITGAS-BN0-421 |          |
|                 |                     |                  |                            | GG Red-White |  | R-KITGAS-OEM-521 |          |
|                 |                     |                  |                            | GG Red       |  | R-KITGAS-RG0-521 |          |
|                 |                     |                  |                            | Black        |  | R-KITGAS-NR0-521 |          |
|                 |                     |                  |                            | White        |  | R-KITGAS-BN0-521 |          |
|                 |                     |                  |                            | Quantum Grey |  | R-KITGAS-GR0-521 |          |
|                 |                     |                  |                            | GG Red-White |  | R-KITGAS-OEM-621 |          |
| GG Red-White    |                     | R-KITGAS-RG0-621 |                            |              |  |                  |          |
|                 |                     | OEM 2021-2022    | With fork protectors       | GG Red-White |  | R-KITGAS-OEM-621 | € 172,95 |
|                 |                     | OEM 2023         | With fork protectors       | GG Red-White |  | R-KITGAS-RG0-621 | € 172,95 |





## **BETA**

**Vented front fender** / Parafango anteriore ventilato >pag 230

**Rear fender** / Parafango posteriore >pag 230

**Radiator shrouds** / Convogliatori aria radiatore >pag 231

**Side panels** / Tabelle laterali portanumero >pag 231

**Front number plate** / Tabella portanumero anteriore >pag 232

**Front headlight** / Mascherina portafaro >pag 232

**Fork protectors** / Parasteli forcella >pag 233

**Chain slider** / Slitta scorricatena forcellone >pag 234

**Rear shock mud flap** / Paraspruzzi monoammortizzatore >pag 234

**Increased bike stand foot** / Piedino cavalletto maggiorato >pag 234

**Replica plastics kit** / Kit plastiche replica >pag 235

## BETA VENTED FRONT FENDER / PARAFANGO ANTERIORE VENTILATO

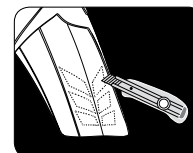

### AVAILABLE COLORS

- Beta Red
- Black
- White
- Neon Yellow
- Quantum Grey

**OEM** original color

| MOD     | CC        | YEAR        | NOTES | COLOR        | CODE          | PRICE   |
|---------|-----------|-------------|-------|--------------|---------------|---------|
| RR / RX | 125 > 480 | 2020 > 2023 | OEM   | Beta Red     | R-PABETRS9920 | € 36,95 |
|         |           |             |       | White        | R-PABETBN9920 |         |
|         |           |             |       | Black        | R-PABETNR9920 |         |
|         |           |             |       | Quantum Grey | R-PABETGR9920 |         |
|         |           |             |       | Neon Yellow  | R-PABETGF9920 |         |

## BETA REAR FENDER / PARAFANGO POSTERIORE



**OEM** original color

| MOD | CC        | YEAR        | NOTES | COLOR        | CODE          | PRICE   |
|-----|-----------|-------------|-------|--------------|---------------|---------|
| RR  | 125 > 480 | 2020 > 2023 | OEM   | Beta Red     | R-CDBETRS0020 | € 69,95 |
|     |           |             |       | White        | R-CDBETBN0020 |         |
|     |           |             |       | Black        | R-CDBETNR0020 |         |
|     |           |             |       | Quantum Grey | R-CDBETGR0020 |         |
|     |           |             |       | Neon Yellow  | R-CDBETGF0020 |         |
| RX  | 125 > 480 | 2020 > 2023 | OEM   | Beta Red     | R-CDBETRS0022 | € 69,95 |
|     |           |             |       | White        | R-CDBETBN0022 |         |
|     |           |             |       | Black        | R-CDBETNR0022 |         |
|     |           |             |       | Quantum Grey | R-CDBETGR0022 |         |
|     |           |             |       | Neon Yellow  | R-CDBETGF0022 |         |

## BETA RADIATOR SHROUDS / CONVOGLIATORI ARIA RADIATORE



Supporto switch centralina non integrato con la cover serbatoio, incluso nella confezione dei convogliatori.

Specific map switch support that doesn't require the stock gas tank cover.

**OEM** original color

| MOD     | CC        | YEAR        | NOTES  | COLOR              | CODE           | PRICE   |
|---------|-----------|-------------|--|--------------------|----------------|---------|
| RR / RX | 125 > 480 | 2020 > 2022 | OEM  | Beta Red           | R-CVBETRS0020  | € 69,95 |
|         |           |             |  | White              | R-CVBETBN0020  |         |
|         |           |             |  | Black              | R-CVBETNR0020  |         |
|         |           |             |  | Quantum Grey       | R-CVBETRGR020  |         |
|         |           |             |  | Neon Yellow        | R-CVBETRGF020  |         |
| RR / RX | 125 > 480 | 2023        | OEM - adaptale from 2020<br>adaptale from 2020<br>adaptale from 2020<br>adaptale from 2020<br>adaptale from 2020 | Beta Red-Black     | R-CVBETRSNR23  | € 69,95 |
|         |           |             |  | Blue-Beta Red      | R-CVBETBLRS23  |         |
|         |           |             |  | White-Black        | R-CVBETBNNR23  |         |
|         |           |             |  | Black              | R-CVBETNR0023  |         |
|         |           |             |  | Quantum Grey-Black | R-CVBETRGRNR23 |         |
|         |           |             |  | Neon Yellow-Black  | R-CVBETGFNR23  |         |

**NEW**

## BETA AIR BOX COVER / COPERCHIO LATERALE CASSA FILTRO

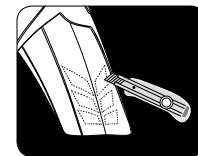

The left side panel is provided with a pre-cut for opening the additional intake hole.  
Use a cutter and cut along the inside edges of the air intake to open the hole.

**OEM** original color

| MOD     | CC        | YEAR        | NOTES | COLOR        | CODE          | PRICE   |
|---------|-----------|-------------|-------|--------------|---------------|---------|
| RR / RX | 125 > 480 | 2020 > 2023 | OEM   | Beta Red     | R-FIBETRSSX20 | € 23,95 |
|         |           |             |       | White        | R-FIBETBNSX20 |         |
|         |           |             |       | Black        | R-FIBETNRSX20 |         |
|         |           |             |       | Quantum Grey | R-FIBETRGSX20 |         |
|         |           |             |       | Neon Yellow  | R-FIBETGFSX20 |         |

### AVAILABLE COLOURS

-  Black
-  Neutral



Pack Of 5 pcs  
R-BOCKTMNR516

| MOD     | CC        | YEAR        | NOTES  | COLOR   | CODE          | PRICE  |
|---------|-----------|-------------|--|---------|---------------|--------|
| RR / RX | 125 > 480 | 2020 > 2023 | for side panels and airbox<br>for side panels and airbox | Black   | R-BOCKTMNR516 | € 8,95 |
|         |           |             |  | Neutral | R-BOCKTMNT516 |        |

## BETA FRONT NUMBER PLATE / TABELLA PORTANUMERO ANTERIORE



Tabella portanumero anteriore con protezioni piastre, facili da installare o rimuovere.  
Protezioni piastre incluse di colore nero, disponibili come ricambio anche in altri colori.

*Motocross front number plate supplied with extra protections to cover the lower triple clamp, easy to fit and remove.  
The lower triple clamp protections included are black, also available as spare parts in other colors.*

viti di montaggio  
mounting screws



**OEM** original color

| MOD | CC        | YEAR        | NOTES | COLOR        | CODE          | PRICE   |
|-----|-----------|-------------|-------|--------------|---------------|---------|
| RX  | 125 > 480 | 2020 > 2023 | OEM   | Beta Red     | R-TBBETRS0021 | € 29,95 |
|     |           |             |       | White        | R-TBBETBN0021 |         |
|     |           |             |       | Black        | R-TBBETNR0021 |         |
|     |           |             |       | Quantum Grey | R-TBBETGR0021 |         |
|     |           |             |       | Neon Yellow  | R-TBBETGF0021 |         |

## BETA FRONT HEADLIGHT / MASCHERINA PORTAFARO

Mascherina portafaro anteriore con protezioni piastre, facili da installare o rimuovere.  
Protezioni piastre incluse di colore nero, disponibili come ricambio anche in altri colori.

*Enduro front headlight supplied with extra protections to cover the lower triple clamp, easy to fit and remove.  
The lower triple clamp protections included are black, also available as spare parts in other colors.*



**OEM** original color

| MOD | CC        | YEAR        | NOTES | COLOR        | CODE          | PRICE   |
|-----|-----------|-------------|-------|--------------|---------------|---------|
| RR  | 125 > 480 | 2020 > 2023 | OEM   | Beta Red     | R-MASKBETRS20 | € 29,95 |
|     |           |             |       | White        | R-MASKBETBN20 |         |
|     |           |             |       | Black        | R-MASKBETNR20 |         |
|     |           |             |       | Quantum Grey | R-MASKBETGR20 |         |
|     |           |             |       | Neon Yellow  | R-MASKBETGF20 |         |

## BETA TRIPLE CLAMPS PROTECTORS REPLACEMENT / RICAMBI PROTEZIONE FORCELLA



| MOD | CC        | YEAR        | NOTES  | COLOR    |  | CODE           | PRICE   |
|-----|-----------|-------------|--|----------|--|----------------|---------|
| RX  | 125 > 480 | 2020 > 2023 | For front motocross number plate<br>For front motocross number plate<br>For front motocross number plate | Beta Red |  | R-PRTPIARS0021 | € 14,95 |
|     |           |             |  | White    |  | R-PRTPIABN0021 |         |
|     |           |             |  | Black    |  | R-PRTPIANR0021 |         |
| RR  | 125 > 480 | 2020 > 2023 | For enduro headlight<br>For enduro headlight<br>For enduro headlight                                     | Beta Red |  | R-PRTPIARS0020 | € 14,95 |
|     |           |             |  | White    |  | R-PRTPIABN0020 |         |
|     |           |             |  | Black    |  | R-PRTPIANR0020 |         |



## BETA FORK PROTECTORS / PARASTELI FORCELLA

OEM original color

| MOD     | CC        | YEAR        | NOTES | COLOR    |  | CODE          | PRICE   |
|---------|-----------|-------------|-------|----------|--|---------------|---------|
| RR / RX | 125 > 480 | 2020 > 2023 | OEM   | Beta Red |  | R-PSBETRS0020 | € 34,95 |
|         |           |             |       | White    |  | R-PSBETBN0020 |         |
|         |           |             |       | Black    |  | R-PSBETNR0020 |         |

## BETA FACTORY FORK PROTECTORS / PARASTELI FORCELLA



### FACTORY EDITION

Parasteli Factory avvolgenti, con una più ampia superficie di protezione rispetto agli originali.

*Enveloping factory fork protectors with an enhanced cover surface for a better protection*

OEM original color

| MOD     | CC        | YEAR        | NOTES | COLOR        |  | CODE          | PRICE   |
|---------|-----------|-------------|-------|--------------|--|---------------|---------|
| RR / RX | 125 > 480 | 2020 > 2023 | OEM   | Beta Red     |  | R-PSBETRS0022 | € 34,95 |
|         |           |             |       | White        |  | R-PSBETBN0022 |         |
|         |           |             |       | Black        |  | R-PSBETNR0022 |         |
|         |           |             |       | Neon Yellow  |  | R-PSBETGF0022 |         |
|         |           |             |       | Quantum Grey |  | R-PSBETGR0022 |         |

**FACTORY EDITION**

## BETA CHAIN SLIDER / SLITTA SCORRICATENA FORCELLONE

OEM original color

| MOD     | CC        | YEAR        | NOTES | COLOR | CODE          | PRICE   |
|---------|-----------|-------------|-------|-------|---------------|---------|
| RR / RX | 125 > 480 | 2013 > 2023 | OEM   | Black | R-SLIBETNR020 | € 25,95 |



## BETA REAR SHOCK MUD FLAP / PARASPRUZZI MONOAMMORTIZZATORE

OEM original color

| MOD     | CC        | YEAR        | NOTES | COLOR | CODE          | PRICE   |
|---------|-----------|-------------|-------|-------|---------------|---------|
| RR / RX | 125 > 480 | 2020 > 2023 | OEM   | Black | R-PSPBETNR020 | € 18,95 |

## BETA PIEDINO CAVALLETTO MAGGIORATO INCREASED AND RAISED BIKE STAND FOOT



OEM original color

| MOD | CC        | YEAR        | NOTES | COLOR | CODE          | PRICE  |
|-----|-----------|-------------|-------|-------|---------------|--------|
| RR  | 125 > 480 | 2020 > 2023 |       | Black | R-PDCAVBETNR1 | € 4,95 |





OEM original color - ☀ fluorescent color

| MOD           | CC        | YEAR             | NOTES    | COLOR         |  | CODE             | PRICE    |
|---------------|-----------|------------------|----------|---------------|--|------------------|----------|
| RR            | 125 > 480 | 2020>2022        | OEM 2022 | Beta Red      |  | R-KITBET-RSO-520 | € 147,95 |
|               |           |                  |          | White         |  | R-KITBET-BNO-520 |          |
|               |           |                  |          | Black         |  | R-KITBET-NRO-520 |          |
|               |           |                  |          | Quantum Grey  |  | R-KITBET-GRO-520 |          |
| RR            | 125 > 480 | 2020>2022        | OEM 2022 | Beta Red      |  | R-KITBET-RSO-620 | € 172,95 |
|               |           |                  |          | White         |  | R-KITBET-BNO-620 |          |
|               |           |                  |          | Black         |  | R-KITBET-NRO-620 |          |
|               |           |                  |          | Quantum Grey  |  | R-KITBET-GRO-620 |          |
|               |           |                  |          | ☀ Neon Yellow |  | R-KITBET-GFO-620 |          |
|               |           |                  |          | Beta Red/Blue |  | R-KITBET-RSB-620 |          |
| RR            | 125 > 480 | 2023             | OEM 2023 | Beta Red      |  | R-KITBET-RSO-523 | € 147,95 |
|               |           |                  |          | White         |  | R-KITBET-BNO-523 |          |
|               |           |                  |          | Black         |  | R-KITBET-NRO-523 |          |
|               |           |                  |          | Quantum Grey  |  | R-KITBET-GRO-523 |          |
|               |           |                  |          | ☀ Neon Yellow |  | R-KITBET-GFO-523 |          |
|               |           |                  |          | Beta Red/Blue |  | R-KITBET-RSB-523 |          |
| RR            | 125 > 480 | 2023             | OEM 2023 | Beta Red      |  | R-KITBET-RSO-623 | € 172,95 |
|               |           |                  |          | White         |  | R-KITBET-BNO-623 |          |
|               |           |                  |          | Black         |  | R-KITBET-NRO-623 |          |
|               |           |                  |          | Quantum Grey  |  | R-KITBET-GRO-623 |          |
|               |           |                  |          | ☀ Neon Yellow |  | R-KITBET-GFO-623 |          |
|               |           |                  |          | Beta Red/Blue |  | R-KITBET-RSB-623 |          |
| RX            | 125 > 480 | 2020>2022        | OEM 2022 | Beta Red      |  | R-KITBET-RSO-622 | € 172,95 |
|               |           |                  |          | White         |  | R-KITBET-BNO-622 |          |
|               |           |                  |          | Black         |  | R-KITBET-NRO-622 |          |
|               |           |                  |          | Quantum Grey  |  | R-KITBET-GRO-622 |          |
| RX            | 125 > 480 | 2023             | OEM      | ☀ Neon Yellow |  | R-KITBET-GFO-622 | € 172,95 |
|               |           |                  |          | Beta Red/Blue |  | R-KITBET-RSB-624 |          |
|               |           |                  |          | Beta Red      |  | R-KITBET-RSO-624 |          |
|               |           |                  |          | White         |  | R-KITBET-BNO-624 |          |
|               |           |                  |          | Black         |  | R-KITBET-NRO-624 |          |
|               |           |                  |          | Quantum Grey  |  | R-KITBET-GRO-624 |          |
| ☀ Neon Yellow |           | R-KITBET-GFO-624 |          |               |  |                  |          |

NEW

NEW

NEW

## UNIVERSAL VENTED FRONT FENDER / PARAFANGO ANTERIORE UNIVERSALE VENTILATO

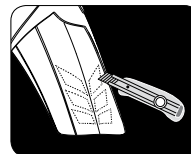

R-PAUNIBN0000



R-PAYZFB911  
pre-cut\*

☀️ fluorescent color

| BRAND     |  | COLOR              |  | CODE          | PRICE   |
|-----------|--|--------------------|--|---------------|---------|
| UNIVERSAL | RM 90 style - with mount holes                                       | White              |  | R-PAUNIBN0000 | € 29,95 |
| UNIVERSAL | RM 90 style - with mount holes                                       | Blue               |  | R-PAUNIBL0000 |         |
| UNIVERSAL | RM 90 style - with mount holes                                       | Black              |  | R-PAUNIR0000  |         |
| UNIVERSAL | RM 90 style - with mount holes                                       | Red                |  | R-PAUNIRS0000 |         |
| UNIVERSAL | YZF 10 > style - vented - no mount holes*                            | White              |  | R-PAYZFB911   | € 29,95 |
| UNIVERSAL | YZF 10 > style - vented - no mount holes*                            | YZ Blue            |  | R-PAYZFB911   |         |
| UNIVERSAL | YZF 10 > style - vented - no mount holes*                            | Black              |  | R-PAYZFN911   |         |
| UNIVERSAL | YZF 10 > style - vented - no mount holes*                            | YZ Yellow          |  | R-PAYZFG911   |         |
| UNIVERSAL | YZF 10 > style - vented - no mount holes*                            | ☀️ Neon Yellow     |  | R-PAYZFG911   | € 29,95 |
| UNIVERSAL | YZF 10 > style - vented - no mount holes*                            | ☀️ Ducati Neon Red |  | R-PAYZFR911   |         |
| UNIVERSAL | YZF 10 > style - vented - no mount holes*                            | Quantum Grey       |  | R-PAYZFG911   |         |
| UNIVERSAL | YZF 10 > style - vented - no mount holes*                            | YZ Blue            |  | R-PAYZFB911   |         |
| UNIVERSAL | To Drill As Drawing-Pre-Hole Vented Back For Airflow-Limited Edition | White              |  | R-PAYZFB911   | € 29,95 |
| UNIVERSAL | To Drill As Drawing-Pre-Hole Vented Back For Airflow-Limited Edition | Quantum Grey       |  | R-PAYZFG911   |         |
| UNIVERSAL | To Drill As Drawing-Pre-Hole Vented Back For Airflow-Limited Edition | Black              |  | R-PAYZFN911   |         |
| UNIVERSAL | To Drill As Drawing-Pre-Hole Vented Back For Airflow-Limited Edition | Black              |  | R-PAYZFN911   |         |

## UNIVERSAL VENTED SUPERMOTO FRONT FENDER PARAFANGO ANTERIORE SUPERMOTARD VENTILATO



R-PASMRRS0006



R-PASMRAR0006



R-PASMRGF0006

☀️ NEON



R-PASMRVF0006

☀️ fluorescent color

| BRAND     |  | COLOR          |  | CODE          | PRICE   |
|-----------|--|----------------|--|---------------|---------|
| UNIVERSAL |  | K Oragne       |  | R-PASMRAR0006 | € 34,95 |
| UNIVERSAL |  | White          |  | R-PASMRBN0006 | € 34,95 |
| UNIVERSAL |  | TM Blue        |  | R-PASMRBLT006 | € 34,95 |
| UNIVERSAL |  | YZ Blue        |  | R-PASMRBL0006 | € 34,95 |
| UNIVERSAL |  | RM Yellow      |  | R-PASMRGI0006 | € 34,95 |
| UNIVERSAL |  | Black          |  | R-PASMRNR0006 | € 34,95 |
| UNIVERSAL |  | CR Red         |  | R-PASMRRS0006 | € 34,95 |
| UNIVERSAL |  | KX Green       |  | R-PASMRVE0006 | € 34,95 |
| UNIVERSAL |  | ☀️ Neon Yellow |  | R-PASMRGF0006 | € 34,95 |
| UNIVERSAL |  | ☀️ Neon Green  |  | R-PASMRVF0006 | € 34,95 |
| UNIVERSAL |  | Quantum Grey   |  | R-PASMRGR0006 | € 34,95 |



Made of polyurethane self-lubricating and provided with bearing.  
Available in different colours.

*Realizzate in poliuretano autolubrificante, fornite con cuscinetto.  
Disponibili in diversi colori*



| BRAND     | MODEL     | CC          | YEAR                   | NOTE                   | COLOR         | CODE          | PRICE   |
|-----------|-----------|-------------|------------------------|------------------------|---------------|---------------|---------|
| UNIVERSAL |           |             |                        | Ø int. 8 mm est. 31 mm | Blue          | R-RSUNIBL0831 | € 19,95 |
|           |           |             |                        | Ø int. 8 mm est. 31 mm | Black         | R-RSUNINR0831 |         |
|           |           |             |                        | Ø int. 8 mm est. 31 mm | Red           | R-RSUNIRS0831 |         |
|           |           |             |                        | Ø int. 8 mm est. 42 mm | Blue          | R-RSUNIBL0842 |         |
|           |           |             |                        | Ø int. 8 mm est. 42 mm | Black         | R-RSUNINR0842 |         |
|           |           |             |                        | Ø int. 8 mm est. 42 mm | Red           | R-RSUNIRS0842 |         |
| HONDA     | CR-CRF-R  | 125 > 450   | 2000 > 2011            | Ø int. 8 mm est. 38 mm | Black         | R-RSCRFNR0838 | € 19,95 |
|           |           |             |                        | Ø int. 8 mm est. 38 mm | Red           | R-RSCRFNR0838 |         |
|           | CRF-R     | 250-450     | 2012 > 2023            | Ø int. 8 mm est. 34 mm | Black         | R-RSCRFNR0012 | € 19,95 |
|           |           |             |                        | Ø int. 8 mm est. 34 mm | Red           | R-RSCRFNR0012 |         |
|           | CRF-RX    | 250         | 2019 > 2023            | Ø int. 8 mm est. 34 mm | Black         | R-RSCRFNR0012 | € 19,95 |
|           |           |             |                        | Ø int. 8 mm est. 34 mm | Red           | R-RSCRFNR0012 |         |
|           | CRF-RX    | 450         | 2017 > 2023            | Ø int. 8 mm est. 34 mm | Black         | R-RSCRFNR0012 | € 19,95 |
|           |           |             |                        | Ø int. 8 mm est. 34 mm | Red           | R-RSCRFNR0012 |         |
|           | CFRX      | 250         | 2004 > 2019            | Ø int. 8 mm est. 38 mm | Black         | R-RSCRFNR0838 | € 19,95 |
|           |           |             |                        | Ø int. 8 mm est. 38 mm | Red           | R-RSCRFNR0838 |         |
|           | CFRX      | 450         | 2005 > 2017            | Ø int. 8 mm est. 38 mm | Black         | R-RSCRFNR0838 | € 19,95 |
|           |           |             |                        | Ø int. 8 mm est. 38 mm | Red           | R-RSCRFNR0838 |         |
|           | CFRX      | 450         | 2019 > 2023            | Ø int. 8 mm est. 34 mm | Black         | R-RSCRFNR0012 | € 19,95 |
|           |           |             |                        | Ø int. 8 mm est. 34 mm | Red           | R-RSCRFNR0012 |         |
| CRF-L     | 450       | 2019 > 2023 | Ø int. 8 mm est. 34 mm | Black                  | R-RSCRFNR0012 | € 19,95       |         |
|           |           |             | Ø int. 8 mm est. 34 mm | Red                    | R-RSCRFNR0012 |               |         |
| KAWASAKI  | KXF/KX-XC | 250-450     | 2007 > 2023            | Ø int. 8 mm est. 38 mm | Black         | R-RSKXFN0838  | € 19,95 |
|           |           |             |                        | Ø int. 8 mm est. 38 mm | Green         | R-RSKXFVE0838 |         |





**Beta  
FACTORY**

## **PROTECTIONS**

- Plastic engine guards >pag 240*
- Aluminum engine guards >pag 244*
- Aluminum engine skid plate >pag 245*
- Radiator side guards >pag 246*
- Disc protectors >pag 248*
- Disc protectors mounting kit >pag 249*
- Swingarm protectors >pag 250*
- Frame protectors >pag 251*
- Monoblock R2.0 Worx Chain guide >pag 254*



### **TECHNOPOLYMER ENGINE GUARD**

- Made by a strong and special technopolymer
- Perfect fitting on the frame of the bike follows also the engine cases
- Total absence of vibrations and extremely quiet operation
- For the non pds models it is possible to add an extra strong slider protection to covers the aluminum linkage part that remains without a shield in the standard louver against ground and stones

### **PARAMOTORE AVVOLGENTE IN TECNOPOLIMERO**

- Realizzato in uno speciale robusto tecnopolimero
- Segue perfettamente la forma del telaio della moto e dei carter motore
- Perfetto fissaggio al telaio della moto
- Totale assenza di vibrazioni e massima silenziosita'
- Per i modelli non pds e' possibile aggiungere una protezione leveraggio extra robusta che ne evita il contatto contro rocce ed ostacoli



Link Protector \*

\* link protector not included - sold separately  
 \* protezione link non inclusa - venduta separatamente



Steel mounting brackets included for models  
 KTM/Husqvarna motocross version 2016 > 2018  
 Staffe supporto incluse per modelli KTM/HUSQVARNA Cross 2016 > 2018

| BRAND           | MODEL                 | CC          | YEAR                         | NOTE                         | COLOR         | CODE          | PRICE   |
|-----------------|-----------------------|-------------|------------------------------|------------------------------|---------------|---------------|---------|
| HONDA           | CRF                   | 250         | 2018 > 2021                  | Link protection NOT INCLUDED | Black         | R-PMCRFNR0017 | € 74,95 |
|                 | CRF / CRF-RX          | 250         | 2022-2023                    | Link protection NOT INCLUDED | CR Red        | R-PMCRFRS0017 | € 74,95 |
|                 | CRF-RX                | 250         | 2019 > 2021                  | Link protection NOT INCLUDED | Black         | R-PMCRFNR0021 | € 74,95 |
|                 |                       |             |                              | Link protection NOT INCLUDED | CR Red        | R-PMCRFRS0021 | € 74,95 |
|                 | CRF / CRF-RX          | 450         | 2017 > 2020                  | Link protection NOT INCLUDED | Black         | R-PMCRFNR0017 | € 74,95 |
|                 | CRF/CRF-RWE/ CRF-RX   | 450         | 2021 > 2023                  | Link protection NOT INCLUDED | CR Red        | R-PMCRFRS0017 | € 74,95 |
|                 |                       |             |                              | Link protection NOT INCLUDED | Black         | R-PMCRFNR0021 | € 74,95 |
| CRFX/ CRF-L     | 450                   | 2019 > 2023 | Link protection NOT INCLUDED | CR Red                       | R-PMCRFRS0017 | € 74,95       |         |
| Link protection | CRF                   | 250         | 2018 > 2021                  | For HONDA*                   | Black         | R-PRTLINK01NR | € 18,95 |
|                 | CRF-RX                | 250         | 2019 > 2021                  | For HONDA*                   | Black         | R-PRTLINK01NR | € 18,95 |
|                 | CRF / CRF-RX          | 250         | 2022-2023                    | For HONDA*                   | Black         | R-PRTLINK01NR | € 18,95 |
|                 | CRF / CRF-RX          | 450         | 2017 > 2020                  | For HONDA*                   | Black         | R-PRTLINK01NR | € 18,95 |
|                 | CRF/ CRF-RX / CRF-RWE | 450         | 2021 > 2023                  | For HONDA*                   | Black         | R-PRTLINK01NR | € 18,95 |
|                 | CRFX/ CRF-L           | 450         | 2019 > 2023                  | For HONDA*                   | Black         | R-PRTLINK01NR | € 18,95 |

\* Link protection mounting screws included

# PROTECTIONS-PROTEZIONI TECHNOLYMER ENGINE GUARD / PARAMOTORE IN TECNOPOLIMERO

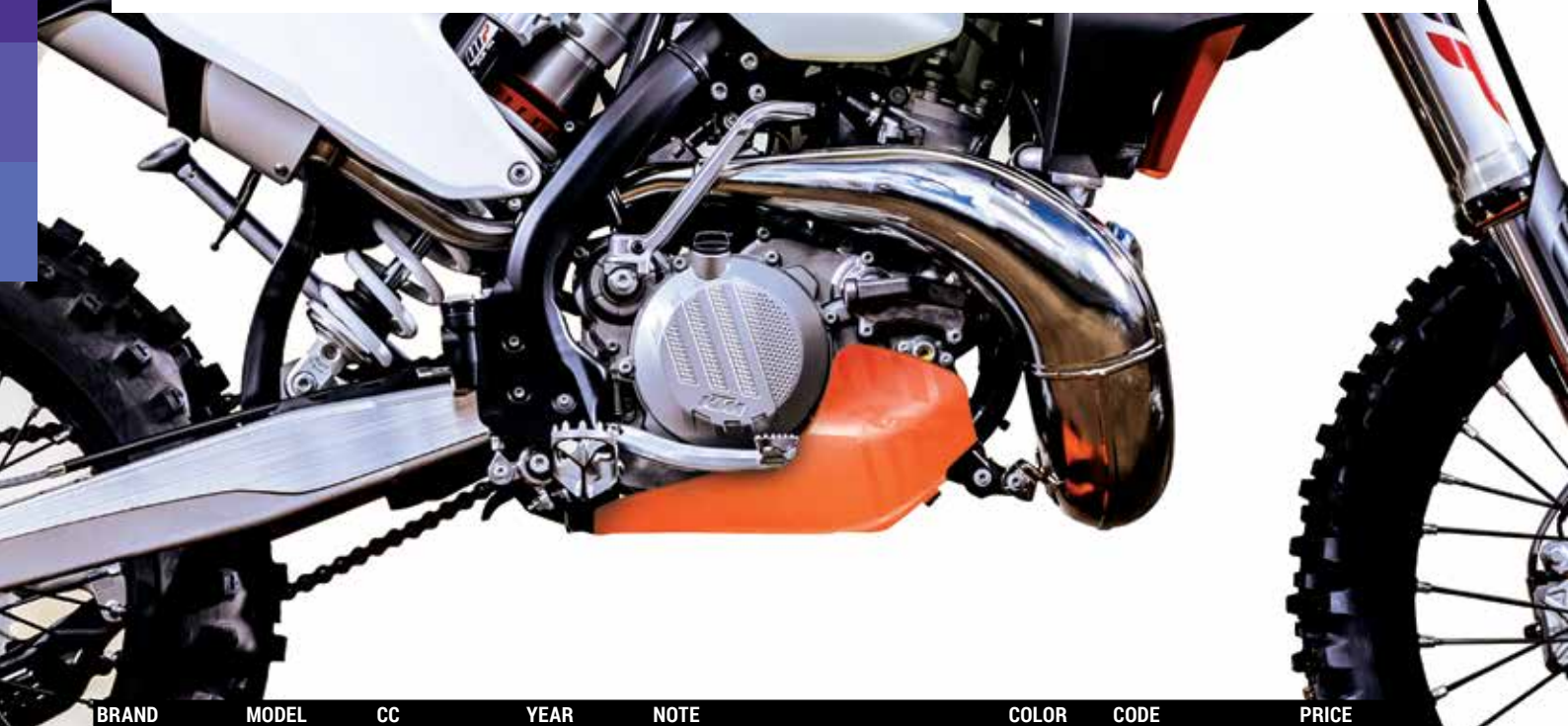

| BRAND           | MODEL           | CC              | YEAR                         | NOTE                         | COLOR         | CODE          | PRICE         |
|-----------------|-----------------|-----------------|------------------------------|------------------------------|---------------|---------------|---------------|
| YAMAHA          | YZ / YZ-X       | 125             | 2005 > 2023                  | Link protection NOT INCLUDED | Black         | R-PMYZ0NR0125 | € 74,95       |
|                 | YZ / YZ-X       | 250             | 2005 > 2023                  | Link protection NOT INCLUDED | Black         | R-PMYZ0NR0250 | € 74,95       |
|                 | YZF             | 250             | 2019 > 2023                  | Link protection NOT INCLUDED | Black         | R-PMYZFNR0018 | € 74,95       |
|                 | YZ-FX           | 250             | 2020 > 2023                  | Link protection NOT INCLUDED | Black         | R-PMYZFNR0018 | € 74,95       |
|                 | YZF             | 450             | 2018 > 2022                  | Link protection NOT INCLUDED | Black         | R-PMYZFNR0018 | € 74,95       |
|                 | YZF             | 450             | 2023                         | Link protection NOT INCLUDED | Black         | R-PMYZFNR0023 | € 74,95       |
|                 | YZ-FX           | 450             | 2019 > 2023                  | Link protection NOT INCLUDED | Black         | R-PMYZFNR0018 | € 74,95       |
|                 | WRF             | 250             | 2020 > 2023                  | Link protection NOT INCLUDED | Black         | R-PMYZFNR0018 | € 74,95       |
|                 | WRF             | 450             | 2019 > 2023                  | Link protection NOT INCLUDED | Black         | R-PMYZFNR0018 | € 74,95       |
|                 | Link protection | YZ              | 125-250                      | 2005 > 2023                  | For YAMAHA*   | Black         | R-PRTLINK01NR |
| YZF             |                 | 250             | 2019 > 2023                  | For YAMAHA*                  | Black         | R-PRTLINK02NR | € 18,95       |
| YZ-FX           |                 | 250             | 2020 > 2023                  | For YAMAHA*                  | Black         | R-PRTLINK02NR | € 18,95       |
| YZF             |                 | 450             | 2018 > 2023                  | For YAMAHA*                  | Black         | R-PRTLINK02NR | € 18,95       |
| YZ-FX           |                 | 450             | 2019 > 2023                  | For YAMAHA*                  | Black         | R-PRTLINK02NR | € 18,95       |
| WRF             |                 | 250             | 2020 > 2023                  | For YAMAHA*                  | Black         | R-PRTLINK02NR | € 18,95       |
| WRF             |                 | 450             | 2019 > 2023                  | For YAMAHA*                  | Black         | R-PRTLINK02NR | € 18,95       |
| KAWASAKI        | KX              | 250             | 2021 > 2023                  | Link protection NOT INCLUDED | Black         | R-PMKX0NR0021 | € 74,95       |
|                 | KX-XC           | 250-450         | 2021 > 2023                  | Link protection NOT INCLUDED | Black         | R-PMKX0NR0021 | € 74,95       |
|                 | KX              | 450             | 2020 > 2023                  | Link protection NOT INCLUDED | Black         | R-PMKX0NR0021 | € 74,95       |
| Link protection | KX              | 250             | 2021 > 2023                  | For Kawasaki*                | Black         | R-PRTLINK02NR | € 18,95       |
|                 | KX-XC           | 250-450         | 2021 > 2023                  | For Kawasaki*                | Black         | R-PRTLINK02NR | € 18,95       |
|                 | KX              | 450             | 2020 > 2023                  | For Kawasaki*                | Black         | R-PRTLINK02NR | € 18,95       |
| KTM             | SX              | 125             | 2016 > 2022                  | Link protection NOT INCLUDED | K Orange      | R-PMKTMAR0125 | € 74,95       |
|                 |                 |                 |                              | Link protection NOT INCLUDED | Black         | R-PMKTMNR0125 | € 74,95       |
|                 | XC-W            | 125-150         | 2017 > 2019                  | Link protection NOT INCLUDED | K Orange      | R-PMKTMAR0125 | € 74,95       |
|                 |                 |                 |                              | Link protection NOT INCLUDED | Black         | R-PMKTMNR0125 | € 74,95       |
|                 | XC-W-TPI        | 150             | 2020 > 2023                  | Link protection NOT INCLUDED | K Orange      | R-PMKTMAR0150 | € 74,95       |
|                 |                 |                 |                              | Link protection NOT INCLUDED | Black         | R-PMKTMNR0150 | € 74,95       |
|                 | SXF             | 250-350         | 2016 > 2018                  | Link protection NOT INCLUDED | K Orange      | R-PMKTMAR2518 | € 74,95       |
|                 |                 |                 |                              | Link protection NOT INCLUDED | Black         | R-PMKTMNR2518 | € 74,95       |
|                 | EXCF            | 250-350         | 2017 > 2023                  | Link protection NOT INCLUDED | K Orange      | R-PMKTMAR2518 | € 74,95       |
|                 |                 |                 |                              | Link protection NOT INCLUDED | Black         | R-PMKTMNR2518 | € 74,95       |
|                 | EXCF            | 450-500         | 2017 > 2023                  | Link protection NOT INCLUDED | K Orange      | R-PMKTMAR4518 | € 74,95       |
|                 |                 |                 |                              | Link protection NOT INCLUDED | Black         | R-PMKTMNR4518 | € 74,95       |
|                 | SX              | 250             | 2017 > 2022                  | Link protection NOT INCLUDED | K Orange      | R-PMKTMAR3018 | € 74,95       |
|                 |                 |                 |                              | Link protection NOT INCLUDED | Black         | R-PMKTMNR3018 | € 74,95       |
|                 | EXC/XC-W        | 250-300         | 2017 > 2023                  | Link protection NOT INCLUDED | K Orange      | R-PMKTMAR3018 | € 74,95       |
|                 |                 |                 | Link protection NOT INCLUDED | Black                        | R-PMKTMNR3018 | € 74,95       |               |
| SXF/XC-F        | 250-350         | 2019 > 2022     | Link protection NOT INCLUDED | K Orange                     | R-PMKTMAR2519 | € 74,95       |               |
|                 |                 |                 | Link protection NOT INCLUDED | Black                        | R-PMKTMNR2519 | € 74,95       |               |
| SXF             | 450             | 2016 > 2018     | Link protection NOT INCLUDED | K Orange                     | R-PMKTMAR4518 | € 74,95       |               |
|                 |                 |                 | Link protection NOT INCLUDED | Black                        | R-PMKTMNR4518 | € 74,95       |               |
| SXF/XC-F        | 450             | 2019 > 2022     | Link protection NOT INCLUDED | K Orange                     | R-PMKTMAR4519 | € 74,95       |               |
|                 |                 |                 | Link protection NOT INCLUDED | Black                        | R-PMKTMNR4519 | € 74,95       |               |
| Link protection | SX-SXF-XC       | 125-250-350-450 | 2016 > 2023                  | For KTM*                     | Black         | R-PRTLINK02NR | € 18,95       |

\* Link protection mounting screws included

# PROTECTIONS-PROTEZIONI ALUMINUM ENGINE GUARD / PARAMOTORE AVVOLGENTE IN ALLUMINIO



| BRAND           | MODEL           | CC                  | YEAR                         | NOTE                         | COLOR         | CODE          | PRICE   |
|-----------------|-----------------|---------------------|------------------------------|------------------------------|---------------|---------------|---------|
| HUSQVARNA       | TC              | 125                 | 2016 > 2022                  | Link protection NOT INCLUDED | Black         | R-PMKTMNR0125 | € 74,95 |
|                 | TE / TX         | 125-150             | 2017 > 2019                  | Link protection NOT INCLUDED | Black         | R-PMKTMNR0125 | € 74,95 |
|                 | TE-I            | 150                 | 2020 > 2023                  | Link protection NOT INCLUDED | Black         | R-PMKTMNR0150 | € 74,95 |
|                 | FC              | 250-350             | 2016 > 2018                  | Link protection NOT INCLUDED | HSQ Yellow    | R-PMKTMGQ2518 | € 74,95 |
|                 |                 |                     |                              | Link protection NOT INCLUDED | Black         | R-PMKTMNR2518 |         |
|                 | FC/FX           | 250-350             | 2019 > 2022                  | Link protection NOT INCLUDED | HSQ Yellow    | R-PMKTMGQ2519 | € 74,95 |
|                 |                 |                     |                              | Link protection NOT INCLUDED | Black         | R-PMKTMNR2519 |         |
|                 | FC              | 450                 | 2016 > 2018                  | Link protection NOT INCLUDED | HSQ Yellow    | R-PMKTMGQ4518 | € 74,95 |
|                 |                 |                     |                              | Link protection NOT INCLUDED | Black         | R-PMKTMNR4518 |         |
|                 | FC/FX           | 450                 | 2019 > 2023                  | Link protection NOT INCLUDED | HSQ Yellow    | R-PMKTMGQ4519 | € 74,95 |
|                 |                 |                     |                              | Link protection NOT INCLUDED | Black         | R-PMKTMNR4519 |         |
|                 | FE              | 250-350             | 2017 > 2023                  | Link protection NOT INCLUDED | HSQ Yellow    | R-PMKTMGQ2518 | € 74,95 |
|                 |                 |                     |                              | Link protection NOT INCLUDED | Black         | R-PMKTMNR2518 |         |
|                 | TC              | 250                 | 2017 > 2022                  | Link protection NOT INCLUDED | HSQ Yellow    | R-PMKTMGQ3018 | € 74,95 |
|                 |                 |                     | Link protection NOT INCLUDED | Black                        | R-PMKTMNR3018 |               |         |
| TE-TX           | 250-300         | 2017 > 2023         | Link protection NOT INCLUDED | HSQ Yellow                   | R-PMKTMGQ3018 | € 74,95       |         |
|                 |                 |                     | Link protection NOT INCLUDED | Black                        | R-PMKTMNR3018 |               |         |
| FE/FX/FS        | 450-500         | 2017 > 2023         | Link protection NOT INCLUDED | HSQ Yellow                   | R-PMKTMGQ4518 | € 74,95       |         |
|                 |                 |                     | Link protection NOT INCLUDED | Black                        | R-PMKTMNR4518 |               |         |
| Link protection | FC              | 450                 | 2016 > 2023                  | For HUSQVARNA*               | Black         | R-PRTLINK02NR | € 18,95 |
|                 | FE-FS-FX        | 450-500             | 2017 > 2023                  | For HUSQVARNA*               | Black         | R-PRTLINK02NR | € 18,95 |
| GAS GAS         | MC              | 125                 | 2021 > 2023                  | Link protection NOT INCLUDED | Black         | R-PMKTMNR0125 | € 74,95 |
|                 | EC              | 250-300             | 2021 > 2023                  | Link protection NOT INCLUDED | Black         | R-PMKTMNR3018 | € 74,95 |
|                 | MC-F            | 250                 | 2021 > 2023                  | Link protection NOT INCLUDED | Black         | R-PMKTMNR2519 | € 74,95 |
|                 | EC-F            | 250-350             | 2021 > 2023                  | Link protection NOT INCLUDED | Black         | R-PMKTMNR2519 | € 74,95 |
|                 | MC-F            | 450                 | 2021 > 2023                  | Link protection NOT INCLUDED | Black         | R-PMKTMNR4519 | € 74,95 |
| Link protection | MC/MC-F/EC/EC-F | 125-250-300-350-450 | 2021 > 2023                  | For GAS GAS*                 | Black         | R-PRTLINK02NR | € 18,95 |
| BETA            | RR              | 250-300             | 2013 > 2019                  | Link protection NOT INCLUDED | Black         | R-PMBETNR3019 | € 74,95 |
|                 | RR              | 250-300             | 2020 > 2023                  | Link protection NOT INCLUDED | Black         | R-PMBETNR3020 | € 74,95 |
|                 |                 |                     |                              |                              | CR Red        | R-PMBETRS3020 |         |
|                 | RR              | 350 > 530           | 2020 > 2023                  | Link protection NOT INCLUDED | Black         | R-PMBETNR4520 | € 74,95 |
|                 |                 |                     |                              | CR Red                       | R-PMBETRS4520 |               |         |
|                 | X-TRAINER       | 250-300             | 2015 > 2023                  | Link protection NOT INCLUDED | Black         | R-PMBETNR3019 | € 74,95 |
| Link protection | RR              | 250-300             | 2013 > 2023                  | For BETA*                    | Black         | R-PRTLINK02NR | € 18,95 |
|                 | RR              | 350 > 530           | 2011 > 2023                  | For BETA*                    | Black         | R-PRTLINK02NR | € 18,95 |
|                 | X-TRAINER       | 250-300             | 2015 > 2023                  | For BETA*                    | Black         | R-PRTLINK02NR | € 18,95 |
| FANTIC          | XX / XE         | 125                 | 2021 > 2023                  | Link protection NOT INCLUDED | Black         | R-PMYZ0NR0125 | € 74,95 |
|                 | XX / XE         | 250                 | 2021 > 2023                  | Link protection NOT INCLUDED | Black         | R-PMYZ0NR0250 | € 74,95 |
|                 | XXF / XEF       | 250                 | 2021 > 2023                  | Link protection NOT INCLUDED | Black         | R-PMYZFN0018  | € 74,95 |
|                 | XXF             | 450                 | 2021 > 2022                  | Link protection NOT INCLUDED | Black         | R-PMYZFN0018  | € 74,95 |
|                 | XXF             | 450                 | 2023                         | Link protection NOT INCLUDED | Black         | R-PMYZFN0023  | € 74,95 |
|                 | XE              | 450                 | 2021 > 2023                  | Link protection NOT INCLUDED | Black         | R-PMYZFN0018  | € 74,95 |
|                 |                 |                     |                              |                              | Black         | R-PMYZFN0018  | € 74,95 |
| Link protection | XX / XE         | 125-250-450         | 2021 > 2023                  | For FANTIC*                  | Black         | R-PRTLINK01NR | € 18,95 |
|                 | XXF / XEF       | 125-250-450         | 2021 > 2023                  | For FANTIC*                  | Black         | R-PRTLINK02NR | € 18,95 |

\* Link protection mounting screws included



**FULL WRAP ALUMINUM ENGINE GUARD**

Encircling aluminum engine guard, extremely strength and low weight, fully hand welded with TIG technology.

**PARAMOTORE AVVOLGENTE IN ALLUMINIO**

Paramotore avvolgente in alluminio dall'estrema robustezza e peso contenuto. Saldato interamente a mano con tecnologia a TIG.

| BRAND     | MODEL        | CC              | YEAR        | COLOR       | CODE           | PRICE         |
|-----------|--------------|-----------------|-------------|-------------|----------------|---------------|
| HONDA     | CRF          | 250             | 2010 > 2013 | Silver      | R-PMCRF2AVV10  | € 137,95      |
|           | CRF          | 250             | 2014 > 2017 | Silver      | R-PMCRF2AVV14  | € 137,95      |
|           | CRF          | 250             | 2018 > 2021 | Silver      | R-PMCRF2AVV17  | € 137,95      |
|           | CRFX         | 250             | 2004 > 2017 | Silver      | R-PMCRFX00405  | € 137,95      |
|           | CRF-RX       | 250             | 2019 > 2021 | Silver      | R-PMCRF2AVV17  | € 137,95      |
|           | CRF          | 450             | 2009 > 2016 | Silver      | R-PMCRF4AVV09  | € 137,95      |
|           | CRFX         | 450             | 2005 > 2017 | Silver      | R-PMCRF400005  | € 137,95      |
|           | CRF / CRF-RX | 450             | 2017 > 2020 | Silver      | R-PMCRF2AVV17  | € 137,95      |
|           | CRFX/CRF-L   | 450             | 2019 > 2023 | Silver      | R-PMCRF2AVV17  | € 137,95      |
|           | YAMAHA       | WRF             | 250         | 2015 > 2019 | Silver         | R-PMYZF2AVV14 |
| WRF       |              | 450             | 2012 > 2015 | Silver      | R-PMWRF4AVV12  | € 137,95      |
| WRF       |              | 450             | 2016 > 2018 | Silver      | R-PMWRF4AVV16  | € 137,95      |
| YZF       |              | 250             | 2014 > 2018 | Silver      | R-PMYZF2AVV14  | € 137,95      |
| YZF       |              | 450             | 2010 > 2013 | Silver      | R-PMYZF4AVV10  | € 137,95      |
| YZF       |              | 450             | 2014 > 2017 | Silver      | R-PMYZF4AVV14  | € 137,95      |
| YZF       |              | 450             | 2018 > 2022 | Silver      | R-PMYZF4AVV18  | € 137,95      |
| KAWASAKI  | YZF          | 250             | 2019 > 2023 | Silver      | R-PMYZF4AVV18  | € 137,95      |
|           | KXF          | 250             | 2009 > 2016 | Silver      | R-PMKXF2AVV09  | € 137,95      |
|           | KXF          | 250             | 2017 > 2019 | Silver      | R-PMKXF2AVV17  | € 137,95      |
| SUZUKI    | KXF          | 450             | 2016 > 2018 | Silver      | R-PMKXF4AVV16  | € 137,95      |
|           | RMZ          | 250             | 2010 > 2018 | Silver      | R-PMRMZ2AVV10  | € 137,95      |
|           | RMZ          | 450             | 2010 > 2017 | Silver      | R-PMRMZ4AVV11  | € 137,95      |
| KTM       | RMZ          | 450             | 2018 > 2023 | Silver      | R-PMRMZ4AVV18  | € 137,95      |
|           | EXC          | 125-200         | 2004 > 2016 | Silver      | R-PMKTM200004  | € 137,95      |
|           | EXC          | 250-300         | 2004 > 2016 | Silver      | R-PMKTM200024  | € 137,95      |
|           | EXC/XCW      | 250-300         | 2017 > 2023 | Silver      | R-PMKTM300A17  | € 137,95      |
|           | EXCF         | 250-350         | 2017 > 2023 | Silver      | R-PMKTM250A16  | € 137,95      |
|           | EXCF         | 400-450-530     | 2008 > 2011 | Silver      | R-PMKTMEXCF48  | € 137,95      |
|           | EXCF         | 450-500         | 2017 > 2023 | Silver      | R-PMKTM450A16  | € 137,95      |
|           | SX           | 125             | 2004 > 2015 | Silver      | R-PMKTM200004  | € 137,95      |
|           | SX           | 125-150         | 2016 > 2018 | Silver      | R-PMKTM125A16  | € 137,95      |
|           | SX           | 250             | 2004 > 2016 | Silver      | R-PMKTM200024  | € 137,95      |
|           | SX           | 250             | 2017-2018   | Silver      | R-PMKTM300A17  | € 137,95      |
|           | SX           | 450-525         | 2004 > 2006 | Silver      | R-PMKTM200024  | € 137,95      |
|           | SXF          | 250-350         | 2016 > 2018 | Silver      | R-PMKTM250A16  | € 137,95      |
|           | SXF          | 450             | 2016 > 2018 | Silver      | R-PMKTM450A16  | € 137,95      |
| HUSQVARNA | XC-W         | 125-150         | 2017 > 2023 | Silver      | R-PMKTM125A16  | € 137,95      |
|           | TE           | 125             | 2014 > 2016 | Silver      | R-PMKTM200004  | € 137,95      |
|           | TE           | 250-300         | 2014 > 2016 | Silver      | R-PMKTM200024  | € 137,95      |
|           | TE/TX        | 250-300         | 2017 > 2023 | Silver      | R-PMKTM300A17  | € 137,95      |
|           | TC           | 125             | 2014-2015   | Silver      | R-PMKTM200004  | € 137,95      |
|           | TC           | 125             | 2016 > 2018 | Silver      | R-PMKTM125A16  | € 137,95      |
|           | TC           | 250             | 2014 > 2016 | Silver      | R-PMKTM200024  | € 137,95      |
|           | TC           | 250             | 2017 > 2019 | Silver      | R-PMKTM300A17  | € 137,95      |
|           | TX           | 125-150         | 2017 > 2023 | Silver      | R-PMKTM125A16  | € 137,95      |
|           | FE           | 250-350         | 2017 > 2023 | Silver      | R-PMKTM250A16  | € 137,95      |
|           | FE / FS / FX | 450-501         | 2017 > 2023 | Silver      | R-PMKTM450A16  | € 137,95      |
|           | FC           | 250-350         | 2016 > 2018 | Silver      | R-PMKTM250A16  | € 137,95      |
|           | FC           | 450             | 2016 > 2018 | Silver      | R-PMKTM450A16  | € 137,95      |
|           | HUSABERG     | TE              | 125         | 2013-2014   | Silver         | R-PMKTM200004 |
| TE        |              | 250-300         | 2013-2014   | Silver      | R-PMKTM200024  | € 137,95      |
| BETA      | RR           | 250-300         | 2013 > 2019 | Silver      | R-PMBETA2T013  | € 137,95      |
|           | RR           | 350-400-450-530 | 2011 > 2019 | Silver      | R-PMBETA00010  | € 137,95      |
| SHERCO    | SE           | 250-300         | 2014 > 2016 | Silver      | R-PMSHE02T0014 | € 137,95      |
|           | SEF          | 250-300-450     | 2012 > 2016 | Silver      | R-PMSHE04T0014 | € 137,95      |
| GAS GAS   | EC           | 200-250-300     | 2012 > 2020 | Silver      | R-PMGAS2AVV12  | € 137,95      |

## PROTECTIONS-PROTEZIONI ALUMINUM ENGINE SKID PLATE / SLITTA PARAMOTORE IN ALLUMINIO

Aluminum engine skid plate,  
extremely strenght and light weight.

*Slitta paramotore in alluminio  
estremamente resistente e leggera.*



**R-PMCRF2SLI10**

| BRAND            | MODEL        | CC      | YEAR        | COLOR  | CODE                 | PRICE   |
|------------------|--------------|---------|-------------|--------|----------------------|---------|
| <b>HONDA</b>     | CRF          | 250     | 2014 > 2017 | Silver | <b>R-PMCRF2SLI14</b> | € 83,95 |
|                  | CRF / CRF-RX | 450     | 2017-2018   | Silver | <b>R-PMCRF4SLI17</b> | € 83,95 |
| <b>YAMAHA</b>    | YZF          | 250     | 2014 > 2018 | Silver | <b>R-PMYZF2SLI14</b> | € 83,95 |
|                  | YZF          | 450     | 2014 > 2017 | Silver | <b>R-PMYZF4SLI14</b> | € 83,95 |
| <b>SUZUKI</b>    | RMZ          | 450     | 2010 > 2017 | Silver | <b>R-PMRMZ4SLI10</b> | € 83,95 |
| <b>KTM</b>       | SX           | 125-150 | 2016 > 2018 | Silver | <b>R-PMKTM125S16</b> | € 83,95 |
|                  | SXF          | 250-350 | 2016 > 2018 | Silver | <b>R-PMKTM250S16</b> | € 83,95 |
|                  | EXCF         | 250-350 | 2017 > 2023 | Silver | <b>R-PMKTM250S16</b> | € 83,95 |
|                  | XC-W         | 125-250 | 2017 > 2023 | Silver | <b>R-PMKTM125S16</b> | € 83,95 |
| <b>HUSQVARNA</b> | TC           | 125     | 2016 > 2018 | Silver | <b>R-PMKTM125S16</b> | € 83,95 |
|                  | TX           | 125-150 | 2017 > 2023 | Silver | <b>R-PMKTM125S16</b> | € 83,95 |
|                  | FC           | 250-350 | 2016 > 2018 | Silver | <b>R-PMKTM250S16</b> | € 83,95 |
|                  | FE           | 250-350 | 2017 > 2023 | Silver | <b>R-PMKTM250S16</b> | € 83,95 |





## RADIATOR SIDE GUARDS / PROTEZIONI RADIATORE

Made of strong light alloy aluminium follows perfectly the shape of radiator  
*Realizzato in lega di alluminio, segue perfettamente la forma del radiatore*

| BRAND     | MODEL          | CC      | YEAR        | COLOR       | CODE        | PRICE       |
|-----------|----------------|---------|-------------|-------------|-------------|-------------|
| HONDA     | CRF            | 250     | 2006 > 2009 | Silver      | PARADCRF008 | € 104,95    |
|           | CRF            | 250     | 2010 > 2013 | Silver      | PARADCRF010 | € 104,95    |
|           | CRF            | 250     | 2014 > 2015 | Silver      | PARADCRF014 | € 104,95    |
|           | CRF            | 250     | 2018 > 2021 | Silver      | PARADCRF018 | € 104,95    |
|           | CRF / CRF-RX   | 250     | 2022-2023   | Silver      | PARADCRF021 | € 104,95    |
|           | CRF-RX         | 250     | 2019 > 2021 | Silver      | PARADCRF018 | € 104,95    |
|           | CRFX           | 250     | 2004 > 2019 | Silver      | PARADCRFX08 | € 104,95    |
|           | CRF            | 450     | 2015-2016   | Silver      | PARADCRF015 | € 104,95    |
|           | CRF-R          | 450     | 2017 > 2020 | Silver      | PARADCRF017 | € 104,95    |
|           | CRF-RX         | 450     | 2017 > 2020 | Silver      | PARADCRF017 | € 104,95    |
|           | CRF-R / CRF-RX | 450     | 2021-2022   | Silver      | PARADCRF021 | € 104,95    |
|           | YAMAHA         | WRF     | 250         | 2015 > 2019 | Silver      | PARADWRF215 |
| WRF       |                | 450     | 2016 > 2018 | Silver      | PARADWRF215 | € 104,95    |
| YZ / YZ-X |                | 125-250 | 2008 > 2023 | Silver      | PARADYZ0077 | € 104,95    |
| YZ-FX     |                | 250     | 2020 > 2023 | Silver      | PARADYZF458 | € 104,95    |
| YZF       |                | 250     | 2014 > 2018 | Silver      | PARADYZF454 | € 104,95    |
| YZF       |                | 250     | 2019 > 2023 | Silver      | PARADYZF458 | € 104,95    |
| YZ-FX     |                | 450     | 2019 > 2023 | Silver      | PARADYZF458 | € 104,95    |
| YZF       |                | 450     | 2014 > 2017 | Silver      | PARADYZF454 | € 104,95    |
| YZF       |                | 450     | 2018 > 2022 | Silver      | PARADYZF458 | € 104,95    |
| YZF       |                | 450     | 2023        | Silver      | PARADYZF423 | € 104,95    |
| KAWASAKI  | KXF            | 250     | 2017 > 2020 | Silver      | PARADKXF017 | € 104,95    |
|           | KXF            | 250     | 2021 > 2023 | Silver      | PARADKXF019 | € 104,95    |
|           | KXF            | 450     | 2016 > 2018 | Silver      | PARADKXF016 | € 104,95    |
|           | KXF            | 450     | 2019 > 2023 | Silver      | PARADKXF019 | € 104,95    |
|           | KX-XC          | 250-450 | 2021 > 2023 | Silver      | PARADKXF019 | € 104,95    |
| SUZUKI    | RMZ            | 250     | 2010 > 2018 | Silver      | PARADRMZ250 | € 104,95    |
|           | RMZ            | 450     | 2018 > 2023 | Silver      | PARADRMZ458 | € 104,95    |



PARADKTM016



PARADYZF458

## PROTECTIONS-PROTEZIONI RADIATOR SIDE GUARD / PROTEZIONE RADIATORE

| BRAND               | MODEL  | CC                      | YEAR                    | COLOR       | CODE         | PRICE       |          |
|---------------------|--|-------------------------|-------------------------|-------------|--------------|-------------|----------|
| <b>KTM</b>          | EXC  | 125-200-250-300         | 2008 > 2016             | Silver      | PARADKTM097  | € 104,95    |          |
|                     | EXCF   | 250-400-450-500-530     | 2008 > 2016             | Silver      | PARADKTM097  | € 104,95    |          |
|                     | EXC  | 250-300                 | 2017 > 2023             | Silver      | PARADKTM016  | € 104,95    |          |
|                     | EXCF / SIX DAYS for all models with electric fun | 250-350-450-500         | 2012 > 2016             | Silver      | PARADKTM012  | € 104,95    |          |
|                     | EXCF / SIX DAYS                                  | 250-350-450-500         | 2017 > 2023             | Silver      | PARADKTM017  | € 104,95    |          |
|                     | SX   | 125-144-150             | 2007 > 2015             | Silver      | PARADKTM097  | € 104,95    |          |
|                     | SX   | 250                     | 2007 > 2016             | Silver      | PARADKTM097  | € 104,95    |          |
|                     | SX   | 250                     | 2017 > 2022             | Silver      | PARADKTM016  | € 104,95    |          |
|                     | SX   | 125-150                 | 2016 > 2022             | Silver      | PARADKTM016  | € 104,95    |          |
|                     | SX   | 125-250-300             | 2023                    | Silver      | PARADKTM023  | € 104,95    |          |
|                     | SXF  | 250-350-450-505         | 2007 > 2015             | Silver      | PARADKTM097  | € 104,95    |          |
|                     | SXF  | 250-350-450             | 2016 > 2022             | Silver      | PARADKTM016  | € 104,95    |          |
|                     | SXF  | 250-350-450             | 2023                    | Silver      | PARADKTM023  | € 104,95    |          |
|                     | SXF  | 250-450 FACTORY EDITION | 2022                    | Silver      | PARADKTM023  | € 104,95    |          |
|                     | XC-W   | 125-150-250-300         | 2017 > 2023             | Silver      | PARADKTM016  | € 104,95    |          |
|                     | XC   | 125-150-250-300         | 2023                    | Silver      | PARADKTM023  | € 104,95    |          |
|                     | XC-F   | 250-350-450             | 2023                    | Silver      | PARADKTM023  | € 104,95    |          |
|                     | <b>HUSABERG<br/>HUSQVARNA</b>                    | TE-FE                   | 125-250-300-350-450-501 | 2013-2014   | Silver       | PARADKTM012 | € 104,95 |
| TC                  |  | 125                     | 2016 > 2022             | Silver      | PARADKTM016  | € 104,95    |          |
| TC                  |  | 125-250-300             | 2023                    | Silver      | PARADKTM023  | € 104,95    |          |
| TC / TE             |  | 310-450-510             | 2008 > 2010             | Silver      | PARADHSQ055  | € 104,95    |          |
| TE / FE             |  | 125-250-300-350-450-501 | 2014 > 2016             | Silver      | PARADKTM012  | € 104,95    |          |
| FE                  |  | 250-350-450-501         | 2017 > 2023             | Silver      | PARADKTM017  | € 104,95    |          |
| TC                  |  | 250                     | 2017 > 2022             | Silver      | PARADKTM016  | € 104,95    |          |
| TE                  |  | 250                     | 2008 > 2009             | Silver      | PARADHSQ055  | € 104,95    |          |
| TE                  |  | 150-250-300             | 2017 > 2023             | Silver      | PARADKTM016  | € 104,95    |          |
| TX                  |  | 125-250-300             | 2017 > 2022             | Silver      | PARADKTM016  | € 104,95    |          |
| TX                  |  | 300-350-450             | 2023                    | Silver      | PARADKTM023  | € 104,95    |          |
| TC / FC             |  | 125-250-350-450         | 2014-2015               | Silver      | PARADKTM012  | € 104,95    |          |
| FC / FS             |  | 250-350-450             | 2016 > 2022             | Silver      | PARADKTM016  | € 104,95    |          |
| FC / FX             |  | 250-350-450             | 2023                    | Silver      | PARADKTM023  | € 104,95    |          |
| FC Rockstar Edition |  | 250-450                 | 2022                    | Silver      | PARADKTM023  | € 104,95    |          |
| <b>GAS-GAS</b>      |  | EC                      | 125-250-300             | 2012 > 2023 | Silver       | PARADGAS002 | € 104,95 |
|                     |  | EC-ECF                  | 250-300-350             | 2021 > 2023 | Silver       | PARADKTM016 | € 104,95 |
|                     |  | MC-MCF                  | 125-250-450             | 2021 > 2023 | Silver       | PARADKTM016 | € 104,95 |
| <b>BETA</b>         | RR   | 250 > 530               | 2005 > 2019             | Silver      | PARADBET001  | € 104,95    |          |
|                     | X-TRAINER  | 300                     | 2016 > 2023             | Silver      | PARADBET001  | € 104,95    |          |
|                     | RR   | 125 > 480               | 2020 > 2023             | Silver      | PARADBET002  | € 104,95    |          |
| <b>TM</b>           | MXF / ENF / SMR                                  | 450-530 (4t)            | 2015 > 2023             | Silver      | PARADTM4T15  | € 104,95    |          |
|                     | MX / EN  | 125-144 (2t)            | 2015 > 2023             | Silver      | PARADTM2T151 | € 104,95    |          |
|                     | EN / MX  | 250-300 (2t)            | 2015 > 2023             | Silver      | PARADTM2T15  | € 104,95    |          |
| <b>SHERCO</b>       | SE / SEF   | 250-300-450             | 2014 > 2016             | Silver      | PARADSHE016  | € 104,95    |          |





### TECHNOPOLYMER DISC PROTECTOR

Made by technopolymer, protective and streamlined, airflow holes, comes with IPL graphic deco co-injected. Needs specific mounting kit (not included).

### PROTEZIONI FRENO A DISCO UNIVERSALE IN TECNOPOLIMERO

In tecnopolimero, dalla linea filante, dotato di fori per aerazione, realizzato con grafica ultrasensibile co-stampata IPL. Necessita di kit di montaggio



R-DISCPBTN000



R-DISCPNTR000



R-DISCPTRS000



R-DISCPBL000



R-DISCPGTI000



R-DISCPGF000



R-DISCPVE000



R-DISCPAN000



| BRAND     | NOTE                      | COLOR       | CODE          | PRICE   |
|-----------|---------------------------|-------------|---------------|---------|
| Universal | Mounting kit not included | White       | R-DISCPBTN000 | € 26,95 |
| Universal | Mounting kit not included | Black       | R-DISCPNTR000 | € 26,95 |
| Universal | Mounting kit not included | CR Red      | R-DISCPTRS000 | € 26,95 |
| Universal | Mounting kit not included | YZ Blue     | R-DISCPBL000  | € 26,95 |
| Universal | Mounting kit not included | RM Yellow   | R-DISCPGTI000 | € 26,95 |
| Universal | Mounting kit not included | Neon Yellow | R-DISCPGF000  | € 26,95 |
| Universal | Mounting kit not included | KX Verde    | R-DISCPVE000  | € 26,95 |
| Universal | Mounting kit not included | K Orange    | R-DISCPAN000  | € 26,95 |
| Universal | Mounting kit not included | Neon Orange | R-DISCPAN000  | € 26,95 |

## PROTECTIONS-PROTEZIONI DISC PROTECTOR / PROTEZIONE FRENO ANTERIORE

### DISC PROTECTOR MOUNTING KIT / KIT DI MONTAGGIO PROTEZIONI DISCO

Made in light alloy aluminum and stainless steel by **CNC** machinery, specific for each model.

Realizzato a **CNC** in lega leggera di alluminio e acciaio Inox, specifico per ogni modello.



| BRAND            | MODEL                           | CC                  | YEAR        | COLOR    | CODE                 | PRICE   |
|------------------|---------------------------------|---------------------|-------------|----------|----------------------|---------|
| <b>HONDA</b>     | CR/CRF-R/CRF-RX/<br>/CRFX/CRF-L | 125-250-450         | 2004 > 2023 | Aluminum | <b>R-KITMOUNT100</b> | € 43,95 |
| <b>YAMAHA</b>    | YZ                              | 125-250             | 2004 > 2023 | Aluminum | <b>R-KITMOUNT103</b> | € 43,95 |
|                  | YZ-X                            | 125                 | 2020 > 2023 | Aluminum | <b>R-KITMOUNT103</b> | € 43,95 |
|                  | YZF                             | 250-450             | 2004 > 2013 | Aluminum | <b>R-KITMOUNT103</b> | € 43,95 |
|                  | YZF                             | 250                 | 2014 > 2023 | Aluminum | <b>R-KITMOUNT104</b> | € 43,95 |
|                  | YZF                             | 450                 | 2014 > 2023 | Aluminum | <b>R-KITMOUNT104</b> | € 43,95 |
|                  | YZ-X                            | 250                 | 2016 > 2023 | Aluminum | <b>R-KITMOUNT103</b> | € 43,95 |
|                  | YZ-FX                           | 250                 | 2015 > 2023 | Aluminum | <b>R-KITMOUNT104</b> | € 43,95 |
|                  | YZ-FX                           | 450                 | 2016 > 2023 | Aluminum | <b>R-KITMOUNT104</b> | € 43,95 |
|                  | WR                              | 250                 | 2016 > 2023 | Aluminum | <b>R-KITMOUNT103</b> | € 43,95 |
|                  | WRF                             | 250                 | 2004 > 2013 | Aluminum | <b>R-KITMOUNT103</b> | € 43,95 |
|                  | WRF                             | 250                 | 2015 > 2023 | Aluminum | <b>R-KITMOUNT104</b> | € 43,95 |
|                  | WRF                             | 450                 | 2004 > 2015 | Aluminum | <b>R-KITMOUNT103</b> | € 43,95 |
|                  | WRF                             | 450                 | 2016 > 2023 | Aluminum | <b>R-KITMOUNT104</b> | € 43,95 |
| <b>KAWASAKI</b>  | KXF                             | 250                 | 2006 > 2020 | Aluminum | <b>R-KITMOUNT105</b> | € 43,95 |
|                  | KXF                             | 250                 | 2021 > 2023 | Aluminum | <b>R-KITMOUNT109</b> | € 43,95 |
|                  | KXF                             | 450                 | 2006 > 2018 | Aluminum | <b>R-KITMOUNT105</b> | € 43,95 |
|                  | KXF                             | 450                 | 2019 > 2023 | Aluminum | <b>R-KITMOUNT109</b> | € 43,95 |
|                  | KLX                             | 450                 | 2007 > 2016 | Aluminum | <b>R-KITMOUNT105</b> | € 43,95 |
|                  | KX-XC                           | 250-450             | 2021 > 2023 | Aluminum | <b>R-KITMOUNT109</b> | € 43,95 |
| <b>SUZUKI</b>    | RMZ                             | 250                 | 2007 > 2023 | Aluminum | <b>R-KITMOUNT106</b> | € 43,95 |
|                  | RMZ                             | 450                 | 2005 > 2023 | Aluminum | <b>R-KITMOUNT106</b> | € 43,95 |
|                  | RMX                             | 450                 | 2010 > 2023 | Aluminum | <b>R-KITMOUNT106</b> | € 43,95 |
| <b>KTM</b>       | SX / SXF                        | 125 > 525           | 2004 > 2014 | Aluminum | <b>R-KITMOUNT101</b> | € 43,95 |
|                  | SX / SXF                        | 125 > 450           | 2015 > 2023 | Aluminum | <b>R-KITMOUNT102</b> | € 43,95 |
|                  | EXC / EXCF                      | 125 > 530           | 2004 > 2015 | Aluminum | <b>R-KITMOUNT101</b> | € 43,95 |
|                  | EXC / EXCF                      | 125 > 500           | 2016 > 2023 | Aluminum | <b>R-KITMOUNT102</b> | € 43,95 |
| <b>HUSQVARNA</b> | TC / FC                         | 125 > 450           | 2014        | Aluminum | <b>R-KITMOUNT101</b> | € 43,95 |
|                  | TC / FC / TX / FX               | 125 > 450           | 2015 > 2023 | Aluminum | <b>R-KITMOUNT102</b> | € 43,95 |
|                  | TE / FE                         | 125 > 510           | 2014-2015   | Aluminum | <b>R-KITMOUNT101</b> | € 43,95 |
|                  | TE / FE                         | 125 > 510           | 2016 > 2023 | Aluminum | <b>R-KITMOUNT102</b> | € 43,95 |
| <b>GAS GAS</b>   | MC/MC-F/EC/ECF                  | 125-250-300-350-450 | 2021 > 2023 | Aluminum | <b>R-KITMOUNT102</b> | € 43,95 |
| <b>BETA</b>      | RR                              | 125 > 530           | 2013 > 2023 | Aluminum | <b>R-KITMOUNT107</b> | € 43,95 |
| <b>SHERCO</b>    | SE / SEF                        | 125 > 500           | 2013 > 2023 | Aluminum | <b>R-KITMOUNT108</b> | € 48,95 |
| <b>FANTIC</b>    | XX / XE                         | 125-250             | 2021 > 2023 | Aluminum | <b>R-KITMOUNT103</b> | € 43,95 |
|                  | XXF / XEF                       | 250-450             | 2021 > 2023 | Aluminum | <b>R-KITMOUNT104</b> | € 43,95 |





### PLASTIC SWINGARM PROTECTORS

- injected by a special technopolymer resistant against scratch on rocks and abstacles
- **fitting system by the original screws under the chain slider and the cable brake guide, in order to avoid the usual problem of slipping back when using only the traditional zip ties**
- Rtech graphic deco applied and protected in a special lowered seat

### PROTEZIONI FORCELLONE

- prodotte in uno speciale tecnopolimero resistente agli urti contro rocce e ostacoli
- **sistema di fissaggio tramite le viti originali sotto il pattino della catena e la guida cavo del freno, per evitare il problema di scivolamento usando solo le tradizionali fascette**



| BRAND   | MODEL               | CC                      | YEAR        | COLOR       | CODE           | PRICE         |
|---------|---------------------|-------------------------|-------------|-------------|----------------|---------------|
| HONDA   | CRF / CRF-RX        | 250                     | 2022        | Black       | R-PFCCRFRNR001 | € 49,95       |
|         | CRF/CRF-RWE/ CRF-RX | 450                     | 2021-2022   | Black       | R-PFCCRFRNR001 | € 49,95       |
| YAMAHA  | YZF                 | 250                     | 2009 > 2023 | Black       | R-PFCYZFNR001  | € 49,95       |
|         | YZ-FX               | 250                     | 2015 > 2023 | Black       | R-PFCYZFNR001  | € 49,95       |
|         | YZF                 | 450                     | 2009 > 2023 | Black       | R-PFCYZFNR001  | € 49,95       |
|         | YZ-FX               | 450                     | 2016 > 2023 | Black       | R-PFCYZFNR001  | € 49,95       |
|         | WRF                 | 250                     | 2015 > 2023 | Black       | R-PFCYZFNR001  | € 49,95       |
|         | WRF                 | 450                     | 2016 > 2023 | Black       | R-PFCYZFNR001  | € 49,95       |
| KTM     | SX                  | 125-150-250             | 2011        | Black       | R-PFCKTMNR001  | € 49,95       |
|         | SX                  | 125-150-250             | 2012 > 2022 | Black       | R-PFCKTMNR002  | € 49,95       |
|         | SX                  | 125-250-300             | 2023        | Black       | R-PFCKTMNR003  | € 49,95       |
|         | SXF                 | 250-350-450             | 2011 > 2022 | Black       | R-PFCKTMNR002  | € 49,95       |
|         | SXF                 | 250-350-450             | 2023        | Black       | R-PFCKTMNR003  | € 49,95       |
|         | SXF                 | 250-450 Factory Edition | 2022-2023   | Black       | R-PFCKTMNR003  | € 49,95       |
|         | EXC/XC-W            | 125 > 500               | 2012 > 2023 | Black       | R-PFCKTMNR001  | € 49,95       |
|         | XC / XCF            | 125 > 450               | 2023        | Black       | R-PFCKTMNR003  | € 49,95       |
|         | HUSQVARNA           | TC/FC/TE/FE             | 125 > 501   | 2014 > 2022 | Black          | R-PFCKTMNR002 |
| TC/FC   |                     | 125 > 450               | 2023        | Black       | R-PFCKTMNR003  | € 49,95       |
| TX / FX |                     | 300-350-450             | 2023        | Black       | R-PFCKTMNR003  | € 49,95       |
| FC      |                     | 250-450 Factory Edition | 2022        | Black       | R-PFCKTMNR003  | € 49,95       |
| FS      |                     | 450                     | 2023        | Black       | R-PFCKTMNR003  | € 49,95       |
| GAS GAS | MC/MC-F/EC/EC-F     | 125-250-300-350-450     | 2021-2022   | Black       | R-PFCKTMNR002  | € 49,95       |
| BETA    | RR                  | 125 > 530               | 2013 > 2019 | Black       | R-PFCBETNR001  | € 49,95       |
|         | RR                  | 125 > 480               | 2020 > 2022 | Black       | R-PFCBETNR002  | € 49,95       |
|         | XTRAINER            | 250-300                 | 2015 > 2020 | Black       | R-PFCBETNR001  | € 49,95       |
|         | XTRAINER            | 250-300                 | 2021-2022   | Black       | R-PFCBETNR002  | € 49,95       |
| FANTIC  | XXF / XEF           | 250-450                 | 2021 > 2023 | Black       | R-PFCYZFNR001  | € 49,95       |

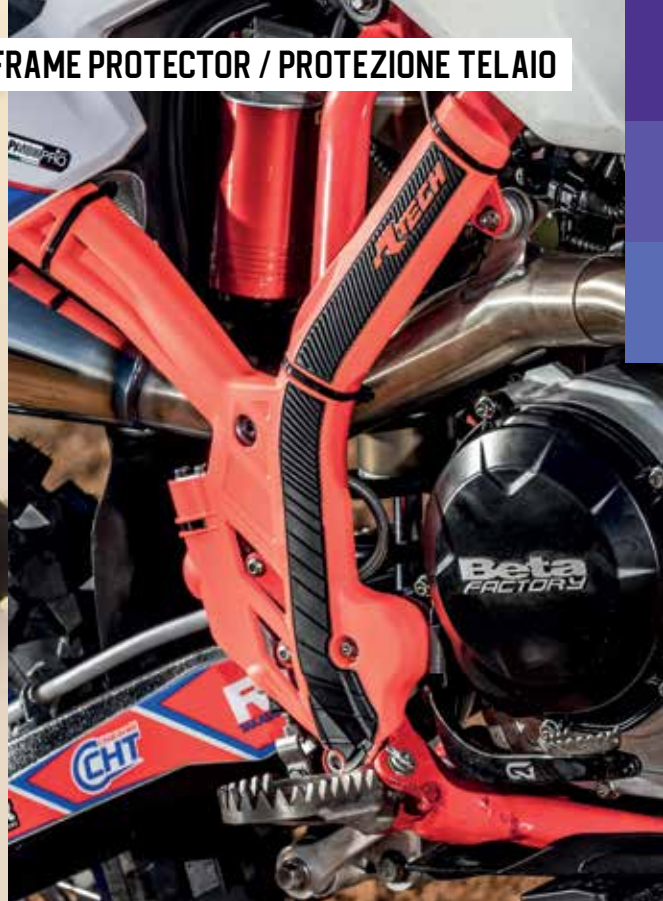

### PLASTIC/RUBBER FRAME PROTECTORS

- minimum thickness on the frame
- Rtech logo directly printed on the rubber surface
- SUITABLE FOR KTM, HUSQVARNA, BETA, GAS GAS AND FANTIC MODELS

### PROTEZIONI TELAIO

- minimo spessore sul telaio
- logo Rtech stampato direttamente sulla superficie
- ADATTE PER KTM, HUSQVARNA, BETA, GAS GAS E FANTIC

| BRAND  | MODEL                   | CC      | YEAR        | COLOR          | CODE          | PRICE   |
|--------|-------------------------|---------|-------------|----------------|---------------|---------|
| HONDA  | CRF/CRF-RX              | 250     | 2022-2023   | CR Red/Black   | R-PRTCRFRSNR1 | € 36,95 |
|        |                         |         |             | CR Red         | R-PRTCRFRS001 |         |
|        | CRF/CRF-RWE/<br>/CRF-RX | 450     | 2021 > 2023 | Black          | R-PRTCRFNR001 | € 36,95 |
|        |                         |         |             | CR Red/Black   | R-PRTCRFRSNR1 |         |
| YAMAHA | YZ                      | 85      | 2022 > 2023 | CR Red         | R-PRTCRFRS001 | € 36,95 |
|        |                         |         |             | Black          | R-PRTCRFNR001 |         |
|        | YZ                      | 125-250 | 2005 > 2023 | Black          | R-PRTYZONR003 | € 36,95 |
|        |                         |         |             | White/YZ Blue  | R-PRTYZ0BNBL3 |         |
|        | YZ                      | 125-250 | 2005 > 2023 | Black/YZ Blue  | R-PRTYZONRBL3 | € 36,95 |
|        |                         |         |             | Black          | R-PRTYZONR002 |         |
|        | YZF                     | 250     | 2019 > 2023 | White/YZ Blue  | R-PRTYZ0BNBL2 | € 36,95 |
|        |                         |         |             | Black/YZ Blue  | R-PRTYZONRBL2 |         |
|        | YZF                     | 250     | 2019 > 2023 | Black          | R-PRTYZFN001  | € 36,95 |
|        |                         |         |             | White/YZ Blue  | R-PRTYZFBNBL1 |         |
|        | YZ-FX                   | 250     | 2021 > 2023 | Black/YZ Blue  | R-PRTYZFN001  | € 36,95 |
|        |                         |         |             | Black          | R-PRTYZFN001  |         |
|        | YZF                     | 450     | 2018 > 2023 | White/YZ Blue  | R-PRTYZFBNBL1 | € 36,95 |
|        |                         |         |             | Black/YZ Blue  | R-PRTYZFN001  |         |
|        | YZ-FX                   | 450     | 2021 > 2023 | Black          | R-PRTYZFN001  | € 36,95 |
|        |                         |         |             | White/YZ Blue  | R-PRTYZFBNBL1 |         |
|        | WRF                     | 250     | 2020 > 2023 | Black/YZ Blue  | R-PRTYZFN001  | € 36,95 |
|        |                         |         |             | Black          | R-PRTYZFN001  |         |
|        | WRF                     | 450     | 2019 > 2023 | White/YZ Blue  | R-PRTYZFBNBL1 | € 36,95 |
|        |                         |         |             | Black/YZ Blue  | R-PRTYZFN001  |         |
|        | WRF                     | 450     | 2019 > 2023 | Black          | R-PRTYZFN001  | € 36,95 |
|        |                         |         |             | White/YZ Blue  | R-PRTYZFBNBL1 |         |
| KTM    | SX                      | 125-150 | 2016 > 2018 | Black/YZ Blue  | R-PRTYZFN001  | € 36,95 |
|        |                         |         |             | Black/K Orange | R-PRTKTMNRAR1 |         |
|        | SX                      | 125-150 | 2016 > 2018 | K Orange/Black | R-PRTKTMARNR1 | € 36,95 |
|        |                         |         |             | Black          | R-PRTKTMNR001 |         |
|        | SX                      | 125-150 | 2016 > 2018 | White          | R-PRTKTMBN001 | € 36,95 |
|        |                         |         |             | White/Black    | R-PRTKTMBN001 |         |

## PROTECTIONS-PROTEZIONI FRAME PROTECTOR / PROTEZIONE TELAIO

| BRAND    | MODEL                    | CC                      | YEAR   | COLOR  | CODE   | PRICE   |
|----------|--------------------------|-------------------------|--|--|--|---------|
| KTM      | SX                       | 125-150-250             | 2019 > 2022  | Black/K Orange<br>K Orange/Black<br>Black<br>White               | R-PRTKTMNRAR2<br>R-PRTKTMARNR2<br>R-PRTKTMNR002<br>R-PRTKTMBN002 | € 36,95 |
|          |                          |                         |  | White/Black  | R-PRTKTMBNNR2  |         |
|          | SX                       | 125-250-300             | 2023   | Black/K Orange<br>K Orange/Black<br>Black<br>White               | R-PRTKTMNRAR3<br>R-PRTKTMARNR3<br>R-PRTKTMNR003<br>R-PRTKTMBN003 | € 36,95 |
|          | SXF                      | 250-350-450             | 2016 > 2018  | Black/K Orange<br>K Orange/Black<br>Black<br>White               | R-PRTKTMNRAR1<br>R-PRTKTMARNR1<br>R-PRTKTMNR001<br>R-PRTKTMBN001 | € 36,95 |
|          |                          |                         |  | White/Black  | R-PRTKTMBNNR1  |         |
|          | SXF                      | 450 FACTORY EDITION     | 2018 > 2022  | Black/K Orange<br>K Orange/Black<br>Black<br>White               | R-PRTKTMNRAR2<br>R-PRTKTMARNR2<br>R-PRTKTMNR002<br>R-PRTKTMBN002 | € 36,95 |
|          |                          |                         |  | White/Black  | R-PRTKTMBNNR2  |         |
|          | SXF                      | 250-350-450             | 2019 > 2022  | Black/K Orange<br>K Orange/Black<br>Black<br>White               | R-PRTKTMNRAR2<br>R-PRTKTMARNR2<br>R-PRTKTMNR002<br>R-PRTKTMBN002 | € 36,95 |
|          |                          |                         |  | White/Black  | R-PRTKTMBNNR2  |         |
|          | SXF                      | 250-350-450             | 2023   | Black/K Orange<br>K Orange/Black<br>Black<br>White               | R-PRTKTMNRAR3<br>R-PRTKTMARNR3<br>R-PRTKTMNR003<br>R-PRTKTMBN003 | € 36,95 |
|          | SX                       | 250                     | 2017-2018  | Black/K Orange<br>K Orange/Black<br>Black<br>White               | R-PRTKTMNRAR1<br>R-PRTKTMARNR1<br>R-PRTKTMNR001<br>R-PRTKTMBN001 | € 36,95 |
|          |                          |                         |  | White/Black  | R-PRTKTMBNNR1  |         |
|          | SXF                      | 250-450 FACTORY EDITION | 2022-2023  | Black/K Orange<br>K Orange/Black<br>Black<br>White               | R-PRTKTMNRAR3<br>R-PRTKTMARNR3<br>R-PRTKTMNR003<br>R-PRTKTMBN003 | € 36,95 |
|          | XC-W                     | 125-150                 | 2017 > 2019  | Black/K Orange<br>K Orange/Black<br>Black<br>White               | R-PRTKTMNRAR1<br>R-PRTKTMARNR1<br>R-PRTKTMNR001<br>R-PRTKTMBN001 | € 36,95 |
|          |                          |                         |  | White/Black  | R-PRTKTMBNNR1  |         |
|          | EXC/EXCF/XC-W            | 250 > 500               | 2017 > 2019  | Black/K Orange<br>K Orange/Black<br>Black<br>White               | R-PRTKTMNRAR1<br>R-PRTKTMARNR1<br>R-PRTKTMNR001<br>R-PRTKTMBN001 | € 36,95 |
|          |                          |                         |  | White/Black  | R-PRTKTMBNNR1  |         |
|          | EXC/EXC-F/XC-W/<br>XCF-W | 150 > 500               | 2020 > 2023  | Black/K Orange<br>K Orange/Black<br>Black<br>White               | R-PRTKTMNRAR2<br>R-PRTKTMARNR2<br>R-PRTKTMNR002<br>R-PRTKTMBN002 | € 36,95 |
|          |                          |                         |  | White/Black  | R-PRTKTMBNNR2  |         |
|          | XC/XC-F                  | 250-300-350-450         | 2017-2018  | Black/K Orange<br>K Orange/Black<br>Black<br>White               | R-PRTKTMNRAR1<br>R-PRTKTMARNR1<br>R-PRTKTMNR001<br>R-PRTKTMBN001 | € 36,95 |
|          |                          |                         | White/Black  | R-PRTKTMBNNR1  |  |         |
| XC/XC-F  | 250-300-350-450          | 2019 > 2022             | Black/K Orange<br>K Orange/Black<br>Black<br>White | R-PRTKTMNRAR2<br>R-PRTKTMARNR2<br>R-PRTKTMNR002<br>R-PRTKTMBN002 | € 36,95  |         |
|          |                          |                         | White/Black  | R-PRTKTMBNNR2  |  |         |
| XC / XCF | 125 > 450                | 2023                    | Black/K Orange<br>K Orange/Black<br>Black<br>White | R-PRTKTMNRAR3<br>R-PRTKTMARNR3<br>R-PRTKTMNR003<br>R-PRTKTMBN003 | € 36,95  |         |

# PROTECTIONS-PROTEZIONI FRAME PROTECTOR / PROTEZIONE TELAIO



| BRAND      | MODEL                | CC                      | YEAR                  | COLOR                 | CODE           | PRICE   |
|------------|----------------------|-------------------------|-----------------------|-----------------------|----------------|---------|
| HUSQVARNA  | TC                   | 125                     | 2016 > 2022           | White/Black           | R-PRTKTMBNNR1  | € 36,95 |
|            |                      |                         |                       | White/Blue            | R-PRTKTMBNBL1  |         |
|            |                      |                         |                       | Black                 | R-PRTKTMMNR001 |         |
|            |                      |                         |                       | White                 | R-PRTKTMBN001  |         |
|            | TC                   | 250                     | 2017 > 2022           | Anthracite grey/Black | R-PRTKTMGANR1  | € 36,95 |
|            |                      |                         |                       | White/Black           | R-PRTKTMBNNR1  |         |
|            |                      |                         |                       | White/Blue            | R-PRTKTMBNBL1  |         |
|            |                      |                         |                       | Black                 | R-PRTKTMMNR001 |         |
|            | TC / FC              | 125 > 450               | 2023                  | White                 | R-PRTKTMBN001  | € 36,95 |
|            |                      |                         |                       | Black                 | R-PRTKTMBN001  |         |
|            |                      |                         |                       | Anthracite grey/Black | R-PRTKTMGANR1  |         |
|            | FC                   | 250-450 FACTORY EDITION | 2022                  | White/Black           | R-PRTHSQBNNR3  | € 36,95 |
|            |                      |                         |                       | White/Blue            | R-PRTHSQBLBN3  |         |
|            |                      |                         |                       | Black                 | R-PRTHSQNR003  |         |
|            | TE-FE                | 125 > 501               | 2017 > 2023           | White/Black           | R-PRTHSQBNNR3  | € 36,95 |
|            |                      |                         |                       | White/Blue            | R-PRTHSQBLBN3  |         |
|            |                      |                         |                       | Black                 | R-PRTHSQNR003  |         |
|            |                      |                         |                       | White                 | R-PRTKTMBN001  |         |
|            | TX-FX                | 125 > 501               | 2017 > 2022           | Anthracite grey/Black | R-PRTKTMGANR1  | € 36,95 |
|            |                      |                         |                       | White/Black           | R-PRTKTMBNNR1  |         |
| White/Blue |                      |                         |                       | R-PRTKTMBNBL1         |                |         |
| Black      |                      |                         |                       | R-PRTKTMMNR001        |                |         |
| TX / FX    | 300-350-450          | 2023                    | White                 | R-PRTKTMBN001         | € 36,95        |         |
|            |                      |                         | Black                 | R-PRTKTMBN001         |                |         |
|            |                      |                         | Anthracite grey/Black | R-PRTKTMGANR1         |                |         |
|            |                      |                         | White/Black           | R-PRTHSQBNNR3         |                |         |
| FS         | 450                  | 2023                    | White/Blue            | R-PRTHSQBLBN3         | € 36,95        |         |
|            |                      |                         | Black                 | R-PRTHSQNR003         |                |         |
|            |                      |                         | White/Black           | R-PRTHSQBNNR3         |                |         |
| FC         | 250-350-450          | 2016 > 2022             | White/Black           | R-PRTKTMBNNR1         | € 36,95        |         |
|            |                      |                         | White/Blue            | R-PRTKTMBNBL1         |                |         |
|            |                      |                         | Black                 | R-PRTKTMMNR001        |                |         |
|            |                      |                         | White                 | R-PRTKTMBN001         |                |         |
| FC         | 450 ROCKSTAR EDITION | 2018 > 2022             | Anthracite grey/Black | R-PRTKTMGANR1         | € 36,95        |         |
|            |                      |                         | White/Black           | R-PRTKTMBNNR1         |                |         |
|            |                      |                         | White/Blue            | R-PRTKTMBNBL1         |                |         |
|            |                      |                         | Black                 | R-PRTKTMMNR001        |                |         |
| FS         | 450                  | 2017 > 2022             | White                 | R-PRTKTMBN001         | € 36,95        |         |
|            |                      |                         | Black                 | R-PRTKTMBN001         |                |         |
|            |                      |                         | Anthracite grey/Black | R-PRTKTMGANR1         |                |         |
|            |                      |                         | White/Black           | R-PRTKTMBNNR1         |                |         |
| GAS GAS    | MC/MC-F/EC/EC-F      | 125-250-300-350-450     | 2021 > 2023           | G Red/Black           | R-PRTKTMRGNR1  | € 36,95 |
|            |                      |                         |                       | Black                 | R-PRTKTMMNR001 |         |
|            |                      |                         |                       | White                 | R-PRTKTMBN001  |         |
|            |                      |                         |                       | White/Black           | R-PRTKTMBNNR1  |         |
| BETA       | RR                   | 125 > 480               | 2020 > 2023           | Black                 | R-PRTBETNR001  | € 36,95 |
|            |                      |                         |                       | Red/Black             | R-PRTBETRSNR1  |         |
|            |                      |                         |                       | Red                   | R-PRTBETRS001  |         |
| FANTIC     | XXF / XEF            | 250                     | 2021 > 2023           | Black                 | R-PRTYZFN001   | € 36,95 |
|            |                      |                         |                       | Red/Black             | R-PRTYZFRSNR1  |         |
|            | XXF                  | 450                     | 2021 > 2022           | Black                 | R-PRTYZFN001   | € 36,95 |
|            |                      |                         |                       | Red/Black             | R-PRTYZFRSNR1  |         |
|            | XXF                  | 450                     | 2023                  | Black                 | R-PRTYZFN004   | € 36,95 |
|            |                      |                         |                       | Red/Black             | R-PRTYZFRSNR4  |         |
| XEF        | 450                  | 2021 > 2023             | Black                 | R-PRTYZFN001          | € 36,95        |         |
|            |                      |                         | Red/Black             | R-PRTYZFRSNR1         |                |         |
| XX / XE    | 125-250-300          | 2021 > 2023             | Black                 | R-PRTYZONR002         | € 36,95        |         |
|            |                      |                         | Red/Black             | R-PRTYZORSNR2         |                |         |



### MONOBLOCK R2.0 WORX CHAIN GUIDE

- Complete new concept of Monoblock chain guide
- Exceptional strength and endurance thanks to the internal removable TPU wear pad with self-lubricating capabilities
- Extra resistant special formula technopolymer frame construction
- Great stability and impact absorbion with elastic impact memory
- CNC bushings included - Plug and play, doesn't require modification to the original bracket
- Rtech permanent graphic deco applied
- Packaging dimensions: 250x150x50 mm - Gross weight 260g



### CRUNA GUIDACATENA MONOBLOCK R2.0 WORX

- Concetto completamente innovativo di cruna guida catena Monoblock
- Eccezionale durata grazie al pattino antiusura interno in TPU autolubrificante facilmente rimovibile
- Costruzione in tecnopolimero di esclusiva formulazione extra resistente
- Grande stabilità ed assorbimento degli impatti con memoria elastica all'urto
- Boccole fresate a CNC incluse - Pronta all'uso, non richiede modifiche al supporto originale
- Applicazione grafica permanente
- Dimensioni imballo: 250x150x50 mm - Peso lordo: 260g

| BRAND    | MODEL                     | CC          | YEAR        | COLOR           | CODE            | PRICE   |
|----------|---------------------------|-------------|-------------|-----------------|-----------------|---------|
| HONDA    | CRF/CRF-RX/CRFX<br>CRF-L  | 250 > 450   | 2007 > 2023 | CR Red/Black    | R-CRUCRFRSNR20  | € 52,95 |
|          |                           |             |             | Black           | R-CRUCRFNR0020  |         |
|          |                           |             |             | White/Black     | R-CRUCRFBNNR20  |         |
| YAMAHA   | YZ/YZF/WRF/YZ-X/<br>YZ-FX | 125 > 450   | 2007 > 2023 | YZ Blue/Black   | R-CRUYZFBLLNR20 | € 52,95 |
|          |                           |             |             | Black           | R-CRUYZFNRR0020 |         |
|          |                           |             |             | White/Black     | R-CRUYZFBNNR20  |         |
| KAWASAKI | KXF                       | 250-450     | 2009 > 2023 | KX Green/Black  | R-CRUKXFVNR20   | € 52,95 |
|          |                           |             |             | Black           | R-CRUKXFNR0020  |         |
|          |                           |             |             | White/Black     | R-CRUKXFBNNR20  |         |
|          | KLX-R                     | 450         | 2012 > 2016 | KX Green/Black  | R-CRUKXFVNR20   | € 52,95 |
|          |                           |             |             | Black           | R-CRUKXFNR0020  |         |
| SUZUKI   | RM                        | 125-250     | 1999 > 2011 | RM Yellow/Black | R-CRURMZGINR20  | € 52,95 |
|          |                           |             |             | Black           | R-CRURMZNR0020  |         |
|          | RMZ                       | 250         | 2007 > 2018 | White/Black     | R-CRURMZBNNR20  | € 52,95 |
|          |                           |             |             | RM Yellow/Black | R-CRURMZGINR20  |         |
|          | RMZ                       | 250         | 2019 > 2023 | Black           | R-CRURMZNR0020  | € 52,95 |
|          |                           |             |             | White/Black     | R-CRURMZBNNR20  |         |
|          | RMZ                       | 450         | 2005 > 2017 | RM Yellow/Black | R-CRURMZGINR20  | € 52,95 |
|          |                           |             |             | Black           | R-CRURMZNR0020  |         |
|          | RMZ                       | 450         | 2018 > 2023 | White/Black     | R-CRURMZBNNR20  | € 52,95 |
|          |                           |             |             | RM Yellow/Black | R-CRURMZGINR20  |         |
|          | RMZ                       | 450         | 2010 > 2019 | Black           | R-CRURMZNR0020  | € 52,95 |
|          |                           |             |             | White/Black     | R-CRURMZBNNR20  |         |
| RMZ      | 450                       | 2010 > 2019 | Black       | R-CRURMZNR0020  | € 52,95         |         |
|          |                           |             | White/Black | R-CRURMZBNNR20  |                 |         |

| BRAND     | MODEL                    | CC             | YEAR        | COLOR          | CODE           | PRICE   |
|-----------|--------------------------|----------------|-------------|----------------|----------------|---------|
| KTM       | SX/SXF/XC-F              | 125 > 450      | 2007 > 2023 | Black/K Orange | R-CRUKTMNRR20  | € 52,95 |
|           |                          |                |             | K Orange/Black | R-CRUKTMARNR20 |         |
|           |                          |                |             | White/Black    | R-CRUKTMBNNR20 |         |
|           |                          |                |             | Black          | R-CRUKTMNR0020 |         |
|           | EXC/EXC-F/XC-W           | 125 > 500      | 2008 > 2023 | Black/K Orange | R-CRUKTMNRR20  | € 52,95 |
|           |                          |                |             | K Orange/Black | R-CRUKTMARNR20 |         |
|           |                          |                |             | White/Black    | R-CRUKTMBNNR20 |         |
|           |                          |                |             | Black          | R-CRUKTMNR0020 |         |
| HUSQVARNA | TC/FC/TE/TX/<br>FX/FE/FS | 85 > 501       | 2014 > 2023 | White/Black    | R-CRUKTMBNNR20 | € 52,95 |
| GAS GAS   | EC/EC-F                  | 250-300-350    | 2018 > 2023 | HSQ Blue/Black | R-CRUKTMBLNR20 | € 52,95 |
|           |                          |                |             | G Red/Black    | R-CRUKTMRSNR20 |         |
|           | MC/MC-F                  | 85-125-250-450 | 2021 > 2023 | White/Black    | R-CRUKTMBNNR20 | € 52,95 |
|           |                          |                |             | Black          | R-CRUKTMNR0020 |         |
| BETA      | RR / RX                  | 125 > 530      | 2013 > 2023 | G Red/Black    | R-CRUKTMRSNR20 | € 52,95 |
|           |                          |                |             | White/Black    | R-CRUKTMBNNR20 |         |
|           | XTRAINER                 | 250-300        | 2015 > 2023 | Black          | R-CRUBETNR0020 | € 52,95 |
|           |                          |                |             | Red/Black      | R-CRUBETRSNR20 |         |
| SHERCO    | SE-SEF                   | 125 > 500      | 2013 > 2023 | White/Black    | R-CRUKTMBNNR20 | € 52,95 |
|           |                          |                |             | Black          | R-CRUKTMNR0020 |         |
| FANTIC    | XX / XE / /XXF / XEF     | 125-250-450    | 2021 > 2023 | Black          | R-CRUKTMBLNR20 | € 52,95 |
|           |                          |                |             | White/Black    | R-CRUYZFBNNR20 |         |
| TM        | MX / EM / SM             | 85 > 530       | 2007 > 2023 | Black          | R-CRUTM0BLNR21 | € 52,95 |
|           |                          |                |             |                | R-CRUTMONR0021 |         |



**MONOBLOCK R2.0 WORX CHAIN GUIDE SPARE PARTS**  
**RICAMBI CRUNA GUIDACATENA MONOBLOCK R2.0 WORX CHAIN**



€ 13.95



Monoblock R2.0 Worx Chain internal wear pad - Black  
 Inserto di ricambio cruna Monoblock R2.0 Worx Chain - Nero  
**R-PATTNR00020**

Monoblock R2.0 Worx Chain internal wear pad - Orange  
 Inserto di ricambio cruna Monoblock R2.0 Worx Chain - Arancione  
**R-PATTAR00020**



**Husqvarna**  
MOTORCYCLES

ZANARDOV



JET

REKLISE

ESK

ESK

## **TRACK WORKSHOP**

- R15 Worx Bike Stand >pag 258*
- Bike Stand >pag 260*
- Tire Mousse Levers >pag 262*
- Evolution Tire Changer and Stand >pag 263*
- Rim Lock >pag 264*
- Air Valve Puller >pag 264*
- Spring Pulling Tool >pag 264*
- Diaphragm Type Gauge >pag 264*
- Wire Pliers >pag 264*
- MX Boot Wash Steel Stand >pag 264*
- Nashua Tape >Pag 264*
- Nylon Zip Ties >pag 265*
- Mud Remover >Pag 265*
- Reticulated Foam >Pag 265*
- Chain Brush >Pag 265*
- Rtech R15 Gas Can >pag 266*
- Liquid Measuring Beakers >Pag 268*
- Ecotanks >pag 269*
- Paddock Floor Mat >pag 269*
- Wireless Erasable Hour Meter >pag 270*
- Starting Blocks >pag 271*
- Extreme Enduro Front Strap >pag 272*
- Aluminum Folding Ramp >pag 272*
- Tie Downs >pag 273*
- Track Marker / Stake Hammer / Track Tape >pag 274*
- Pit Board >Pag 275*
- PVC Number Sticker >Pag 275*



€ 94.95

## R15 WORX BIKE STAND

Anti shock molded construction, technopolymer sturdy bars with embossed Rtech logo for exceptional strength and endurance

Extra wide stance provides exceptional stability

Non-Slip pyramid frame plate surface allows fluids to drain easily

Large graphic side panels can be customized for a 100% factory look

Includes a unique frame plate wedge to assure a stable it for all frame types

### Stackable for easy storage of multiple units

Height 17 inch (43 cm) - Total weight 7.3 lbs. (3.3 kg) - Maximum load capacity 510 lbs. (230 kg)

*Realizzato in materiale antiurto, robuste traverse in tecnopolimero con logo Rtech in rilievo, tappeto superiore in gomma antiscivolo e viteria in acciaio zincato.*

*Caratterizzato da un design di ultimissima generazione.*

*Leggero, resistente, e grazie ai larghi piedini di appoggio molto stabile.*

*Pannelli laterali su cui applicare grafiche personalizzate, per un look 100% factory!!*

### Impilabile

*Altezza 43 cm - Peso totale 3.3 kg - Portata massima 230 Kg*



Designed to hold R15 tanks, optimizing space during transport.

*Progettato per contenere la tanica R15, ottimizzando lo spazio durante il trasporto.*



## SPARE PARTS

### RICAMBI

| DESCRIPTION                                | CODE          | PRICE   |
|--|---------------|---------|
| Non-slip black top rubber replacement part | R-REPTAVCV1NR | € 19,95 |
| Replacement stickers set red/white         | R-REPADES15BN | € 6,95  |
| Replacement stickers set red/black         | R-REPADES15NR | € 6,95  |

Non-Slip pyramid frame plate surface allows fluids to drain easily.  
Includes a unique frame plate wedge to assure a stable it for all frame types.

*Tappeto superiore con piramidi antiscivolo per facilitare il drenaggio dei liquidi.  
Rialzo removibile per stabilizzare la moto.*

**COLORI DISPONIBILI / AVAILABLE COLORS**



Quantum Grey  
R-CAVMX0015GR



White  
R-CAVMX0015BN



Red  
R-CAVMX0015RS



Orange  
R-CAVMX0015AR



Black  
R-CAVMX0015NR



Green  
R-CAVMX0015VE



Blue  
R-CAVMX0015BL



Neon Green  
R-CAVMX0015VF



Neon Orange  
R-CAVMX0015AN



Neon Yellow  
R-CAVMX0015GF



Yellow  
R-CAVMX0015GI

> OPTIONAL: R15 WORX OIL TANK



€ 27.95

R15 WORX OIL TANK  
capacity 2.56 gal (5 lt.) / *Tanica 5 lt. raccolta olio*  
R-R15TANKNR01





### FOOT LIFT STAND

Large diameter high strength tubular steel is robotically welded and then two stage powder coated for durability for years to come. These 100% made in Italy stands incorporate a Rubber/Plastic base surface with radial grooves to guarantee great grip. Easy to lift, these stands incorporate a high quality return spring and color-coordinated feet. Available in two heights for Minis/Supermoto @ 10.25" minimum height, and 11.75" minimum height for Motocross/Oftoad bikes. Maximum weight is 440lbs. /200kg.



### CAVALLETTO A LEVA

Con struttura metallica saldata a robot in acciaio ad alto resistenziale, verniciata a forno a polveri epossidiche con primo strato nero e secondo trasparente opaco a base acrilica per esterno.

Disponibile in versione cross/enduro oppure motard/minicross.

Ripiano in speciale materiale plastico semimorbido antiscivolo con gole radiali per scarico del fango.

Molla di richiamo, pinza blocco di sicurezza per leva con tappo in tinta e piedini colorati in materiale plastico antiscivolo ed antigraffio.

Portata 200 kg.

#### OEM original color

| DESCRIPTION               | COLOR                             | CODE              | PRICE         |         |
|---------------------------|-----------------------------------|-------------------|---------------|---------|
| Motocross Foot Lift Stand | Black-Orange                      | R-CVACCARC00      | € 99,95       |         |
|                           | Black-Blue                        | R-CVACCBLCR00     | € 99,95       |         |
|                           | Black-Yellow                      | R-CVACCGICR00     | € 99,95       |         |
|                           | Black-Neon Yellow                 | R-CVACCGFCR00     | € 99,95       |         |
|                           | Black-Neon Orange                 | R-CVACCANC00      | € 99,95       |         |
|                           | Black-Black                       | R-CVACCNRC00      | € 99,95       |         |
|                           | Black-Red                         | R-CVACCRSCR00     | € 99,95       |         |
|                           | Black-Green                       | R-CVACCVEC00      | € 99,95       |         |
|                           | Mini MX/Supermoto Foot Lift Stand | Black-Yellow      | R-CVACCGISM00 | € 99,95 |
|                           |                                   | Black-Neon Yellow | R-CVACCGFSM00 | € 99,95 |
| Black-Neon Orange         |                                   | R-CVACCANSM00     | € 99,95       |         |
| Black-Red                 |                                   | R-CVACCRSSM00     | € 99,95       |         |
| Black-Green               |                                   | R-CVACCVESM00     | € 99,95       |         |
| Black-Blue                |                                   | R-CVACCBLSM00     | € 99,95       |         |
| Black-Black               |                                   | R-CVACCNRSM00     | € 99,95       |         |
| Black-Orange              |                                   | R-CVACCARS00      | € 99,95       |         |

Motocross foot lift stand  
Cavalletto a leva Cross/Enduro  
**R-CVACCRSCROO**



Mini/Motard foot lift stand  
Cavalletto a leva Mini/Motard  
**R-CVACCVESM00**



Safety clamp lock detail  
Dettaglio pinza blocca leva di sicurezza



WORKSHOP-BOX OFFICINA BIKE STAND REPLACEMENT TOP PLATES  
TAVOLETTA DI RICAMBIO PER CAVALLETTO



**R-REPTAVCVOGI**



**R-REPTAVCVONR**



**R-REPTAVCV0BL**



**R-REPTAVCVORS**



**R-REPTAVCV0VE**



**R-REPTAVCV0AR**



**R-REPTAVCV0GF**



**R-REPTAVCV0AN**

| DESCRIPTION | CODE                 | PRICE   |
|-------------|----------------------|---------|
| Orange      | <b>R-REPTAVCV0AR</b> | € 19,95 |
| Blue        | <b>R-REPTAVCV0BL</b> | € 19,95 |
| Yellow      | <b>R-REPTAVCVOGI</b> | € 19,95 |
| Neon Yellow | <b>R-REPTAVCV0GF</b> | € 19,95 |
| Neon Orange | <b>R-REPTAVCV0AN</b> | € 19,95 |
| Black       | <b>R-REPTAVCVONR</b> | € 19,95 |
| Red         | <b>R-REPTAVCVORS</b> | € 19,95 |
| Green       | <b>R-REPTAVCV0VE</b> | € 19,95 |



**GRAND PRIX  
ALUMINUM BIKE STAND**

Strong aluminum Grand Prix bike stand made by aluminum light alloy entirely welded hand-made with TIG technology, complete of with beech-wood board and crystall graphic applied.



R-CVALUGRGP00

€ 119.95

**CAVALLETTO IN ALLUMINIO  
GRAND PRIX**

Realizzato con struttura in lega leggera di alluminio saldata interamente a mano con tecnologia a TIG. Con piano d'appoggio in legno multistrato e grafica adesiva in crystall applicata.

WORKSHOP-BOX OFFICINA TIRE MOUSSE LEVERS / LEVE SMONTAGOMME



| DESCRIPTION                                    | COLOR      | CODE          | PRICE   |
|--|------------|---------------|---------|
| Tire /mousse lever L 430mm with handle         | Galvanized | R-LEVAMOUSSE1 | € 34,95 |
| Tire /mousse straight lever L 380mm            | Galvanized | R-LEVAGOMME01 | € 26,95 |
| Tire /mousse curve lever L 380mm               | Galvanized | R-LEVAGOMME02 | € 27,95 |
| Tire /mousse lever L 340 mm with non slip grip | Galvanized | R-LEVAGOMME03 | € 26,95 |

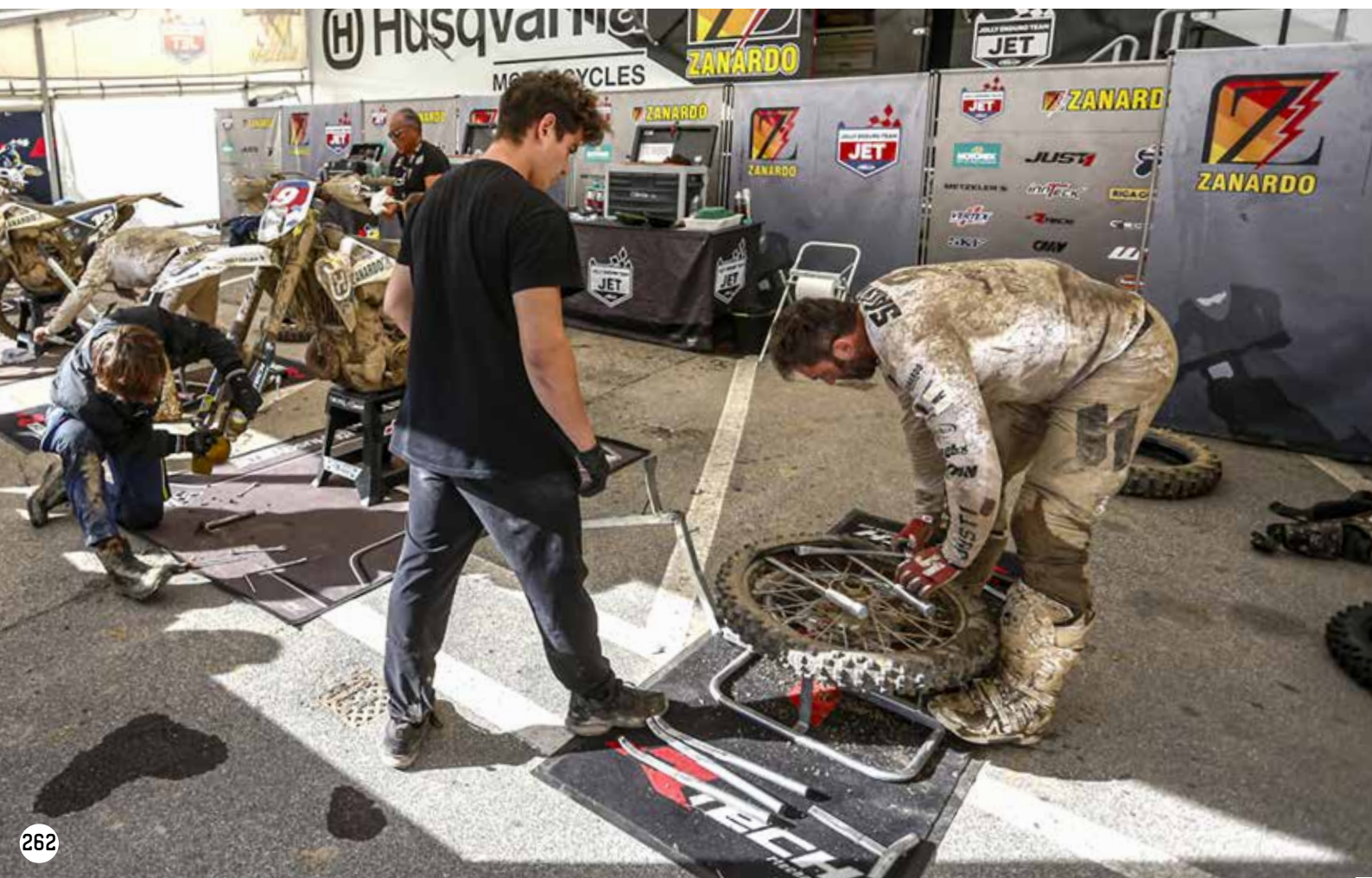

## EVOLUTION TIRE CHANGER

Designed and manufactured 100% in Italy, the RTech tire changer utilizes the most advanced materials and race experience gained from working with the top factory teams in the Enduro World Championship. RTech's extensive race experience guarantees the easiest, safest and most intuitive product on the market. The ergonomic grip assures an easy, safe hold of the lever while allows the easy removal of the tire from the rim at the same time. Great for home, shop or race track use!

## SMONTAGOMME EVOLUTION

La struttura metallica tagliata a laser e saldata a robot, interamente zincata, è realizzata in tubolare e lama d'acciaio di qualità superiore ad alto resistenziale e garantisce una durata assicurata negli anni. Adatto per ruote da 17 a 21 pollici di diametro. Usato dai più importanti team ufficiali del mondiale enduro.



### R-SMONTAG0018

Stand not included / Rialzo non incluso

€ 229.95

New traverse for lever locking

Nuova staffa bloccaggio leva

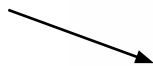

New 90° welded lever without articulated join, greater rigidity and ease of use.

Nuova leva a 90° senza snodo, maggiore rigidità e facilità di utilizzo. Movimento telescopico per una regolazione millimetrica in base al diametro della ruota.



The "third hand"

It allows to the lever to keep the right position at 180° helping the inserting of the tire.

Facilita l'inserimento del copertone tenendo il levagomme in posizione di sicurezza a 180°. Il copertone così stallonato sarà molto più agevole da montare.

## TIRE CHANGER STAND

Designed and manufactured 100% in Italy, the RTech Tire Stand makes tire changing even easier by raising the height of the RTech tire changer for stand-up use. This tire changer stand features special semi-soft plastic feet to ensure stability, while it avoids marking the floor and reducing noise when moved. Its high quality laser cut structure, robotically welded is fully galvanized and constructed from tubular steel to give it super durability. It is suitable for all motorcycle wheels from 17 to 21 inches in diameter.

## RIALZO PER SMONTAGOMME

Il rialzo smonta gomme in acciaio è il complemento ideale per un'attrezzatura che permette di lavorare ad un'altezza da terra ottimale con la massima stabilità e sicurezza evitando posizioni a rischio di infortunio.

€ 112.95



R-RIALSMONT14

## WORKSHOP-BOX OFFICINA RIM LOCK / FERMA COPERTONE



R-FERMACOP215



R-FERMACOP160



R-FERMACOP185



R-FERMACOP250

| COLOR | CODE          | DESCRIPTION         | PRICE   |
|-------|---------------|---------------------|---------|
| Black | R-FERMACOP160 | Rim lock 1.40/1.60' | € 23,95 |
| Black | R-FERMACOP185 | Rim lock 1.85'      | € 23,95 |
| Black | R-FERMACOP215 | Rim lock 2.15'      | € 23,95 |
| Black | R-FERMACOP250 | Rim lock 2.50'      | € 23,95 |

### WORKSHOP-BOX OFFICINA AIR VALVE PULLER / TIRAVALVOLA



R-TIRAVALVRS1

€ 17.95

### WORKSHOP-BOX OFFICINA SPRING PULLING TOOL TIRA MOLLA



€ 17.95

R-TIRAMOLLA

### WORKSHOP-BOX OFFICINA DIAPHRAM TYPE CAUGE / MANOMETRO



MANOMETRO01

€ 32.95

### WORKSHOP-BOX OFFICINA NASHUA TAPE / NASTRO AMERICANO

50 mm x 20 mt



black / nero  
R-TAPE000NR20

€ 11.95



grey / grigio  
R-TAPE000SI20

€ 11.95

### WORKSHOP-BOX OFFICINA MX BOOT WASH STEEL STAND SUPPORTO LAVAGGIO / ASCIUGATURA STIVALI

Made of galvanized steel, it is equipped with non-slip feet. It allows quick wash and their optimal drying preventing of bacteria and unpleasant smells. Weight 1.7kg.

Realizzato in acciaio zincato, è dotato di piedini antiscivolo, permette un rapido lavaggio degli stivali ed una loro ottimale asciugatura scongiurando la formazione di batteri e cattivi odori. Peso 1,7 kg.



€ 44.95

R-LAVASTIV015



### WORKSHOP-BOX OFFICINA WIRE PLIERS / PINZA GIRAFILO

R-PINZAFILO01

€ 49.95



## WORKSHOP-BOX OFFICINA NYLON ZIP TIES / FASCETTE IN NYLON

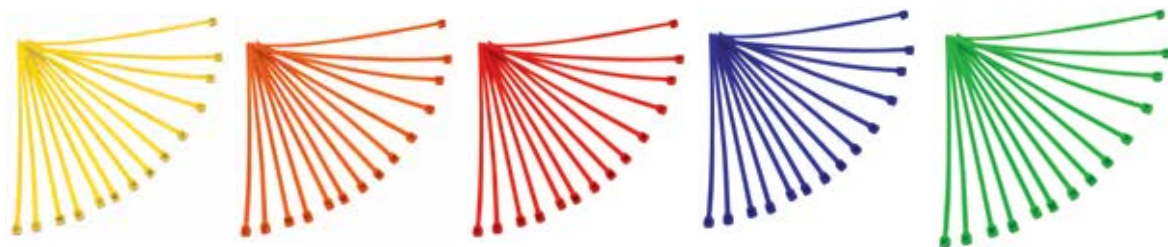

R-FASC36180GI

R-FASC36180AR

R-FASC36180RS

R-FASC36180BL

R-FASC36180VE

Super strong and colorful nylon zip ties for every purpose.

Realizzate in nylon 6.6 di alta qualità consentono una resistenza superiore assicurando un look di sicuro effetto.

| DESCRIPTION                | COLOR  | CODE          | PRICE  |
|----------------------------|--------|---------------|--------|
| Zip ties 3,6x180mm (100pz) | Orange | R-FASC36180AR | € 7,95 |
|                            | Blue   | R-FASC36180BL | € 7,95 |
|                            | Yellow | R-FASC36180GI | € 7,95 |
|                            | Black  | R-FASC36180NR | € 7,95 |
|                            | Red    | R-FASC36180RS | € 7,95 |
|                            | Green  | R-FASC36180VE | € 7,95 |
| Zip ties 4,8x280mm (100pz) | Orange | R-FASC48280AR | € 8,95 |
|                            | Blue   | R-FASC48280BL | € 8,95 |
|                            | Yellow | R-FASC48280GI | € 8,95 |
|                            | Black  | R-FASC48280NR | € 8,95 |
|                            | Red    | R-FASC48280RS | € 8,95 |
|                            | Green  | R-FASC48280VE | € 8,95 |

## WORKSHOP-BOX OFFICINA MUD REMOVER SPATOLA TOGLIFANGO



| COLOR  | CODE          | PRICE  |
|--------|---------------|--------|
| Orange | R-MUDRMAR0300 | € 9,95 |
| Blue   | R-MUDRMBLY300 | € 9,95 |
| Yellow | R-MUDRMGI0300 | € 9,95 |
| Black  | R-MUDRMNR0300 | € 9,95 |
| Red    | R-MUDRMRS0300 | € 9,95 |
| Green  | R-MUDRMVE0300 | € 9,95 |



## WORKSHOP-BOX OFFICINA CHAIN BRUSH SPAZZOLA PULISCICATENA



R-CHBRUSHBL11

€ 20.95

## WORKSHOP-BOX OFFICINA

€ 16.95



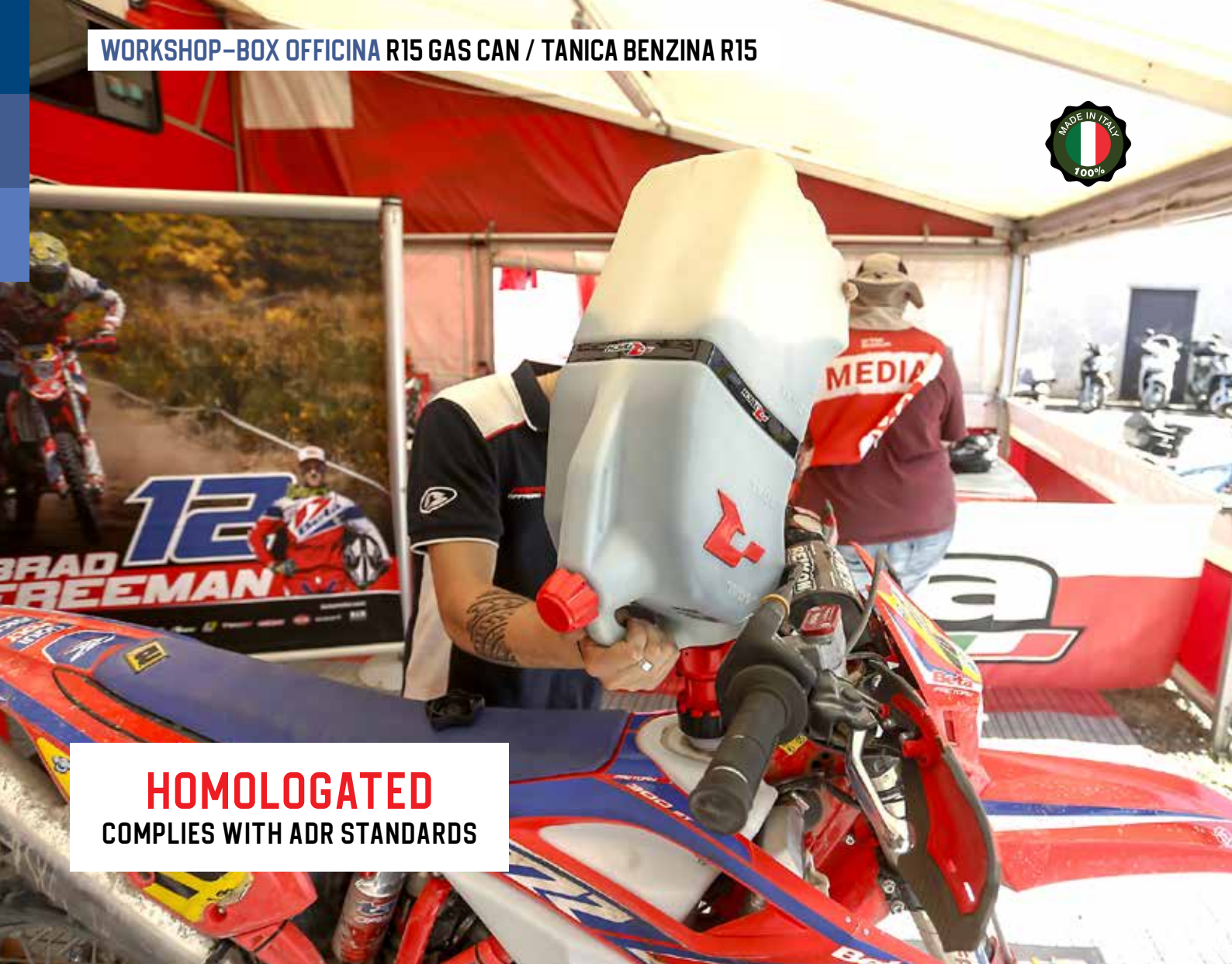

**HOMOLOGATED**  
COMPLIES WITH ADR STANDARDS

### RTECH R15 GAS CAN

Capacity 15 LT (4.0 Gallon) made by hi-quality HDPE plastic.

Comes complete with transportation cap.

3" extra wide fill cap or easy and quick filling.

Strategically placed handle on the top for transportation and the side, perfectly balanced, for refueling.

Rtech gas can includes an indent that allows the use of Rtech tie-downs to strap into place during transport.



### TANICA RTECH 15 LITRI

- Realizzata in HDPE.

- Tubo di rifornimento con chiusura di sicurezza rapida.

- Robusta maniglia laterale che garantisce un comodo bilanciamento durante il rifornimento.

- Maniglia superiore ergonomica per il trasporto.

- Tappo di carico con sfiato per velocizzare il rifornimento, posizionato in modo da evitare sversamenti.



| CODICE        | DESCRIZIONE            | PRICE   |
|---------------|------------------------|---------|
| R-GASCAAR0017 | Rtech Gas Can - Orange | € 74,95 |
| R-GASCABLO017 | Rtech Gas Can - Blue   | € 74,95 |
| R-GASCAGI0017 | Rtech Gas Can - Yellow | € 74,95 |
| R-GASCARS0017 | Rtech Gas Can - Red    | € 74,95 |
| R-GASCAVE0017 | Rtech Gas Can - Green  | € 74,95 |
| R-GASCANR0017 | Rtech Gas Can - Black  | € 74,95 |

€ 74.95

RTECH R15 RGAS CAN QUICK FILL



| CODICE        | DESCRIZIONE                                   | PRICE   |
|---------------|---|---------|
| R-GASCAAR0020 | Rtech Gas Can with quick fill system - Orange | € 74,95 |
| R-GASCABL0020 | Rtech Gas Can with quick fill system - Blue   | € 74,95 |
| R-GASCAGI0020 | Rtech Gas Can with quick fill system - Yellow | € 74,95 |
| R-GASCARS0020 | Rtech Gas Can with quick fill system - Red    | € 74,95 |
| R-GASCAVE0020 | Rtech Gas Can with quick fill system - Green  | € 74,95 |
| R-GASCANR0020 | Rtech Gas Can with quick fill system - Black  | € 74,95 |



## GAS CAN FUEL HOSE KIT KIT RICAMBIO TUBO TANICA

| CODE          | DESCRIPTION                             | PRICE   |
|---------------|---|---------|
| R-GASCANTBVEO | Gas can complete fuel tube kit - Green  | € 20,95 |
| R-GASCANTBARO | Gas can complete fuel tube kit - Orange | € 20,95 |
| R-GASCANTBBLO | Gas can complete fuel tube kit - Blue   | € 20,95 |
| R-GASCANTBGIO | Gas can complete fuel tube kit - Yellow | € 20,95 |
| R-GASCANTBRSO | Gas can complete fuel tube kit - Red    | € 20,95 |
| R-GASCANTBNRO | Gas can complete fuel tube kit - Black  | € 20,95 |



## GAS CAN REPLACEMENT KIT KIT RICAMBIO ACCESSORI TANICA

| CODE          | DESCRIPTION   | PRICE   |
|---------------|---|---------|
| R-GASCANACARO | Gas can accessories kit: caps, handle, logo, sticker - Orange | € 19,95 |
| R-GASCANACBLO | Gas can accessories kit: caps, handle, logo, sticker - Blue   | € 19,95 |
| R-GASCANACGIO | Gas can accessories kit: caps, handle, logo, sticker - Yellow | € 19,95 |
| R-GASCANACRSO | Gas can accessories kit: caps, handle, logo, sticker - Red    | € 19,95 |
| R-GASCANACVEO | Gas can accessories kit: caps, handle, logo, sticker - Green  | € 19,95 |
| R-GASCANACNRO | Gas can accessories kit: caps, handle, logo, sticker - Black  | € 19,95 |



## GAS CAN COMPLETE QUICK FILL CONVERSION KIT KIT CONVERSIONE RIFORNIMENTO RAPIDO

| CODE          | DESCRIPTION   | PRICE   |
|---------------|---|---------|
| R-GASCANQFRSO | Gas can complete quick fill conversion kit - Red    | € 24,95 |
| R-GASCANQFBLO | Gas can complete quick fill conversion kit - Blue   | € 24,95 |
| R-GASCANQFGIO | Gas can complete quick fill conversion kit - Yellow | € 24,95 |
| R-GASCANQFVEO | Gas can complete quick fill conversion kit - Green  | € 24,95 |
| R-GASCANQFARO | Gas can complete quick fill conversion kit - Orange | € 24,95 |
| R-GASCANQFNRO | Gas can complete quick fill conversion kit - Black  | € 24,95 |



Gas Can complete seals kit  
Kit guarnizioni ricambio tanica  
**R-GASCANSEALS**

**€ 11.95**



Gas Can Ktm/HSQ/Beta/Sherco adapter  
Adattatori tanica per Ktm/HSQ/Beta/Sherco  
**R-GASCANADAPT**

**€ 8.95**

## WORKSHOP-BOX OFFICINA LIQUID MEASURING BEAKERS / MISURINI DOSATORI



**R-MISURCAP100**



**R-MISUR000250**



**R-MISUR000500**



**R-MISUR001000**



| DESCRIPTION                     | COLOR   | CODE                 | PRICE  |
|---------------------------------|---------|----------------------|--------|
| Measuring container 100cc w/Cap | Neutral | <b>R-MISURCAP100</b> | € 5,95 |
| Measuring container 250cc       | Neutral | <b>R-MISUR000250</b> | € 6,95 |
| Measuring container 500cc       | Neutral | <b>R-MISUR000500</b> | € 7,95 |
| Measuring container 1000cc      | Neutral | <b>R-MISUR001000</b> | € 8,95 |



R15 WORX OIL TANK  
capacity 2.56 gal (5 lt.)  
*Tanica 5 lt. raccolta olio*  
**R-R15TANKNR01**

**€ 27.95**



Eco-tank made of PE-HD - It 6  
*Ecotanica raccolta olio in PE-HD litri 6*  
**R-ECOTANKVE06**

**€ 17.95**



Eco-tank made of PE-HD - It 10  
*Ecotanica raccolta olio in PE-HD litri 10*  
**R-ECOTANKVE10**

**€ 19.95**



Eco-tank made of PE-HD - It 12 with funnel  
*Ecotanica plus raccolta olio litri 12 con imbuto*  
**R-ECOTANKVE12**

**€ 27.95**



WORKSHOP-BOX OFFICINA Paddock FLOOR MAT / TAPPETO Paddock

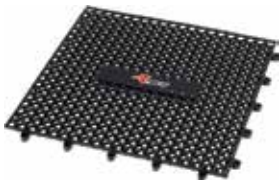

**R-TAPNR000008**

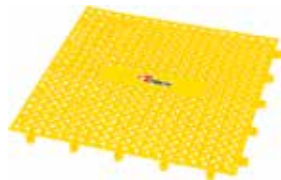

**R-TAPGI000008**



**R-TAPGR000008**



**R-TAPAR000008**

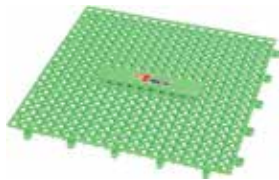

**R-TAPVE000008**



**R-TAPRS000008**



**R-TAPBL000008**



Made by special rubber could be composed as you like and allow to personalize your hospitality.

*Realizzato in speciale gomma termoplastica e componibile a piacimento. Permette di realizzare la propria hospitality in modo esclusivo.*

**€ 59.95/mq (9 pcs)**

**indicare quantità**



### WIRELESS ERASABLE HOUR METER

**Wireless**, vibration activated, no battery or wire connection problems, works on trailers, motors, machinery, equipment.

Two different sensitivity levels, resolution 0.1 Hours.

**Maintenance services:** clean air filter lashes every 5 hours, change oil alert every 10 hours, valve service every 20 hours.

**Partial counter reset.**

Application with 3M double-sided adhesive tape (included)

Total hours can not be reset (up to 999.9 hours).

100% Waterproof IP68, service life 5 years.

Suitable for 2 and 4 stroke engines, one, two or four cylinder.

It is secured using the adhesive backing provided.

Lithium battery - three years of autonomy.

Dimensions 68x33 mm

### CONTAORE ELETTRONICO WIRELESS RESETTABILE

**Wireless** si attiva con la vibrazione. Niente più cavi di collegamento.

Due differenti livelli di sensibilità per adattarsi ad ogni esigenza

Possibilità di **avviso interventi programmati** ogni 5, 10, 20 ore (controllo/cambio olio, regolazione valvole ecc.)

**Tempo funzionamento parziale resettabile.**

Tempo funzionamento totale non resettabile.

Impermeabile.

Adatto a motori 2 e 4 tempi ad uno, due o quattro cilindri.

Si fissa per mezzo del supporto adesivo in dotazione.

Dimensioni 68x33 mm



Red  
HOURMT002RS

€ 38.95



Orange  
HOURMT002AR



Blue  
HOURMT002BL



Yellow  
HOURMT002GI



Green  
HOURMT002VE









Black  
HOURMT002NR

## WORKSHOP-BOX OFFICINA STARTING BLOCKS / BLOCCHI PARTENZA

- Starting blocks risers developed for young and short motocross riders at starting gate
- Configurable in two different versions: 10cm (4 inch) height blocks, or 15cm (6 inch), provide more stability to get better starts
  - Made of strong shockproof plastic, durable and lightweight design
  - Non-slip top surface for better grip
  - Non-slip strong foots for maximum grip on the ground
  - Stackable design, saves space in your vehicle/garage
  - Ergonomic handle for easy transport
- Graphic template available on our website (download/instructions) link or by QR code directly on the package
  - Top surface dimensions: H=100 mm version 200 x 130mm / H=150 mm version 175 x 120mm
  - Base dimensions: 275 x 175mm
  - Total weight for set H=10cm: 590g / H=15cm: 892g
    - Maximum capacity allowed: 250kg
    - Sold as a pair

- *Blocchi di partenza motocross sviluppati per giovani piloti o di bassa statura*
- *Configurabili in due differenti versioni: da 10cm di altezza, o da 15cm, garantiscono più stabilità per partenze migliori*
  - *Prodotto in leggero materiale plastico, robusto ed antiurto*
- *Superficie superiore antiscivolo per un maggior grip* • *4 piedini antiscivolo per garantire la massima presa al terreno*
  - *Impilabile, salva spazio nel tuo veicolo/garage* • *Maniglia ergonomica per un facile trasporto*
- *Tracciato per la grafica disponibile sul nostro sito nella sezione download/istruzioni di montaggio o tramite QR code sulla confezione*
- *Dimensioni piano d'appoggio superiore in versione da 10cm d'altezza: 200 x 130mm / 15cm d'altezza: 175 x 120mm*
  - *Dimensioni base d'appoggio: 275 x 175mm* • *Peso totale per set da 10cm d'altezza: 590g / 15cm d'altezza: 892g*
    - *Portata massima consentita: 250kg*
    - *Venduti a coppia*

|   |   |   |
|---|---|---|
|  |  |  |
| <b>R-REPLOGORVEO</b>  | <b>R-REPLOGORGIO</b>  | <b>R-REPLOGORRSO</b>  |
|  |  |  |
| <b>R-REPLOGORNRO</b>  | <b>R-REPLOGORARO</b>  | <b>R-REPLOGORBLO</b>  |

Set of 4pcs R logo for starting blocks  
Set 4 pezzi logo R per starting block

**€ 8.95**



Personalizable side surfaces with name of rider/team  
*Superfici laterali personalizzabili con nome pilota/team*

**€ 38.95**

**R-BLOCKSGR021**

### OPTIONAL SET SPACER

**€ 19.95**

**R-SPBLOCKSGR3**

SET SPACERS FOR STARTING BLOCKS  
(included 2 X 25mm, 2 X 50mm, 2 X 75mm)

**2 X 75mm**

**2 X 50mm**

**2 X 25mm**



## WORKSHOP-BOX OFFICINA FRONT STRAP / CINGHIA TRAINO

EXTREME ENDURO FRONT STRAP  
CINGHIA DI TRAINO ENDURO EXTREME

R-STRAPNR0018  
€ 14.95



## WORKSHOP-BOX OFFICINA MUFFLER PLUGS / TAPPI MARMITTA



| DESCRIPTION             | COLOR  | CODE          | PRICE  |
|-------------------------|--------|---------------|--------|
| Muffler plug Ø14-42 mm  | Orange | R-TPM001440AR | € 6,95 |
|                         | Blue   | R-TPM001440BL | € 6,95 |
|                         | Yellow | R-TPM001440GI | € 6,95 |
|                         | Black  | R-TPM001440NR | € 6,95 |
|                         | Red    | R-TPM001440RS | € 6,95 |
|                         | Green  | R-TPM001440VE | € 6,95 |
| Muffler plugs Ø40-65 mm | Orange | R-TPM004065AR | € 7,95 |
|                         | Blue   | R-TPM004065BL | € 7,95 |
|                         | Yellow | R-TPM004065GI | € 7,95 |
|                         | Black  | R-TPM004065NR | € 7,95 |
|                         | Red    | R-TPM004065RS | € 7,95 |
|                         | Green  | R-TPM004065VE | € 7,95 |

## WORKSHOP-BOX OFFICINA ALUMINUM FOLDING RAMP RAMPA DI CARICO PIEGHEVOLE

Maximum load capacity 200kg - L 1.83 mt  
Portata max 200kg - L 1.83 mt  
R-RAMP0004501

€ 154.95

Detail  
Dettaglio



Made of aluminum, it is anti-skid thanks to the particular making of its surface.  
Max weight 200 kg.

Realizzata in alluminio.  
Antiscivolo grazie alla particolare lavorazione della sua superficie.  
Carico max 200 kg.

TIE DOWNS

Tie downs with safety lock, width 2,5 cm x length 200 cm. Max load 450 kg

CINGHIE FERMAMOTO

Coppia cinghie con moschettone di sicurezza. Larghezza 25 mm x lunghezza 2 mt. Carico max 450kg.



Detail  
Dettaglio



€ 36.95

Pair of tie downs - Black  
Coppia cinghie fermamoto - Nero  
**R-CINGHIANR25**

REINFORCED TIE DOWNS

- Length 180 cm • Width 3,8 cm
- Max load 550 kg • Safety steel hooks
- Double stitching with heavy duty nylon thread

CINGHIE FERMAMOTO RINFORZATE

- Lunghezza 180 cm • Larghezza 3,8 cm
- Carico max 550 kg • Ganci di sicurezza in acciaio
- Doppia cucitura con filo in nylon



R-CINGHIABL15



R-CINGHIAGI15



R-CINGHIAVE15



R-CINGHIARS15

Pair of tie downs  
Coppia cinghie fermamoto  
**R-CINGHIAAR15**

€ 39.95



New "fat" colored tie downs with double safety snap-hook. Width 3,8 cm, length 180 cm, maximum load 550 kg. Coppia cinghie colorate rinforzate con doppio moschettone di sicurezza. Larghezza 3,8 cm x lunghezza 180 cm. - Carico max 550kg.

| COLOR  | CODE          | DESCRIPTION       | PRICE   |
|--------|---------------|-------------------|---------|
| Yellow | R-CINGHIAGI15 | Pair of tie downs | € 39,95 |
| Green  | R-CINGHIAVE15 | Pair of tie downs | € 39,95 |
| Blue   | R-CINGHIABL15 | Pair of tie downs | € 39,95 |
| Red    | R-CINGHIARS15 | Pair of tie downs | € 39,95 |
| Orange | R-CINGHIAAR15 | Pair of tie downs | € 39,95 |



**TRACK MARKER**

RTech track markers are made from a flexible anti-shock material and feature a rear safety lace.

**PALETTO DELINEATORE DI PERCORSO**

Realizzato in materiale flessibile antiurto, di colore bianco con logo IPL co-stampato personalizzabile incluso.

Il laccio di sicurezza posteriore evita che la fettuccia si liberi lungo il percorso in caso di rottura.

**CUSTOMIZABLE!! ON REQUEST**

Minimun quantity 1000pz

**PERSONALIZZABILE!! A RICHIESTA**

Quantità minima 1000pz



MX OF NATIONS  
FRANCE 2011



MX OF NATIONS  
ITALY 2009



R-PALBN000000

€ 2.95

**TRACK MARKER STAKE HAMMER**

Ergonomically designed and constructed from galvanized steel, this tool is an essential tool for track marker placement.

**BATTIPALETTO**

Battipaletto in acciaio zincato con impugnatura ergonomica appositamente studiato per i paletti segnapercorso Rtech. Accessorio indispensabile per la tracciatura.



R-BATPALAC000

€ 32.95

**WORKSHOP-BOX OFFICINA TRACK TAPE / FETTUCCIA PERCORSO**

Thickness: 100 micron - Polyethylene PE-LD - Height 9,5 cm

Printing on one side - 1 KG = 120 MT

Spessore 100 micron - Fettuccia in polietilene PE-LD - Altezza 9,5 cm

Stampa su un lato - 1 KG = 120 MT

| COLOR       | CODE            | PRICE  |
|-------------|-----------------|--------|
| White-Black | R-FETTUCCIABNNR | € 9,95 |
| White-Red   | R-FETTUCCIABNRS | € 9,95 |

**EXTRA-STRONG**



## WORKSHOP-BOX OFFICINA PIT BOARD / TABELLA SEGNALAZIONE

**new increased thickness to 5mm**  
**nuovo spessore aumentato a 5mm**

New pit board with erasable white side.  
 Made of light and anti shock plastic material.  
 Supplied with erasable marking pen.

*Tabella di segnalazione con lato bianco cancellabile.*  
*Realizzata in materiale plastico antiurto di spessore 5 mm.*  
*Fornita con pennarello cancellabile.*



Pit board with marking pen - white/black color  
 Tabella segnalazione con pennarello - bianco/nero  
**R-LAVSRTNR1**

**€ 47.95**



Black marking pen  
 Pennarello nero per tabella segnalazione  
**R-PENLAVNR1**

**€ 6.95**



## WORKSHOP-BOX OFFICINA PVC NUMBER STICKER / NUMERI ADESIVI IN PVC

**0123456789**



| DESCRIPTION                  | COLOR | CODE                 | PRICE   |
|------------------------------|-------|----------------------|---------|
| PVC number stikers N°0 10PCS | Black | <b>R-NUMSIZ100NR</b> | € 12,95 |
| PVC number stikers N°1 10PCS | Black | <b>R-NUMSIZ101NR</b> | € 12,95 |
| PVC number stikers N°2 10PCS | Black | <b>R-NUMSIZ102NR</b> | € 12,95 |
| PVC number stikers N°3 10PCS | Black | <b>R-NUMSIZ103NR</b> | € 12,95 |
| PVC number stikers N°4 10PCS | Black | <b>R-NUMSIZ104NR</b> | € 12,95 |
| PVC number stikers N°5 10PCS | Black | <b>R-NUMSIZ105NR</b> | € 12,95 |
| PVC number stikers N°6 10PCS | Black | <b>R-NUMSIZ106NR</b> | € 12,95 |
| PVC number stikers N°7 10PCS | Black | <b>R-NUMSIZ107NR</b> | € 12,95 |
| PVC number stikers N°8 10PCS | Black | <b>R-NUMSIZ108NR</b> | € 12,95 |
| PVC number stikers N°9 10PCS | Black | <b>R-NUMSIZ109NR</b> | € 12,95 |

| DESCRIPTION                            | COLOR | CODE                 | PRICE    |
|--|-------|----------------------|----------|
| PVC number stikers - N° 0 > 9 - 10 pcs | Black | <b>R-NUMSIZ1NRSE</b> | € 119,95 |





## **FUEL SYSTEM**

*Tank caps >pag 278*

*Fuel hose breather >pag 278*

*Gas tank valve >pag 278*

*Air filter >pag 279*

*Bio wash kit >pag 283*

*Airbox cover >pag 284*

*Anti-slosh fuel foam >pag 286*

## **SEAT FOAMS**

*Seat cover >pag 287*

*Seat foams >pag 287*



## BI-MATERIAL TANK CAPS

Rtech gas caps are co-injected utilizing a dual-compound material with a soft-touch upper material and solid internal valve. This process assures incredible light weight and a great look. A new generation of gas caps.

## TAPPI SERBATOIO BI-MATERIALE

Realizzati in bimateriale co-stampato con parte superiore ad effetto soft touch antiscivolo e valvola di tenuta interna, garantiscono la massima leggerezza ed un look moderno per la vostra moto.



R-TAPPOYZFBL9



R-TAPPORMZRS9



R-TAPPORMZGI9



R-TAPPOYZFVE9

€ 19.95

| BRAND            | MODEL        | CC                  | YEAR         | COLOR           | CODE            | PRICE   |
|------------------|--------------|---------------------|--------------|-----------------|-----------------|---------|
| REPLICA HONDA    | CRF          | 250                 | 2004 > 2017  | Black-CR Red    | R-TAPPOCRFRS9   | € 19,95 |
|                  | CRF          | 450                 | 2002 > 2016  | Black-CR Red    | R-TAPPOCRFRS9   | € 19,95 |
|                  | CRFX         | 250                 | 2004 > 2019  | Black-CR Red    | R-TAPPOCRFRS9   | € 19,95 |
|                  | CRFX         | 450                 | 2004 > 2017  | Black-CR Red    | R-TAPPOCRFRS9   | € 19,95 |
|                  | TRX          | 250-300-400-450-700 | 1999 > 2023  | Black-CR Red    | R-TAPPOCRFRS9   | € 19,95 |
| REPLICA TM       | EN / MX / SM | 125 > 450           | 2008 > 2014  | Black-TM Blue   | R-TAPPOCRFBTLM9 | € 19,95 |
| REPLICA KAWASAKI | KX           | 125-250             | 1999 > 2008  | Black-CR Red    | R-TAPPORMZRS9   | € 19,95 |
|                  | KXF          | 250                 | 2004 > 2016  | Black-KX Green  | R-TAPPOYZFVE9   | € 19,95 |
|                  | KXF          | 450                 | 2006 > 2015  | Black-KX Green  | R-TAPPOYZFVE9   | € 19,95 |
| REPLICA SUZUKI   | RM           | 125-250             | 2000 > 2011  | Black-RM Yellow | R-TAPPORMZGI9   | € 19,95 |
|                  |              |                     |              | Black-CR Red    | R-TAPPORMZRS9   |         |
|                  | RM           | 65-85-100           | 2002 > 2023  | Black-RM Yellow | R-TAPPORMZGI9   | € 19,95 |
|                  |              |                     |              | Black-CR Red    | R-TAPPORMZRS9   |         |
|                  | RMZ          | 250                 | 2010 > 2018  | Black-RM Yellow | R-TAPPORMZGI9   | € 19,95 |
|                  |              |                     |              | Black-CR Red    | R-TAPPORMZRS9   |         |
|                  | RMZ          | 450                 | 2005 > 2017  | Black-RM Yellow | R-TAPPORMZGI9   | € 19,95 |
|                  |              |                     | Black-CR Red | R-TAPPORMZRS9   |                 |         |
|                  | RMZX         | 450                 | 2010 > 2019  | Black-RM Yellow | R-TAPPORMZGI9   | € 19,95 |
|                  |              |                     |              | Black-CR Red    | R-TAPPORMZRS9   |         |
| REPLICA YAMAHA   | YZ           | 125-250             | 1998 > 2023  | Black-YZ Blue   | R-TAPPOYZFBL9   | € 19,95 |
|                  | YZ-X         | 125-250             | 2016 > 2023  | Black-YZ Blue   | R-TAPPOYZFBL9   | € 19,95 |
|                  | YZF          | 250-450             | 1998 > 2013  | Black-YZ Blue   | R-TAPPOYZFBL9   | € 19,95 |



€ 11.95

## FUEL HOSE BREATHER / TUBO SFIATO BENZINA

Fuel vent hose with non-return valve - Length 36 cm

Tubo sfiato benzina con valvola di non ritorno - Lunghezza 36 cm

| COLOR  | CODE           | PRICE   |
|--------|----------------|---------|
| Orange | R-VALVSF0001AR | € 11,95 |
| Blue   | R-VALVSF0001BL | € 11,95 |
| Yellow | R-VALVSF0001GI | € 11,95 |
| Red    | R-VALVSF0001RS | € 11,95 |
| Green  | R-VALVSF0001VE | € 11,95 |



€ 11.95

R-VALVSF000AR R-VALVSF000BL R-VALVSF000RS

## GAS TANK VALVE / VALVOLE SFIATO SERBATOIO

| COLOR  | CODICE        | PRICE   |
|--------|---------------|---------|
| Orange | R-VALVSF000AR | € 11,95 |
| Blue   | R-VALVSF000BL | € 11,95 |
| Red    | R-VALVSF000RS | € 11,95 |

## FUEL SYSTEM-ALIMENTAZIONE DOUBLE LAYER AIR FILTERS / FILTRI ARIA DOPPIO STRATO



They assure the greatest permeability by keeping the smallest impurity. Available also in fireproof version.

*Filtri aria a doppio strato, garantiscono la massima permeabilità trattenendo le più piccole impurità. Disponibili anche in versione ignifuga.*

| BRAND           | MODEL        | CC          | YEAR        | NOTES     | COLOR         | CODE          | PRICE         |         |
|-----------------|--------------|-------------|-------------|-----------|---------------|---------------|---------------|---------|
| HONDA           | CR           | 80          | 1984 > 2002 |           | Neutral       | R-FLTCR010085 | € 24,95       |         |
|                 | CR           | 85          | 2003 > 2007 |           | Neutral       | R-FLTCR010085 | € 24,95       |         |
|                 | CR           | 125         | 1989 > 1997 |           | Neutral       | R-FLTCR008999 | € 24,95       |         |
|                 | CR           | 125         | 1998 > 2007 |           | Neutral       | R-FLTCR012502 | € 24,95       |         |
|                 | CR           | 250         | 1989 > 1996 |           | Neutral       | R-FLTCR008999 | € 24,95       |         |
|                 | CR           | 250         | 1997 > 2007 |           | Neutral       | R-FLTCR012502 | € 24,95       |         |
|                 | CRF          | 150         | 2007 > 2023 |           | Neutral       | R-FLTCRF15007 | € 24,95       |         |
|                 | CRF          | 250         | 2004 > 2009 |           | Neutral       | R-FLTCRF45003 | € 24,95       |         |
|                 |              |             |             |           | Fireproof     | Neutral       | R-FLTCRFI4503 | € 27,95 |
|                 | CRF          | 250         | 2010 > 2013 |           | Neutral       | R-FLTCRF45009 | € 24,95       |         |
|                 |              |             |             |           | Fireproof     | Neutral       | R-FLTCRFI4509 | € 27,95 |
|                 | CRF          | 250         | 2014 > 2017 |           | Neutral       | R-FLTCRF45013 | € 24,95       |         |
|                 |              |             |             |           | Fireproof     | Neutral       | R-FLTCRFI4513 | € 27,95 |
|                 | CRF          | 250         | 2018 > 2021 |           | Neutral       | R-FLTCRF45017 | € 24,95       |         |
|                 |              |             |             |           | Fireproof     | Neutral       | R-FLTCRFI4517 | € 27,95 |
|                 | CRF / CRF-RX | 250         | 2022-2023   |           | Neutral       | R-FLTCRF45021 | € 24,95       |         |
|                 |              |             |             |           | Fireproof     | Neutral       | R-FLTCRFI4521 | € 27,95 |
|                 | CRF          | 450         | 2002        |           | Neutral       | R-FLTCRF45002 | € 24,95       |         |
|                 | CRF          | 450         | 2003 > 2008 |           | Neutral       | R-FLTCRF45003 | € 24,95       |         |
|                 |              |             |             |           | Fireproof     | Neutral       | R-FLTCRFI4503 | € 27,95 |
|                 | CRF          | 450         | 2009 > 2012 |           | Neutral       | R-FLTCRF45009 | € 24,95       |         |
|                 |              |             |             |           | Fireproof     | Neutral       | R-FLTCRFI4509 | € 27,95 |
|                 | CRF          | 450         | 2013 > 2016 |           | Neutral       | R-FLTCRF45013 | € 24,95       |         |
|                 |              |             |             |           | Fireproof     | Neutral       | R-FLTCRFI4513 | € 27,95 |
|                 | CRF-RX       | 250         | 2019 > 2021 |           | Neutral       | R-FLTCRF45017 | € 24,95       |         |
|                 |              |             |             |           | Fireproof     | Neutral       | R-FLTCRFI4517 | € 27,95 |
|                 | CRF / CRF-RX | 450         | 2017 > 2020 |           | Neutral       | R-FLTCRF45017 | € 24,95       |         |
|                 |              |             |             | Fireproof | Neutral       | R-FLTCRFI4517 | € 27,95       |         |
| CRF / CRF-RWE   | 450          | 2021 > 2023 |             | Neutral   | R-FLTCRF45021 | € 24,95       |               |         |
|                 |              |             |             | Fireproof | Neutral       | R-FLTCRFI4521 | € 27,95       |         |
| CRF-RX          | 450          | 2021 > 2023 |             | Neutral   | R-FLTCRF45021 | € 24,95       |               |         |
|                 |              |             |             | Fireproof | Neutral       | R-FLTCRFI4521 | € 27,95       |         |
| CRFX            | 250          | 2004 > 2019 |             | Neutral   | R-FLTCRF45003 | € 24,95       |               |         |
|                 |              |             |             | Fireproof | Neutral       | R-FLTCRFI4503 | € 27,95       |         |
| CRFX            | 450          | 2005 > 2017 |             | Neutral   | R-FLTCRF45003 | € 24,95       |               |         |
|                 |              |             |             | Fireproof | Neutral       | R-FLTCRFI4503 | € 27,95       |         |
| CRF - L / CRF-X | 450          | 2019 > 2023 |             | Neutral   | R-FLTCRF45017 | € 24,95       |               |         |
|                 |              |             |             | Fireproof | Neutral       | R-FLTCRFI4517 | € 27,95       |         |
| XR              | 250          | 1987 > 2009 |             | Neutral   | R-FLTXR000085 | € 24,95       |               |         |
| XR              | 400          | 1996 > 2009 |             | Neutral   | R-FLTXR000085 | € 24,95       |               |         |
| XR              | 600          | 1987 > 2002 |             | Neutral   | R-FLTXR000085 | € 24,95       |               |         |
| XR              | 650          | 1996 > 2009 |             | Neutral   | R-FLTXR650096 | € 24,95       |               |         |
| YAMAHA          | WRF          | 250         | 2003 > 2014 |           | Neutral       | R-FLTWRF45003 | € 24,95       |         |
|                 | WRF          | 250         | 2015 > 2019 |           | Neutral       | R-FLTYZF25014 | € 24,95       |         |
|                 |              |             |             |           | Fireproof     | Neutral       | R-FLTYZF25114 | € 27,95 |
|                 | WRF          | 250         | 2020>2023   |           | Neutral       | R-FLTYZF45018 | € 24,95       |         |
|                 |              |             |             |           | Fireproof     | Neutral       | R-FLTYZF45118 | € 27,95 |
|                 | WRF          | 450         | 2003 > 2015 |           | Neutral       | R-FLTWRF45003 | € 24,95       |         |
|                 | WRF          | 450         | 2016 > 2018 |           | Neutral       | R-FLTYZF25014 | € 24,95       |         |
|                 |              |             |             |           | Fireproof     | Neutral       | R-FLTYZF25114 | € 27,95 |
|                 | WRF          | 450         | 2019 > 2023 |           | Neutral       | R-FLTYZF45018 | € 24,95       |         |
|                 |              |             |             |           | Fireproof     | Neutral       | R-FLTYZF45118 | € 27,95 |
|                 | YZF          | 250         | 2014 > 2018 |           | Neutral       | R-FLTYZF25014 | € 24,95       |         |
|                 |              |             |             |           | Fireproof     | Neutral       | R-FLTYZF25114 | € 24,95 |
|                 | YZF          | 250         | 2019 > 2023 |           | Neutral       | R-FLTYZF45018 | € 24,95       |         |
|                 |              |             |             |           | Fireproof     | Neutral       | R-FLTYZF45118 | € 27,95 |
| YZ              | 65           | 2018 > 2023 |             | Neutral   | R-FLTYZ650018 | € 24,95       |               |         |
| YZ              | 85           | 2002 > 2023 |             | Neutral   | R-FLTYZ850002 | € 24,95       |               |         |
| YZ              | 125-250      | 1997 > 2023 |             | Neutral   | R-FLTYZ125001 | € 24,95       |               |         |
|                 |              |             |             | Fireproof | Neutral       | R-FLTYZFI0000 | € 27,95       |         |

# FUEL SYSTEM-ALIMENTAZIONE DOUBLE LAYER AIR FILTERS / FILTRI ARIA DOPPIO STRATO

| BRAND           | MODEL | CC          | YEAR                  | NOTES     | COLOR   | CODE          | PRICE   |
|-----------------|-------|-------------|-----------------------|-----------|---------|---------------|---------|
|                 | YZF   | 250         | 2001 > 2013           |           | Neutral | R-FLTYZ125001 | € 24,95 |
|                 |       |             |                       | Fireproof | Neutral | R-FLTYZF10000 | € 27,95 |
|                 | YZF   | 450         | 2010 > 2013           | Fireproof | Neutral | R-FLTYZ451010 | € 27,95 |
|                 |       |             |                       |           | Neutral | R-FLTYZF45010 | € 24,95 |
|                 | YZF   | 450         | 2014 > 2017           |           | Neutral | R-FLTYZF25014 | € 24,95 |
|                 |       |             |                       | Fireproof | Neutral | R-FLTYZF25114 | € 27,95 |
|                 | YZF   | 450         | 2018 > 2022           |           | Neutral | R-FLTYZF45018 | € 24,95 |
|                 |       |             |                       | Fireproof | Neutral | R-FLTYZF45118 | € 27,95 |
| <b>NEW</b>      | YZF   | 450         | 2023                  |           | Neutral | R-FLTYZF45023 | € 24,95 |
|                 |       |             |                       | Fireproof | Neutral | R-FLTYZF45123 | € 27,95 |
|                 | YZF   | 400-426-450 | 1998 > 2009           |           | Neutral | R-FLTYZ125001 | € 24,95 |
|                 |       |             |                       | Fireproof | Neutral | R-FLTYZF10000 | € 27,95 |
|                 | YZ-X  | 125         | 2020 > 2023           |           | Neutral | R-FLTYZ125001 | € 24,95 |
|                 |       |             |                       | Fireproof | Neutral | R-FLTYZF10000 | € 27,95 |
|                 | YZ-X  | 250         | 2016 > 2023           |           | Neutral | R-FLTYZ125001 | € 24,95 |
|                 |       |             |                       | Fireproof | Neutral | R-FLTYZF10000 | € 27,95 |
|                 | YZ-FX | 250         | 2015 > 2019           |           | Neutral | R-FLTYZF25014 | € 24,95 |
|                 |       |             |                       | Fireproof | Neutral | R-FLTYZF25114 | € 27,95 |
|                 | YZ-FX | 250         | 2020 > 2023           |           | Neutral | R-FLTYZF45018 | € 24,95 |
|                 |       |             |                       | Fireproof | Neutral | R-FLTYZF45118 | € 27,95 |
|                 | YZ-FX | 450         | 2015 > 2018           |           | Neutral | R-FLTYZF25014 | € 24,95 |
|                 |       |             |                       | Fireproof | Neutral | R-FLTYZF25114 | € 27,95 |
|                 | YZ-FX | 450         | 2019 > 2023           |           | Neutral | R-FLTYZF45018 | € 24,95 |
|                 |       |             |                       | Fireproof | Neutral | R-FLTYZF45118 | € 27,95 |
| <b>KAWASAKI</b> | KX    | 65          | 2000 > 2023           |           | Neutral | R-FLTKX650001 | € 24,95 |
|                 | KX    | 80          | 1991 > 2000           |           | Neutral | R-FLTKX850098 | € 24,95 |
|                 | KX    | 85-100-112  | 2001 > 2023           |           | Neutral | R-FLTKX850098 | € 24,95 |
|                 | KX    | 125-250     | 1990 > 91 - 1994 > 09 |           | Neutral | R-FLTKX000002 | € 24,95 |
|                 | KXF   | 250         | 2004-2005             |           | Neutral | R-FLTKXF00405 | € 24,95 |
|                 | KXF   | 250         | 2006 > 2016           |           | Neutral | R-FLTKXF45006 | € 24,95 |
|                 |       |             |                       | Fireproof | Neutral | R-FLTKXF10006 | € 27,95 |
|                 | KXF   | 250         | 2017 > 2020           |           | Neutral | R-FLTKXF45016 | € 24,95 |
|                 |       |             |                       | Fireproof | Neutral | R-FLTKXF10016 | € 27,95 |
|                 | KXF   | 250         | 2021 > 2023           |           | Neutral | R-FLTKXF45019 | € 24,95 |
|                 |       |             |                       | Fireproof | Neutral | R-FLTKXF45119 | € 27,95 |
|                 | KXF   | 450         | 2006 > 2015           |           | Neutral | R-FLTKXF45006 | € 24,95 |
|                 |       |             |                       | Fireproof | Neutral | R-FLTKXF10006 | € 27,95 |
|                 | KXF   | 450         | 2016 > 2018           |           | Neutral | R-FLTKXF45016 | € 24,95 |
|                 |       |             |                       | Fireproof | Neutral | R-FLTKXF10016 | € 27,95 |
|                 | KXF   | 450         | 2019 > 2023           |           | Neutral | R-FLTKXF45019 | € 24,95 |
|                 |       |             |                       | Fireproof | Neutral | R-FLTKXF45119 | € 27,95 |
|                 | KX-XC | 250-450     | 2021 > 2023           |           | Neutral | R-FLTKXF45019 | € 24,95 |
|                 |       |             |                       | Fireproof | Neutral | R-FLTKXF45119 | € 27,95 |
|                 | KLXR  | 450         | 2007 > 2016           |           | Neutral | R-FLTKLX45007 | € 24,95 |
| <b>SUZUKI</b>   | RM    | 65          | 2003 > 2006           |           | Neutral | R-FLTKX650001 | € 24,95 |
|                 | RM    | 80          | 1986 > 2001           |           | Neutral | R-FLTRM850000 | € 24,95 |
|                 | RM    | 85          | 2002 > 2023           |           | Neutral | R-FLTRM850000 | € 24,95 |
|                 | RM    | 125         | 2002-2003             |           | Neutral | R-FLTRM125023 | € 24,95 |
|                 | RM    | 125         | 2004 > 2009           |           | Neutral | R-FLTYZ125001 | € 24,95 |
|                 |       |             |                       | Fireproof | Neutral | R-FLTYZF10000 | € 27,95 |
|                 | RM    | 250         | 2002                  |           | Neutral | R-FLTRM125023 | € 24,95 |
|                 | RM    | 250         | 2003 > 2009           |           | Neutral | R-FLTYZ125001 | € 24,95 |
|                 |       |             |                       | Fireproof | Neutral | R-FLTYZF10000 | € 27,95 |
|                 | RMXZ  | 450         | 2010 > 2019           |           | Neutral | R-FLTRMX45010 | € 24,95 |
|                 | RMZ   | 250         | 2004 > 2006           |           | Neutral | R-FLTKXF00405 | € 24,95 |
|                 | RMZ   | 250         | 2007 > 2018           |           | Neutral | R-FLTYZ125001 | € 24,95 |
|                 |       |             |                       | Fireproof | Neutral | R-FLTYZF10000 | € 27,95 |
|                 | RMZ   | 250         | 2019 > 2023           |           | Neutral | R-FLTRMZ45018 | € 24,95 |
|                 |       |             |                       | Fireproof | Neutral | R-FLTRMZ45118 | € 27,95 |
|                 | RMZ   | 450         | 2005 > 2017           |           | Neutral | R-FLTYZ125001 | € 24,95 |
|                 |       |             |                       | Fireproof | Neutral | R-FLTYZF10000 | € 27,95 |
|                 | RMZ   | 450         | 2018 > 2023           |           | Neutral | R-FLTRMZ45018 | € 24,95 |
|                 |       |             |                       | Fireproof | Neutral | R-FLTRMZ45118 | € 27,95 |
|                 | DRZ   | 250 > 400   | 2000 > 2009           |           | Neutral | R-FLDRZ00000  | € 24,95 |
| <b>KTM</b>      | SX    | 65          | 1997 > 2023           |           | Neutral | R-FLTKTM65097 | € 24,95 |
|                 | SX    | 85          | 2003 > 2004           | 1 Hole    | Neutral | R-FLTKTM28504 | € 24,95 |
|                 | SX    | 85          | 2005 > 2012           | Fireproof | Neutral | R-FLTKTM14T00 | € 27,95 |
|                 |       |             |                       | 3 Holes   | Neutral | R-FLTKTM00005 | € 24,95 |
|                 | SX    | 85          | 2013 > 2017           |           | Neutral | R-FLTKTM00085 | € 24,95 |
|                 | SX    | 85          | 2018 > 2023           |           | Neutral | R-FLTKTM01885 | € 24,95 |
|                 | SX    | 105         | 2006 > 2010           | Fireproof | Neutral | R-FLTKTM14T00 | € 27,95 |
|                 |       |             |                       | 3 Holes   | Neutral | R-FLTKTM00005 | € 24,95 |
|                 | SX    | 125         | 1998 > 2002           | 1 Hole    | Neutral | R-FLTKTM28504 | € 24,95 |
|                 | SX    | 125         | 2003 > 2006           | Fireproof | Neutral | R-FLTKTM14T00 | € 27,95 |
|                 |       |             |                       | 3 Holes   | Neutral | R-FLTKTM00005 | € 24,95 |
|                 | SX    | 144         | 2007 > 2008           | Fireproof | Neutral | R-FLTKTMISXF7 | € 27,95 |
|                 |       |             |                       |           | Neutral | R-FLTKTMSXF07 | € 24,95 |
|                 | SX    | 150         | 2009 > 2010           | Fireproof | Neutral | R-FLTKTMSXF7  | € 27,95 |
|                 |       |             |                       |           | Neutral | R-FLTKTMSXF07 | € 24,95 |
|                 | SX    | 200         | 2003 > 2004           | Fireproof | Neutral | R-FLTKTM14T00 | € 27,95 |
|                 |       |             |                       | 3 Holes   | Neutral | R-FLTKTM00005 | € 24,95 |
|                 | SX    | 250 2T      | 1985 > 2002           | 1 Hole    | Neutral | R-FLTKTM28504 | € 24,95 |

## FUEL SYSTEM-ALIMENTAZIONE DOUBLE LAYER AIR FILTERS / FILTRI ARIA DOPPIO STRATO

| BRAND      | MODEL               | CC                     | YEAR                | NOTES                | COLOR   | CODE          | PRICE   |
|------------|---------------------|------------------------|---------------------|----------------------|---------|---------------|---------|
|            | SX                  | 250                    | 2003 > 2007         | Fireproof<br>3 Holes | Neutral | R-FLTMTI4T00  | € 27,95 |
|            |                     |                        |                     |                      | Neutral | R-FLTMTM00005 | € 24,95 |
|            | SX / SXF            | 125-250                | 2007 > 2010         | Fireproof            | Neutral | R-FLTMTMISXF7 | € 27,95 |
|            |                     |                        |                     |                      | Neutral | R-FLTMTMSXF07 | € 24,95 |
|            | SX                  | 125-150                | 2011 > 2015         | Fireproof            | Neutral | R-FLTMTMISXF1 | € 27,95 |
|            |                     |                        |                     |                      | Neutral | R-FLTMTMSXF11 | € 24,95 |
|            | SX                  | 125-150                | 2016 > 2022         | Fireproof            | Neutral | R-FLTMTMISXF6 | € 27,95 |
|            |                     |                        |                     |                      | Neutral | R-FLTMTMSXF16 | € 24,95 |
| <b>NEW</b> | SX                  | 125-250-300            | 2023                | Fireproof            | Neutral | R-FLTMTMISXF3 | € 27,95 |
|            |                     |                        |                     |                      | Neutral | R-FLTMTMSXF23 | € 24,95 |
|            | SX                  | 250                    | 2007 > 2010         | Fireproof            | Neutral | R-FLTMTMISXF7 | € 27,95 |
|            |                     |                        |                     |                      | Neutral | R-FLTMTMSXF07 | € 24,95 |
|            | SX                  | 250                    | 2012 > 2016         | Fireproof            | Neutral | R-FLTMTMISXF1 | € 27,95 |
|            |                     |                        |                     |                      | Neutral | R-FLTMTMSXF11 | € 24,95 |
|            | SX                  | 250                    | 2017 > 2022         | Fireproof            | Neutral | R-FLTMTMISXF6 | € 27,95 |
|            |                     |                        |                     |                      | Neutral | R-FLTMTMSXF16 | € 24,95 |
|            | SX                  | 400                    | 2000 > 2002         | 1 Hole               | Neutral | R-FLTMTM28504 | € 24,95 |
|            | SX                  | 520                    | 1998 > 2000         | 1 Hole               | Neutral | R-FLTMTM28504 | € 24,95 |
|            | SX                  | 520                    | 1999 > 2002         | Fireproof<br>3 Holes | Neutral | R-FLTMTMI4T00 | € 27,95 |
|            |                     |                        |                     |                      | Neutral | R-FLTMTM00005 | € 24,95 |
|            | SXC                 | 540                    | 2000 > 2004         | Fireproof<br>3 Holes | Neutral | R-FLTMTMI4T00 | € 27,95 |
|            |                     |                        |                     |                      | Neutral | R-FLTMTM00005 | € 24,95 |
|            | SX / EXC<br>SXF     | 250-300-360-380<br>250 | 1998 > 2002<br>2005 | 1 Hole<br>Fireproof  | Neutral | R-FLTMTM28504 | € 24,95 |
|            |                     |                        |                     |                      | Neutral | R-FLTMTMI4T00 | € 27,95 |
|            |                     |                        |                     |                      | Neutral | R-FLTMTM00005 | € 24,95 |
|            | SXF                 | 450                    | 2003 > 2006         | Fireproof<br>3 Holes | Neutral | R-FLTMTMI4T00 | € 27,95 |
|            |                     |                        |                     |                      | Neutral | R-FLTMTM00005 | € 24,95 |
|            | SXF                 | 450                    | 2009 > 2012         | Fireproof            | Neutral | R-FLTMTMISXF7 | € 27,95 |
|            |                     |                        |                     |                      | Neutral | R-FLTMTMSXF07 | € 24,95 |
|            | SX                  | 525                    | 2003 > 2006         | Fireproof<br>3 Holes | Neutral | R-FLTMTMI4T00 | € 27,95 |
|            |                     |                        |                     |                      | Neutral | R-FLTMTM00005 | € 24,95 |
|            | SXF                 | 250-350-450            | 2011 > 2015         | Fireproof            | Neutral | R-FLTMTMISXF1 | € 27,95 |
|            |                     |                        |                     |                      | Neutral | R-FLTMTMSXF11 | € 24,95 |
|            | SXF/XCF             | 250-350-450            | 2016 > 2022         | Fireproof            | Neutral | R-FLTMTMISXF6 | € 27,95 |
|            |                     |                        |                     |                      | Neutral | R-FLTMTMSXF16 | € 24,95 |
| <b>NEW</b> | SXF                 | 250-350-450            | 2023                | Fireproof            | Neutral | R-FLTMTMISXF3 | € 27,95 |
|            |                     |                        |                     |                      | Neutral | R-FLTMTMSXF23 | € 24,95 |
|            | SXF Factory Edition | 250-450                | 2022                | Fireproof            | Neutral | R-FLTMTMISXF3 | € 27,95 |
|            |                     |                        |                     |                      | Neutral | R-FLTMTMSXF23 | € 24,95 |
|            | SXF                 | 505                    | 2007 > 2009         | Fireproof            | Neutral | R-FLTMTMISXF7 | € 27,95 |
|            |                     |                        |                     |                      | Neutral | R-FLTMTMSXF07 | € 24,95 |
|            | EXC                 | 125                    | 1998 > 2003         | 1 Hole               | Neutral | R-FLTMTM28504 | € 24,95 |
|            | EXC                 | 125                    | 2004 > 2007         | Fireproof<br>3 Holes | Neutral | R-FLTMTMI4T00 | € 27,95 |
|            |                     |                        |                     |                      | Neutral | R-FLTMTM00005 | € 24,95 |
|            | EXC                 | 125                    | 2008 > 2011         | Fireproof            | Neutral | R-FLTMTMISXF7 | € 27,95 |
|            |                     |                        |                     |                      | Neutral | R-FLTMTMSXF07 | € 24,95 |
|            | EXC                 | 200                    | 2002 > 2004         | Fireproof<br>3 Holes | Neutral | R-FLTMTMI4T00 | € 27,95 |
|            |                     |                        |                     |                      | Neutral | R-FLTMTM00005 | € 24,95 |
|            | EXC                 | 200-250-300            | 2008 > 2011         | Fireproof            | Neutral | R-FLTMTMISXF7 | € 27,95 |
|            |                     |                        |                     |                      | Neutral | R-FLTMTMSXF07 | € 24,95 |
|            | EXC                 | 250                    | 2003 > 2007         | Fireproof<br>3 Holes | Neutral | R-FLTMTMI4T00 | € 27,95 |
|            |                     |                        |                     |                      | Neutral | R-FLTMTM00005 | € 24,95 |
|            | EXC RACING          | 250                    | 2001 > 2006         | Fireproof<br>3 Holes | Neutral | R-FLTMTMI4T00 | € 27,95 |
|            |                     |                        |                     |                      | Neutral | R-FLTMTM00005 | € 24,95 |
|            | EXC                 | 300                    | 2004 > 2007         | Fireproof<br>3 Holes | Neutral | R-FLTMTMI4T00 | € 27,95 |
|            |                     |                        |                     |                      | Neutral | R-FLTMTM00005 | € 24,95 |
|            | EXC                 | 380                    | 1998 > 2002         | Fireproof<br>3 Holes | Neutral | R-FLTMTMI4T00 | € 27,95 |
|            |                     |                        |                     |                      | Neutral | R-FLTMTM00005 | € 24,95 |
|            | EXC                 | 450                    | 2003 > 2007         | Fireproof<br>3 Holes | Neutral | R-FLTMTMI4T00 | € 27,95 |
|            |                     |                        |                     |                      | Neutral | R-FLTMTM00005 | € 24,95 |
|            | EXC / EXCF          | 125 > 500              | 2012 > 2016         | Fireproof            | Neutral | R-FLTMTMISXF1 | € 27,95 |
|            |                     |                        |                     |                      | Neutral | R-FLTMTMSXF11 | € 24,95 |
|            | EXC                 | 520                    | 2001 > 2002         | Fireproof<br>3 Holes | Neutral | R-FLTMTMI4T00 | € 27,95 |
|            |                     |                        |                     |                      | Neutral | R-FLTMTM00005 | € 24,95 |
|            | EXCF                | 250                    | 2007                | Fireproof<br>3 Holes | Neutral | R-FLTMTMI4T00 | € 27,95 |
|            |                     |                        |                     |                      | Neutral | R-FLTMTM00005 | € 24,95 |
|            | EXCF                | 250-400-530            | 2008 > 2011         | Fireproof            | Neutral | R-FLTMTMISXF7 | € 27,95 |
|            |                     |                        |                     |                      | Neutral | R-FLTMTMSXF07 | € 24,95 |
|            | EXC / EXCF / XC-W   | 250-300-350-450-500    | 2017 > 2023         | Fireproof            | Neutral | R-FLTMTMISXF6 | € 27,95 |
|            |                     |                        |                     |                      | Neutral | R-FLTMTMSXF16 | € 24,95 |
|            | XC-W                | 125-150                | 2017 > 2023         | Fireproof            | Neutral | R-FLTMTMISXF6 | € 27,95 |
|            |                     |                        |                     |                      | Neutral | R-FLTMTMSXF16 | € 24,95 |
| <b>NEW</b> | XC / XCF            | 125-250-300-350-450    | 2023                | Fireproof            | Neutral | R-FLTMTMISXF3 | € 27,95 |
|            |                     |                        |                     |                      | Neutral | R-FLTMTMSXF23 | € 24,95 |
|            | XC                  | 105                    | 2008-2009           | Fireproof<br>3 Holes | Neutral | R-FLTMTMI4T00 | € 27,95 |
|            |                     |                        |                     |                      | Neutral | R-FLTMTM00005 | € 24,95 |
|            | XC                  | 150                    | 2010                | Fireproof            | Neutral | R-FLTMTMISXF7 | € 27,95 |
|            |                     |                        |                     |                      | Neutral | R-FLTMTMSXF07 | € 24,95 |
|            | XC                  | 380                    | 1998 > 2002         |                      | Neutral | R-FLTMTM28504 | € 24,95 |
|            | XC SPORT ATV        | 450                    | 2008 > 2009         | Fireproof            | Neutral | R-FLTMTMISXF7 | € 27,95 |
|            |                     |                        |                     |                      | Neutral | R-FLTMTMSXF07 | € 24,95 |

## FUEL SYSTEM-ALIMENTAZIONE DOUBLE LAYER AIR FILTERS / FILTRI ARIA DOPPIO STRATO

| BRAND            | MODEL               | CC                      | YEAR        | NOTES     | COLOR   | CODE          | PRICE   |
|------------------|---------------------|-------------------------|-------------|-----------|---------|---------------|---------|
|                  | XC SPORT ATV        | 525                     | 2009 > 2012 | Fireproof | Neutral | R-FLTKTMSXF7  | € 27,95 |
|                  |                     |                         |             |           | Neutral | R-FLTKTMSXF07 | € 24,95 |
|                  | LC4 RACING          | 400                     | 2001 > 2008 | Fireproof | Neutral | R-FLTKTMI4T00 | € 27,95 |
|                  |                     |                         |             | 3 Holes   | Neutral | R-FLTKTMI4T00 | € 24,95 |
|                  | LC4 SUPRMOTO        | 625                     | 2007        | Fireproof | Neutral | R-FLTKTMI4T00 | € 27,95 |
|                  |                     |                         |             | 3 Holes   | Neutral | R-FLTKTMI4T00 | € 24,95 |
|                  | SMR                 | 450                     | 2004 > 2006 | Fireproof | Neutral | R-FLTKTMI4T00 | € 27,95 |
|                  |                     |                         |             | 3 Holes   | Neutral | R-FLTKTMI4T00 | € 24,95 |
|                  | SMR                 | 525                     | 2004 > 2005 | Fireproof | Neutral | R-FLTKTMI4T00 | € 27,95 |
|                  |                     |                         |             | 3 Holes   | Neutral | R-FLTKTMI4T00 | € 24,95 |
|                  | SMR                 | 560                     | 2006 > 2007 | Fireproof | Neutral | R-FLTKTMI4T00 | € 27,95 |
|                  |                     |                         |             | 3 Holes   | Neutral | R-FLTKTMI4T00 | € 24,95 |
|                  | DUKE                | 520                     | 1998 > 1999 | Fireproof | Neutral | R-FLTKTMI4T00 | € 27,95 |
|                  |                     |                         |             | 3 Holes   | Neutral | R-FLTKTMI4T00 | € 24,95 |
|                  | MXC                 | 380                     | 1998 > 2001 | Fireproof | Neutral | R-FLTKTMI4T00 | € 27,95 |
|                  |                     |                         |             | 3 Holes   | Neutral | R-FLTKTMI4T00 | € 24,95 |
|                  | MXC                 | 520                     | 1999 > 2002 | Fireproof | Neutral | R-FLTKTMI4T00 | € 27,95 |
|                  |                     |                         |             | 3 Holes   | Neutral | R-FLTKTMI4T00 | € 24,95 |
|                  | GS / EGS            | 360                     | 1998 > 2000 | Fireproof | Neutral | R-FLTKTMI4T00 | € 27,95 |
|                  |                     |                         |             | 3 Holes   | Neutral | R-FLTKTMI4T00 | € 24,95 |
| <b>HUSQVARNA</b> | CR / WR             | 125-250-300             | 1992 > 2013 |           | Neutral | R-FLTHSQ2T003 | € 24,95 |
|                  | TC                  | 65                      | 2017 > 2023 |           | Neutral | R-FLTKT65097  | € 24,95 |
|                  | TC                  | 85                      | 2014 > 2017 |           | Neutral | R-FLTKT00085  | € 24,95 |
|                  | TC                  | 85                      | 2018 > 2023 |           | Neutral | R-FLTKT01885  | € 24,95 |
|                  | TC / TE             | 570                     | 2000 > 2004 |           | Neutral | R-FLTHSQ4T004 | € 24,95 |
|                  | TC / TE             | 449-511                 | 2011 > 2013 |           | Neutral | R-FLTHSQ4T011 | € 24,95 |
|                  | TC / TE             | 250-310-450-510         | 2013        |           | Neutral | R-FLTHSQ2T003 | € 24,95 |
|                  | TC                  | 125                     | 2014-2015   |           | Neutral | R-FLTKTMSXF11 | € 24,95 |
|                  |                     |                         |             | Fireproof | Neutral | R-FLTKTMSXF1  | € 27,95 |
|                  | TC                  | 125                     | 2016 > 2022 |           | Neutral | R-FLTKTMSXF16 | € 24,95 |
|                  |                     |                         |             | Fireproof | Neutral | R-FLTKTMSXF6  | € 27,95 |
|                  | TC                  | 250                     | 2014 > 2016 |           | Neutral | R-FLTKTMSXF11 | € 24,95 |
|                  |                     |                         |             | Fireproof | Neutral | R-FLTKTMSXF1  | € 27,95 |
|                  | TC                  | 250                     | 2017 > 2022 |           | Neutral | R-FLTKTMSXF16 | € 24,95 |
|                  |                     |                         |             | Fireproof | Neutral | R-FLTKTMSXF6  | € 27,95 |
| <b>NEW</b>       | TC                  | 125-250                 | 2023        |           | Neutral | R-FLTKTMSXF3  | € 27,95 |
|                  |                     |                         |             | Fireproof | Neutral | R-FLTKTMSXF23 | € 24,95 |
|                  | FC                  | 250-350-450             | 2014-2015   |           | Neutral | R-FLTKTMSXF11 | € 24,95 |
|                  |                     |                         |             | Fireproof | Neutral | R-FLTKTMSXF1  | € 27,95 |
|                  | FC/FX               | 250-350-450             | 2016 > 2022 |           | Neutral | R-FLTKTMSXF16 | € 24,95 |
|                  |                     |                         |             | Fireproof | Neutral | R-FLTKTMSXF6  | € 27,95 |
| <b>NEW</b>       | FC                  | 250-350-450             | 2023        |           | Neutral | R-FLTKTMSXF3  | € 27,95 |
|                  |                     |                         |             | Fireproof | Neutral | R-FLTKTMSXF23 | € 24,95 |
|                  | FC Rockstar Edition | 250-450                 | 2022        |           | Neutral | R-FLTKTMSXF3  | € 27,95 |
|                  |                     |                         |             | Fireproof | Neutral | R-FLTKTMSXF23 | € 24,95 |
|                  | TE / FE             | 125-250-300-450-501     | 2014 > 2016 |           | Neutral | R-FLTKTMSXF11 | € 24,95 |
|                  |                     |                         |             | Fireproof | Neutral | R-FLTKTMSXF1  | € 27,95 |
|                  | TE / FE             | 125-150-250-300-450-501 | 2017 > 2023 |           | Neutral | R-FLTKTMSXF16 | € 24,95 |
|                  |                     |                         |             | Fireproof | Neutral | R-FLTKTMSXF6  | € 27,95 |
|                  | TX/FX               | 125 > 350               | 2017 > 2022 |           | Neutral | R-FLTKTMSXF16 | € 24,95 |
|                  |                     |                         |             | Fireproof | Neutral | R-FLTKTMSXF6  | € 27,95 |
| <b>NEW</b>       | TX / FX             | 300-350-450             | 2023        |           | Neutral | R-FLTKTMSXF3  | € 27,95 |
|                  |                     |                         |             | Fireproof | Neutral | R-FLTKTMSXF23 | € 24,95 |
| <b>NEW</b>       | FS                  | 450                     | 2023        |           | Neutral | R-FLTKTMSXF3  | € 27,95 |
|                  |                     |                         |             | Fireproof | Neutral | R-FLTKTMSXF23 | € 24,95 |
| <b>HUSABERG</b>  | FE / FC             | ALL MODELS              | 2000 > 2008 |           | Neutral | R-FLTHBG00000 | € 24,95 |
|                  | FE / TE / FC        | ALL MODELS              | 2009 > 2012 |           | Neutral | R-FLTHBG00009 | € 24,95 |
|                  | FE                  | 250 > 500               | 2013 > 2014 |           | Neutral | R-FLTKTMSXF11 | € 24,95 |
|                  |                     |                         |             | Fireproof | Neutral | R-FLTKTMSXF1  | € 27,95 |
|                  | TE                  | 125                     | 2012        |           | Neutral | R-FLTKTMSXF07 | € 24,95 |
|                  |                     |                         |             | Fireproof | Neutral | R-FLTKTMSXF7  | € 27,95 |
|                  | TE                  | 125                     | 2013-2014   |           | Neutral | R-FLTKTMSXF11 | € 24,95 |
|                  |                     |                         |             | Fireproof | Neutral | R-FLTKTMSXF1  | € 27,95 |
|                  | TE                  | 250-300                 | 2011-2012   |           | Neutral | R-FLTKTMSXF07 | € 24,95 |
|                  |                     |                         |             | Fireproof | Neutral | R-FLTKTMSXF7  | € 27,95 |
|                  | TE                  | 250-300                 | 2013-2014   |           | Neutral | R-FLTKTMSXF11 | € 24,95 |
|                  |                     |                         |             | Fireproof | Neutral | R-FLTKTMSXF1  | € 27,95 |
| <b>GAS-GAS</b>   | MC                  | 65                      | 2021 > 2023 |           | Neutral | R-FLTKT65097  | € 24,95 |
|                  | MC                  | 85                      | 2021 > 2023 |           | Neutral | R-FLTKT01885  | € 24,95 |
|                  | EC / MC / FSR       | 125 > 450               | 1998 > 2006 |           | Neutral | R-FLTX000002  | € 24,95 |
|                  | EC                  | 125 > 450               | 2007 > 2020 |           | Neutral | R-FLTGAS00007 | € 24,95 |
|                  | FSR / SM            | 125 > 450               | 2007 > 2015 |           | Neutral | R-FLTGAS00007 | € 24,95 |
|                  | MC                  | 125 > 450               | 2007 > 2015 |           | Neutral | R-FLTGAS00007 | € 24,95 |
|                  | MC/MC-F/EC/EC-F     | 125-250-300-350-450     | 2021 > 2023 |           | Neutral | R-FLTKTMSXF6  | € 24,95 |
|                  | EX / EX-F           |                         |             | Fireproof | Neutral | R-FLTKTMSXF16 | € 27,95 |
| <b>SHERCO</b>    | SE                  | 125-250-300             | 2014 > 2023 |           | Neutral | R-FLTSHE00014 | € 24,95 |
|                  | SEF                 | 250-300-450-500         | 2012 > 2023 |           | Neutral | R-FLTSHE00014 | € 24,95 |

## FUEL SYSTEM-ALIMENTAZIONE DOUBLE LAYER AIR FILTERS / FILTRI ARIA DOPPIO STRATO

| BRAND              | MODEL              | CC                 | YEAR        | NOTES     | COLOR                | CODE                 | PRICE   |
|--------------------|--------------------|--------------------|-------------|-----------|----------------------|----------------------|---------|
| TM                 | EN / MX / SM       | 85-125-144-250-300 | 2000 > 2021 |           | Neutral              | <b>R-FLTCR012502</b> | € 24,95 |
|                    | EN / MX / SM       | 125-144-250-300    | 2022-2023   |           | Neutral              | <b>R-FLTTM2T0022</b> | € 24,95 |
|                    | ENF / MXF / SMF    | 250 > 660          | 2000 > 2014 |           | Neutral              | <b>R-FLTCR012502</b> | € 24,95 |
| FANTIC             | ENF / MXF / SMF    | 250-450-530        | 2015 > 2023 |           | Neutral              | <b>R-FLTTM4T0015</b> | € 24,95 |
|                    | TS / TZ / TF / TR  | 125-250-300        | 2011 > 2015 |           | Neutral              | <b>R-FLTGAS00007</b> | € 24,95 |
|                    | XX / XE            | 125-250            | 2021 > 2022 |           | Neutral              | <b>R-FLTYZ125001</b> | € 24,95 |
|                    | <b>NEW</b> XX / XE | 125-250            | 2023        |           | Neutral              | <b>R-FLTKTMSXF16</b> | € 24,95 |
|                    |                    |                    |             | Fireproof | Neutral              | <b>R-FLTKTMISXF6</b> | € 27,95 |
|                    | XXF / XEF          | 250                | 2021 > 2023 |           | Neutral              | <b>R-FLTYZF45018</b> | € 24,95 |
|                    |                    |                    |             | Fireproof | Neutral              | <b>R-FLTYZF45I18</b> | € 27,95 |
|                    | XXF                | 450                | 2021-2022   |           | Neutral              | <b>R-FLTYZF45018</b> | € 24,95 |
|                    |                    |                    |             | Fireproof | Neutral              | <b>R-FLTYZF45I18</b> | € 27,95 |
|                    | <b>NEW</b> XXF     | 450                | 2023        |           | Neutral              | <b>R-FLTYZF45023</b> | € 24,95 |
|                    |                    |                    | Fireproof   | Neutral   | <b>R-FLTYZF45I23</b> | € 27,95              |         |
|                    | XEF                | 450                | 2021 > 2023 |           | Neutral              | <b>R-FLTYZF45018</b> | € 24,95 |
|                    |                    |                    |             | Fireproof | Neutral              | <b>R-FLTYZF45I18</b> | € 27,95 |
| BETA               | RR                 | 125 > 480          | 2020 > 2023 |           | Neutral              | <b>R-FLTBETRR020</b> | € 24,95 |
|                    | RR                 | 400-450-525        | 2005 > 2010 |           | Neutral              | <b>R-FLTBETRR012</b> | € 24,95 |
|                    | RR                 | 250                | 2013 > 2019 |           | Neutral              | <b>R-FLTBETRR016</b> | € 24,95 |
|                    | RR                 | 350                | 2014 > 2019 |           | Neutral              | <b>R-FLTBETRR016</b> | € 24,95 |
|                    | RR                 | 390-430-480        | 2015 > 2019 |           | Neutral              | <b>R-FLTBETRR016</b> | € 24,95 |
|                    | RR                 | 400-450-498        | 2013 > 2014 |           | Neutral              | <b>R-FLTBETRR016</b> | € 24,95 |
|                    | X-TRAINER          | 250                | 2018 > 2023 |           | Neutral              | <b>R-FLTBETRR016</b> | € 24,95 |
|                    | X-TRAINER          | 300                | 2015 > 2023 |           | Neutral              | <b>R-FLTBETRR016</b> | € 24,95 |
| ELASTIC AIR FILTER | SAND PROTECTION    |                    | Universal   |           | White                | <b>R-FLTSANDRT01</b> | € 26,95 |

## FUEL SYSTEM-ALIMENTAZIONE BIO WASH KIT



€ 109.95

### BIO WASH KIT

Racing super seal foam lame resistant bio filter oil  
Kit bio filtri aria 1lt olio + 5lt detergente  
**R-WASHKIT0002**



Super seal air filter cleaner 5 lt  
Detergente Bio pulizia filtri aria 5lt  
**CLEANER0011**

€ 59.95



Oil cleaner cage 1Lt  
Olio Racing Bio per filtro aria 1lt  
**OILFILTER11**

€ 27.95



Elastic air filter sand protection  
Rete filtrante antisabbia elastica  
**R-FLTSANDRT01**

€ 26.95

With ergonomic grip and 100% soft waterproof seal, integrated with the cover.

*Impugnatura ergonomica antiscivolo, guarnizione morbida 100% impermeabile, integrata nel coperchio.*



## AIRBOX COVERS WITH HERMETIC SOFT SEAL

- Keep dirt out of your Air Box during maintenance or air filter changes.
- Manufactured top quality utilizing polypropylene to provide a perfect fit and seal.
- Multi-component construction features - outer shell combined with a soft and flexible mating surface - 100% waterproof seal.

## COPERCHI CASSA FILTRO CON GUARNIZIONE ERMETICA

- Realizzati in polipropilene bicomponente di prima scelta con guarnizione 100% impermeabile.
- Sono dotati di una pratica impugnatura che ne consente il perfetto posizionamento in sede.

| BRAND         | MODEL           | CC          | YEAR        | COLOR       | CODE          | PRICE         |         |
|---------------|-----------------|-------------|-------------|-------------|---------------|---------------|---------|
| <b>HONDA</b>  | CR              | 125-250     | 2002 > 2007 | Red-Yellow  | R-CPKX00300BL | € 19,95       |         |
|               | CRF             | 250         | 2004 > 2009 | Red-Yellow  | R-CPKXF0011BL | € 19,95       |         |
|               | CRF             | 250         | 2010 > 2017 | Red-Yellow  | R-CPCRF0009BL | € 19,95       |         |
|               | CRF-R           | 250         | 2018 > 2021 | Red-Yellow  | R-CPCRF0017BL | € 19,95       |         |
|               | CRF-R / CRF-RX  | 250         | 2022-2023   | Red-Yellow  | R-CPCRF0021BL | € 19,95       |         |
|               | CRF-RX          | 250         | 2019 > 2021 | Red-Yellow  | R-CPCRF0017BL | € 19,95       |         |
|               | CRFX            | 250         | 2004 > 2019 | Red-Yellow  | R-CPKXF0011BL | € 19,95       |         |
|               | CRFX            | 450         | 2005 > 2017 | Red-Yellow  | R-CPKXF0011BL | € 19,95       |         |
|               | CRFX / CRF-L    | 450         | 2019 > 2023 | Red-Yellow  | R-CPCRF0017BL | € 19,95       |         |
|               | CRF             | 450         | 2003 > 2008 | Red-Yellow  | R-CPKXF0011BL | € 19,95       |         |
|               | CRF             | 450         | 2009 > 2016 | Red-Yellow  | R-CPCRF0009BL | € 19,95       |         |
|               | CRF-R / CRF-RX  | 450         | 2017 > 2020 | Red-Yellow  | R-CPCRF0017BL | € 19,95       |         |
|               | CRF / CRF-RWE   | 450         | 2021 > 2023 | Red-Yellow  | R-CPCRF0021BL | € 19,95       |         |
|               | CRF-RX          | 450         | 2021 > 2023 | Red-Yellow  | R-CPCRF0021BL | € 19,95       |         |
| <b>YAMAHA</b> | YZ / YZ-X       | 125-250     | 1997 > 2023 | Red-Yellow  | R-CPYZF9603BL | € 19,95       |         |
|               | YZF             | 400-426-450 | 1998 > 2009 | Red-Yellow  | R-CPYZF9603BL | € 19,95       |         |
|               | YZF             | 250         | 2001 > 2013 | Red-Yellow  | R-CPYZF9603BL | € 19,95       |         |
|               | YZF / YZ-FX     | 250         | 2014 > 2023 | Red-Yellow  | R-CPYZF0018BL | € 19,95       |         |
|               | YZF             | 450         | 2010 > 2013 | Red-Yellow  | R-CPYZF0010BL | € 19,95       |         |
|               | YZF             | 450         | 2014 > 2022 | Red-Yellow  | R-CPYZF0018BL | € 19,95       |         |
|               | YZF             | 450         | 2023        | Red-Yellow  | R-CPYZF0023BL | € 19,95       |         |
| <b>NEW</b>    | YZ-FX           | 450         | 2014 > 2023 | Red-Yellow  | R-CPYZF0018BL | € 19,95       |         |
|               | WRF             | 250         | 2015 > 2023 | Red-Yellow  | R-CPYZF0018BL | € 19,95       |         |
|               | WRF             | 450         | 2016 > 2023 | Red-Yellow  | R-CPYZF0018BL | € 19,95       |         |
|               | <b>KAWASAKI</b> | KX          | 125-250     | 1994 > 2008 | Red-Yellow    | R-CPKX00300BL | € 19,95 |
|               |                 | KXF         | 250         | 2004 > 2016 | Red-Yellow    | R-CPKXF0011BL | € 19,95 |
|               |                 | KXF         | 250         | 2017 > 2020 | Red-Yellow    | R-CPKXF0016BL | € 19,95 |
|               |                 | KXF         | 250         | 2021 > 2023 | Red-Yellow    | R-CPKXF0019BL | € 19,95 |
| KX-XC         |                 | 250-450     | 2021 > 2023 | Red-Yellow  | R-CPKXF0019BL | € 19,95       |         |
| KXF           |                 | 450         | 2004 > 2015 | Red-Yellow  | R-CPKXF0011BL | € 19,95       |         |
| KXF           |                 | 450         | 2016 > 2018 | Red-Yellow  | R-CPKXF0016BL | € 19,95       |         |
| <b>SUZUKI</b> | KXF             | 450         | 2019 > 2023 | Red-Yellow  | R-CPKXF0019BL | € 19,95       |         |
|               | RM              | 125         | 2004 > 2011 | Red-Yellow  | R-CPYZF9603BL | € 19,95       |         |
|               | RM              | 250         | 2003 > 2011 | Red-Yellow  | R-CPYZF9603BL | € 19,95       |         |
|               | RMZ             | 250         | 2007 > 2018 | Red-Yellow  | R-CPYZF9603BL | € 19,95       |         |
|               | RMZ             | 250         | 2019 > 2023 | Red-Yellow  | R-CPRMZ0018BL | € 19,95       |         |
|               | RMZ             | 450         | 2005 > 2017 | Red-Yellow  | R-CPYZF9603BL | € 19,95       |         |
|               | RMZ             | 450         | 2018 > 2023 | Red-Yellow  | R-CPRMZ0018BL | € 19,95       |         |

| BRAND            | MODEL                   | CC                  | YEAR        | COLOR       | CODE          | PRICE        |         |
|------------------|-------------------------|---------------------|-------------|-------------|---------------|--------------|---------|
| <b>KTM</b>       | SX                      | 85                  | 2005 > 2012 | Red-Yellow  | R-CPKTM011BL  | € 19,95      |         |
|                  | SX                      | 85                  | 2018 > 2023 | Red-Yellow  | R-CPKTM0018BL | € 19,95      |         |
|                  | SX                      | 105                 | 2006 > 2010 | Red-Yellow  | R-CPKTM011BL  | € 19,95      |         |
|                  | SX                      | 125                 | 2003 > 2010 | Red-Yellow  | R-CPKTM011BL  | € 19,95      |         |
|                  | SX                      | 125-150             | 2016 > 2022 | Red-Yellow  | R-CPKTM016BL  | € 19,95      |         |
|                  | <b>NEW</b>              | SX                  | 125-250-300 | 2023        | Red-Yellow    | R-CPKTM023BL | € 19,95 |
|                  | SX                      | 144                 | 2007 > 2008 | Red-Yellow  | R-CPKTM011BL  | € 19,95      |         |
|                  | SX                      | 150                 | 2009 > 2010 | Red-Yellow  | R-CPKTM011BL  | € 19,95      |         |
|                  | SX                      | 200                 | 2003 > 2004 | Red-Yellow  | R-CPKTM011BL  | € 19,95      |         |
|                  | SX                      | 250                 | 2003 > 2010 | Red-Yellow  | R-CPKTM011BL  | € 19,95      |         |
|                  | SX                      | 520                 | 1999 > 2002 | Red-Yellow  | R-CPKTM011BL  | € 19,95      |         |
|                  | SX                      | 525                 | 2003 > 2006 | Red-Yellow  | R-CPKTM011BL  | € 19,95      |         |
|                  | SXF                     | 250                 | 2005 > 2010 | Red-Yellow  | R-CPKTM011BL  | € 19,95      |         |
|                  | SXF                     | 450                 | 2003 > 2010 | Red-Yellow  | R-CPKTM011BL  | € 19,95      |         |
|                  | <b>NEW</b>              | SXF / XC-F          | 250-350-450 | 2016 > 2022 | Red-Yellow    | R-CPKTM016BL | € 19,95 |
| <b>NEW</b>       | SXF                     | 250-350-450         | 2023        | Red-Yellow  | R-CPKTM023BL  | € 19,95      |         |
|                  | SXF Factory Edition     | 250-450             | 2022        | Red-Yellow  | R-CPKTM023BL  | € 19,95      |         |
|                  | SXF                     | 505                 | 2007 > 2009 | Red-Yellow  | R-CPKTM011BL  | € 19,95      |         |
|                  | SXC                     | 540                 | 2000 > 2004 | Red-Yellow  | R-CPKTM011BL  | € 19,95      |         |
|                  | EXC                     | 125                 | 2004 > 2011 | Red-Yellow  | R-CPKTM011BL  | € 19,95      |         |
|                  | EXC                     | 200                 | 2002 > 2011 | Red-Yellow  | R-CPKTM011BL  | € 19,95      |         |
|                  | EXC Racing              | 250                 | 2001 > 2006 | Red-Yellow  | R-CPKTM011BL  | € 19,95      |         |
|                  | EXC                     | 300                 | 2004 > 2007 | Red-Yellow  | R-CPKTM011BL  | € 19,95      |         |
|                  | EXC                     | 250-300-450         | 2003 > 2011 | Red-Yellow  | R-CPKTM011BL  | € 19,95      |         |
|                  | EXC                     | 380                 | 1998 > 2002 | Red-Yellow  | R-CPKTM011BL  | € 19,95      |         |
|                  | EXCF                    | 250                 | 2007 > 2011 | Red-Yellow  | R-CPKTM011BL  | € 19,95      |         |
|                  | EXC                     | 400-530             | 2008 > 2011 | Red-Yellow  | R-CPKTM011BL  | € 19,95      |         |
|                  | EXC / EXCF              | 250-300-350-450-500 | 2017 > 2023 | Red-Yellow  | R-CPKTM016BL  | € 19,95      |         |
|                  | EXC                     | 520                 | 2001-2002   | Red-Yellow  | R-CPKTM011BL  | € 19,95      |         |
|                  | XC                      | 105                 | 2008 > 2009 | Red-Yellow  | R-CPKTM011BL  | € 19,95      |         |
|                  | XC-W                    | 125-150             | 2017 > 2023 | Red-Yellow  | R-CPKTM016BL  | € 19,95      |         |
|                  | XC                      | 150                 | 2010        | Red-Yellow  | R-CPKTM011BL  | € 19,95      |         |
| <b>NEW</b>       | XC / XCF                | 125-250-300-350-450 | 2023        | Red-Yellow  | R-CPKTM023BL  | € 19,95      |         |
|                  | LC4 Racing              | 400                 | 2001 > 2008 | Red-Yellow  | R-CPKTM011BL  | € 19,95      |         |
|                  | LC4 Supermoto           | 625                 | 2007        | Red-Yellow  | R-CPKTM011BL  | € 19,95      |         |
|                  | SMR                     | 450                 | 2004 > 2006 | Red-Yellow  | R-CPKTM011BL  | € 19,95      |         |
|                  | SMR                     | 525                 | 2004 > 2005 | Red-Yellow  | R-CPKTM011BL  | € 19,95      |         |
|                  | SMR                     | 560                 | 2006 > 2007 | Red-Yellow  | R-CPKTM011BL  | € 19,95      |         |
|                  | MXC                     | 520                 | 1999 > 2002 | Red-Yellow  | R-CPKTM011BL  | € 19,95      |         |
|                  | DUKE                    | 520                 | 1998-1999   | Red-Yellow  | R-CPKTM011BL  | € 19,95      |         |
|                  | XC Sport ATV            | 450                 | 2008 > 2009 | Red-Yellow  | R-CPKTM011BL  | € 19,95      |         |
|                  | XC Sport ATV            | 525                 | 2009 > 2012 | Red-Yellow  | R-CPKTM011BL  | € 19,95      |         |
| <b>GAS GAS</b>   | MC                      | 85                  | 2021 > 2023 | Red-Yellow  | R-CPKTM0018BL | € 19,95      |         |
|                  | MC/MC-F/EC/EC-F/EX/EX-F | 125-250-300-350-450 | 2021 > 2023 | Red-Yellow  | R-CPKTM016BL  | € 19,95      |         |
| <b>HUSQVARNA</b> | TC                      | 85                  | 2018 > 2023 | Red-Yellow  | R-CPKTM0018BL | € 19,95      |         |
|                  | TC                      | 125                 | 2016 > 2022 | Red-Yellow  | R-CPKTM016BL  | € 19,95      |         |
| <b>NEW</b>       | TC                      | 125-250             | 2023        | Red-Yellow  | R-CPKTM023BL  | € 19,95      |         |
| <b>NEW</b>       | FC                      | 250-350-450         | 2016 > 2022 | Red-Yellow  | R-CPKTM016BL  | € 19,95      |         |
| <b>NEW</b>       | FC                      | 250-350-450         | 2023        | Red-Yellow  | R-CPKTM023BL  | € 19,95      |         |
|                  | FC Rockstar             | 250-450             | 2022        | Red-Yellow  | R-CPKTM023BL  | € 19,95      |         |
|                  | TE / FE                 | 125-250-300-450-501 | 2017 > 2023 | Red-Yellow  | R-CPKTM016BL  | € 19,95      |         |
|                  | TX                      | 125-150             | 2017 > 2023 | Red-Yellow  | R-CPKTM016BL  | € 19,95      |         |
|                  | TX / FX                 | 250-300-350-450     | 2017 > 2022 | Red-Yellow  | R-CPKTM016BL  | € 19,95      |         |
| <b>NEW</b>       | TX / FX                 | 250-350-450         | 2023        | Red-Yellow  | R-CPKTM023BL  | € 19,95      |         |
| <b>NEW</b>       | FS                      | 450                 | 2023        | Red-Yellow  | R-CPKTM023BL  | € 19,95      |         |
| <b>BETA</b>      | RR                      | 125 > 480           | 2020 > 2023 | Red-Yellow  | R-CPBETA020BL | € 19,95      |         |
| <b>FANTIC</b>    | XX / XE                 | 125-250             | 2021-2022   | Red-Yellow  | R-CPYZF9603BL | € 19,95      |         |
| <b>NEW</b>       | XX / XE                 | 125-250             | 2023        | Red-Yellow  | R-CPKTM016BL  | € 19,95      |         |
|                  | XXF / XEF               | 250                 | 2021 > 2023 | Red-Yellow  | R-CPYZF0018BL | € 19,95      |         |
|                  | XXF                     | 450                 | 2021-2022   | Red-Yellow  | R-CPYZF0018BL | € 19,95      |         |
| <b>NEW</b>       | XXF                     | 450                 | 2023        | Red-Yellow  | R-CPYZF0023BL | € 19,95      |         |
|                  | XEF                     | 450                 | 2021 > 2023 | Red-Yellow  | R-CPYZF0018BL | € 19,95      |         |

## FUEL SYSTEM-ALIMENTAZIONE ANTI-SLOSH FUEL TANK FOAM / SPUGNA RETICOLATA

Anti-Slosh fuel tank foam  
Spugna reticolata a cubetti  
R-FOAMASLG10

€ 29.95



### ANTI-SLOSH FUEL TANK FOAM

Eliminate the sloshing into the fuel tank (volume 2,6 lt), it takes just 1% of the original volume inside the fuel tank.

### SPUGNA RETICOLATA A CUBETTI

Elimina il nocivo sbattimento della benzina all'interno del serbatoio. Il contenuto della confezione occupa un volume di 2,6 lt, con una perdita della capacità di solo l' 1%.



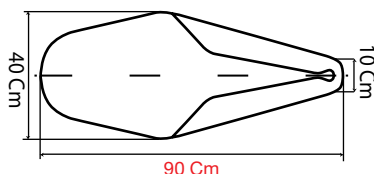

**EXTRA LONG** seat cover with logo  
Copertina sella **EXTRA LONG** con logo  
**R-CSUNIVNR017**

€ 36.95

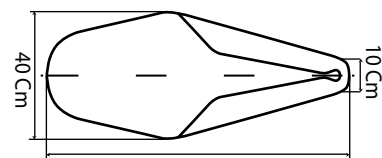

**UNIVERSAL** seat cover with logo  
Copertina sella **UNIVERSALE** con logo  
**R-CSUNIVNR005**

€ 36.95



Universal step with adhesive  
Step per spugna sella con adesivo  
**R-STEPFOAM001**

€ 18.95



Seat foams standard height  
Spugne sella Altezza standard  
**R-SPUYZF10014**

€ 49.95



Universal pocket for cover  
Taschino portatabella per copertina sella  
**R-TASKUNIV005**

€ 17.95

## SEAT FOAMS

Seat foams with a greater density than originals, they assure a longer duration than the standard one. Available also with the increased height of 15 mm.

## SPUGNA SELLA

Spugne sella di densità superiore alle originali, garantiscono una più elevata durata nel tempo rispetto alle selle standard. Disponibili anche in versione rialzata di +15 mm.

| BRAND | MODEL           | CC  | YEAR        | NOTES           | COLOR   | CODE                 | PRICE   |
|-------|-----------------|-----|-------------|-----------------|---------|----------------------|---------|
| HONDA | CRF             | 150 | 2007 > 2023 | Standard height | Neutral | <b>R-SPUCRF00150</b> | € 49,95 |
|       | CRF             | 250 | 2010 > 2013 | Height + 15 mm  | Neutral | <b>R-SPUCRF00009</b> | € 49,95 |
|       |                 |     |             | Standard height | Neutral | <b>R-SPUCRF10009</b> |         |
|       | CRF             | 250 | 2014 > 2017 | Height + 15 mm  | Neutral | <b>R-SPUCRF00013</b> | € 49,95 |
|       |                 |     |             | Standard height | Neutral | <b>R-SPUCRF10013</b> |         |
|       | CRF             | 250 | 2018 > 2021 | Height + 15 mm  | Neutral | <b>R-SPUCRF00017</b> | € 49,95 |
|       |                 |     |             | Standard height | Neutral | <b>R-SPUCRF10017</b> |         |
|       | CRF             | 250 | 2022-2023   | Height + 15 mm  | Neutral | <b>R-SPUCRFH0021</b> | € 49,95 |
|       |                 |     |             | Standard height | Neutral | <b>R-SPUCRF10021</b> |         |
|       | CRF-RX          | 250 | 2019 > 2021 | Height + 15 mm  | Neutral | <b>R-SPUCRF00017</b> | € 49,95 |
|       |                 |     |             | Standard height | Neutral | <b>R-SPUCRF10017</b> |         |
|       | CRF-RX          | 250 | 2022-2023   | Height + 15 mm  | Neutral | <b>R-SPUCRFH0021</b> | € 49,95 |
|       |                 |     |             | Standard height | Neutral | <b>R-SPUCRF10021</b> |         |
|       | CRF             | 450 | 2009 > 2012 | Height + 15 mm  | Neutral | <b>R-SPUCRF00009</b> | € 49,95 |
|       |                 |     |             | Standard height | Neutral | <b>R-SPUCRF10009</b> |         |
|       | CRF             | 450 | 2013 > 2016 | Height + 15 mm  | Neutral | <b>R-SPUCRF00013</b> | € 49,95 |
|       |                 |     |             | Standard height | Neutral | <b>R-SPUCRF10013</b> |         |
|       | CRF-R / CRF-RWE | 450 | 2021-2022   | Height + 15 mm  | Neutral | <b>R-SPUCRF10021</b> | € 49,95 |
|       |                 |     |             | Standard height | Neutral | <b>R-SPUCRFH0021</b> |         |
|       | CRF-R / CRF-RX  | 450 | 2017 > 2020 | Height + 15 mm  | Neutral | <b>R-SPUCRF00017</b> | € 49,95 |
|       |                 |     |             | Standard height | Neutral | <b>R-SPUCRF10017</b> |         |
|       | CRFX            | 450 | 2019 > 2021 | Height + 15 mm  | Neutral | <b>R-SPUCRF00017</b> | € 49,95 |
|       |                 |     |             | Standard height | Neutral | <b>R-SPUCRF10017</b> |         |
|       | CRF-RX          | 450 | 2021 > 2023 | Height + 15 mm  | Neutral | <b>R-SPUCRFH0021</b> | € 49,95 |
|       |                 |     |             | Standard height | Neutral | <b>R-SPUCRF10021</b> |         |

## FUEL SYSTEM-ALIMENTAZIONE SEAT COVER – SEAT FOAMS / COPERTINA E SPUGNE SELLA

| BRAND           | MODEL               | CC                  | YEAR            | NOTES           | COLOR         | CODE           | PRICE   |
|-----------------|---------------------|---------------------|-----------------|-----------------|---------------|----------------|---------|
| <b>YAMAHA</b>   | YZ                  | 85                  | 2002 > 2021     | Standard height | Neutral       | R-SPUYZ000085  | € 49,95 |
|                 | YZ                  | 85                  | 2022 > 2023     | Standard height | Neutral       | R-SPUYZ002285  | € 49,95 |
|                 | YZ                  | 125-250             | 2002 > 2021     | Height + 15 mm  | Neutral       | R-SPUYZ0H0203  | € 49,95 |
|                 |                     |                     |                 | Standard height | Neutral       | R-SPUYZ000203  |         |
|                 | YZ                  | 125-250             | 2022-2023       | Height + 15 mm  | Neutral       | R-SPUYZ0H0022  | € 49,95 |
|                 |                     |                     |                 | Standard height | Neutral       | R-SPUYZ010022  |         |
|                 | YZ-X                | 125-250             | 2016 > 2021     | Height + 15 mm  | Neutral       | R-SPUYZ0H0203  | € 49,95 |
|                 |                     |                     |                 | Standard height | Neutral       | R-SPUYZ000203  |         |
|                 | YZF                 | 250                 | 2010 > 2013     | Height + 15 mm  | Neutral       | R-SPUYZF02510  | € 49,95 |
|                 |                     |                     |                 | Standard height | Neutral       | R-SPUYZF12510  |         |
|                 | YZF                 | 450                 | 2010 > 2013     | Height + 15 mm  | Neutral       | R-SPUYZF04510  | € 49,95 |
|                 |                     |                     |                 | Standard height | Neutral       | R-SPUYZF14510  |         |
|                 | YZF                 | 250                 | 2014 > 2018     | Height + 15 mm  | Neutral       | R-SPUYZF00014  | € 49,95 |
|                 |                     |                     |                 | Standard height | Neutral       | R-SPUYZF10014  |         |
|                 | YZF                 | 250                 | 2019 > 2023     | Height + 15 mm  | Neutral       | R-SPUYZF00018  | € 49,95 |
|                 |                     |                     |                 | Standard height | Neutral       | R-SPUYZF10018  |         |
|                 | YZF                 | 450                 | 2014 > 2017     | Height + 15 mm  | Neutral       | R-SPUYZF00014  | € 49,95 |
|                 |                     |                     |                 | Standard height | Neutral       | R-SPUYZF10014  |         |
|                 | YZF                 | 450                 | 2018 > 2022     | Height + 15 mm  | Neutral       | R-SPUYZF00018  | € 49,95 |
|                 |                     |                     |                 | Standard height | Neutral       | R-SPUYZF10018  |         |
| YZF             | 450                 | 2023                | Height + 15 mm  | Neutral         | R-SPUYZF00023 | € 49,95        |         |
|                 |                     |                     | Standard height | Neutral         | R-SPUYZF10023 |                |         |
| YZ-FX           | 250                 | 2020 > 2023         | Height + 15 mm  | Neutral         | R-SPUYZF00018 | € 49,95        |         |
|                 |                     |                     | Standard height | Neutral         | R-SPUYZF10018 |                |         |
| YZ-FX           | 450                 | 2019 > 2023         | Height + 15 mm  | Neutral         | R-SPUYZF00018 | € 49,95        |         |
|                 |                     |                     | Standard height | Neutral         | R-SPUYZF10018 |                |         |
| WRF             | 250                 | 2020 > 2023         | Height + 15 mm  | Neutral         | R-SPUYZF00018 | € 49,95        |         |
|                 |                     |                     | Standard height | Neutral         | R-SPUYZF10018 |                |         |
| WRF             | 450                 | 2019 > 2023         | Height + 15 mm  | Neutral         | R-SPUYZF00018 | € 49,95        |         |
|                 |                     |                     | Standard height | Neutral         | R-SPUYZF10018 |                |         |
| <b>KAWASAKI</b> | KXF                 | 85                  | 2014 > 2023     | Standard height | Neutral       | R-SPUKXF001485 | € 49,95 |
|                 | KXF                 | 250                 | 2009 > 2012     | Height + 15 mm  | Neutral       | R-SPUKXF00009  | € 49,95 |
|                 | KXF                 | 250                 | 2013 > 2016     | Height + 15 mm  | Neutral       | R-SPUKXF00012  | € 49,95 |
|                 |                     |                     |                 | Standard height | Neutral       | R-SPUKXF10012  |         |
|                 | KXF                 | 250                 | 2017 > 2020     | Height + 15 mm  | Neutral       | R-SPUKXF00017  | € 49,95 |
|                 |                     |                     |                 | Standard height | Neutral       | R-SPUKXF10017  |         |
|                 | KXF                 | 250                 | 2021 > 2023     | Height + 15 mm  | Neutral       | R-SPUKXF00019  | € 49,95 |
|                 |                     |                     |                 | Standard height | Neutral       | R-SPUKXF10019  |         |
|                 | KXF                 | 450                 | 2009 > 2011     | Height + 15 mm  | Neutral       | R-SPUKXF00009  | € 49,95 |
|                 | KXF                 | 450                 | 2012 > 2015     | Height + 15 mm  | Neutral       | R-SPUKXF00012  | € 49,95 |
|                 |                     |                     |                 | Standard height | Neutral       | R-SPUKXF10012  |         |
|                 | KXF                 | 450                 | 2016 > 2018     | Height + 15 mm  | Neutral       | R-SPUKXF00016  | € 49,95 |
|                 |                     |                     |                 | Standard height | Neutral       | R-SPUKXF10016  |         |
|                 | KXF                 | 450                 | 2019 > 2023     | Height + 15 mm  | Neutral       | R-SPUKXF00019  | € 49,95 |
|                 |                     |                     |                 | Standard height | Neutral       | R-SPUKXF10019  |         |
| KX-XC           | 250-450             | 2021 > 2023         | Height + 15 mm  | Neutral         | R-SPUKXF00019 | € 49,95        |         |
|                 |                     |                     | Standard height | Neutral         | R-SPUKXF10019 |                |         |
| <b>SUZUKI</b>   | RMZ                 | 250                 | 2010 > 2018     | Height + 15 mm  | Neutral       | R-SPURMZ00010  | € 49,95 |
|                 |                     |                     |                 | Standard height | Neutral       | R-SPURMZ10010  |         |
|                 | RMZ                 | 250                 | 2019 > 2023     | Height + 15 mm  | Neutral       | R-SPURMZ00018  | € 49,95 |
|                 |                     |                     |                 | Standard height | Neutral       | R-SPURMZ10018  |         |
|                 | RMZ                 | 450                 | 2008 > 2017     | Height + 15 mm  | Neutral       | R-SPURMZ00008  | € 49,95 |
|                 |                     |                     | Standard height | Neutral         | R-SPURMZ10008 |                |         |
| RMZ             | 450                 | 2018 > 2023         | Height + 15 mm  | Neutral         | R-SPURMZ00018 | € 49,95        |         |
|                 |                     |                     | Standard height | Neutral         | R-SPURMZ10018 |                |         |
| <b>KTM</b>      | SX                  | 125-144-150-250     | 2007 > 2010     | Height + 15 mm  | Neutral       | R-SPUKTM00007  | € 49,95 |
|                 |                     |                     |                 | Standard height | Neutral       | R-SPUKTM10007  |         |
|                 | SX                  | 125-150             | 2011 > 2015     | Height + 15 mm  | Neutral       | R-SPUKTM00011  | € 49,95 |
|                 |                     |                     |                 | Standard height | Neutral       | R-SPUKTM10011  |         |
|                 | SX/SXF/XC-F         | 125-150-250-350-450 | 2016 > 2018     | Height + 15 mm  | Neutral       | R-SPUKTMH0016  | € 49,95 |
|                 |                     |                     |                 | Standard height | Neutral       | R-SPUKTM10016  |         |
|                 | SX / XC             | 125-150-250-300     | 2019 > 2022     | Height + 15 mm  | Neutral       | R-SPUKTMH0019  | € 49,95 |
|                 |                     |                     |                 | Standard height | Neutral       | R-SPUKTM10019  |         |
|                 | SX                  | 125-250-300         | 2023            | Height + 15 mm  | Neutral       | R-SPUKTMH0023  | € 49,95 |
|                 |                     |                     |                 | Standard height | Neutral       | R-SPUKTM10023  |         |
|                 | XC / XC-F           | 125-250-300-350-450 | 2023            | Height + 15 mm  | Neutral       | R-SPUKTMH0023  | € 49,95 |
|                 |                     |                     |                 | Standard height | Neutral       | R-SPUKTM10023  |         |
|                 | SX                  | 250                 | 2011 > 2016     | Height + 15 mm  | Neutral       | R-SPUKTM00011  | € 49,95 |
|                 |                     |                     |                 | Standard height | Neutral       | R-SPUKTM10011  |         |
|                 | SX                  | 250                 | 2017-2018       | Height + 15 mm  | Neutral       | R-SPUKTMH0016  | € 49,95 |
|                 |                     |                     | Standard height | Neutral         | R-SPUKTM10016 |                |         |
| SXF             | 250-450-505         | 2007 > 2010         | Height + 15 mm  | Neutral         | R-SPUKTM00007 | € 49,95        |         |
|                 |                     |                     | Standard height | Neutral         | R-SPUKTM10007 |                |         |
| SXF             | 250-350-450         | 2011 > 2015         | Height + 15 mm  | Neutral         | R-SPUKTM00011 | € 49,95        |         |
|                 |                     |                     | Standard height | Neutral         | R-SPUKTM10011 |                |         |
| SXF             | 450 FACTORY EDITION | 2018                | Height + 15 mm  | Neutral         | R-SPUKTMH0019 | € 49,95        |         |
|                 |                     |                     | Standard height | Neutral         | R-SPUKTM10019 |                |         |
| SXF / XC-F      | 250-350-450         | 2019 > 2022         | Height + 15 mm  | Neutral         | R-SPUKTMH0019 | € 49,95        |         |
|                 |                     |                     | Standard height | Neutral         | R-SPUKTM10019 |                |         |
| SXF             | 250-350-450         | 2023                | Height + 15 mm  | Neutral         | R-SPUKTMH0023 | € 49,95        |         |
|                 |                     |                     | Standard height | Neutral         | R-SPUKTM10023 |                |         |

# FUEL SYSTEM-ALIMENTAZIONE SEAT COVER – SEAT FOAMS / COPERTINA E SPUGNE SELLA

| BRAND            | MODEL                      | CC                       | YEAR        | NOTES                             | COLOR   | CODE                           | PRICE   |
|------------------|----------------------------|--------------------------|-------------|-----------------------------------|---------|--------------------------------|---------|
|                  | SXF                        | 250-450 FACTORY EDITION  | 2022-2023   | Height + 15 mm<br>Standard height | Neutral | R-SPUKTMH0023<br>R-SPUKTM10023 | € 49,95 |
|                  | EXC / EXCF                 | 125 > 530                | 2008 > 2011 | Height + 15 mm<br>Standard height | Neutral | R-SPUKTM00007<br>R-SPUKTM10007 | € 49,95 |
|                  | EXC / EXCF                 | 125 > 530                | 2012 > 2016 | Height + 15 mm<br>Standard height | Neutral | R-SPUKTM00011<br>R-SPUKTM10011 | € 49,95 |
|                  | EXC / EXCF                 | 250-350-450-500          | 2017-2019   | Height + 15 mm<br>Standard height | Neutral | R-SPUKTMH0016<br>R-SPUKTM10016 | € 49,95 |
|                  | XC-W                       | 125-150                  | 2017-2019   | Height + 15 mm<br>Standard height | Neutral | R-SPUKTMH0016<br>R-SPUKTM10016 | € 49,95 |
|                  | EXC / EXCF<br>XC-W / XCF-W | 250-300-350-450-500      | 2020 > 2023 | Standard height<br>Height + 15 mm | Neutral | R-SPUKTM10019<br>R-SPUKTMH0019 | € 49,95 |
| <b>HUSQVARNA</b> | TE / FE                    | 125 > 501                | 2014 > 2016 | Height + 15 mm<br>Standard height | Neutral | R-SPUHSQ00014<br>R-SPUHSQ10014 | € 49,95 |
|                  | TE / FE                    | 125 > 501                | 2017 > 2019 | Height + 15 mm<br>Standard height | Neutral | R-SPUHSQH0016<br>R-SPUHSQ10016 | € 49,95 |
|                  | TE / FE                    | 125 > 501                | 2020 > 2023 | Height + 15 mm<br>Standard height | Neutral | R-SPUHSQH0019<br>R-SPUHSQ10019 | € 49,95 |
|                  | TX                         | 125                      | 2017 > 2019 | Height + 15 mm<br>Standard height | Neutral | R-SPUHSQH0016<br>R-SPUHSQ10016 | € 49,95 |
|                  | TX                         | 300                      | 2017 > 2018 | Height + 15 mm<br>Standard height | Neutral | R-SPUHSQH0016<br>R-SPUHSQ10016 | € 49,95 |
|                  | TX                         | 300                      | 2019 > 2022 | Height + 15 mm<br>Standard height | Neutral | R-SPUHSQH0019<br>R-SPUHSQ10019 | € 49,95 |
|                  | TC                         | 125                      | 2014-2015   | Height + 15 mm<br>Standard height | Neutral | R-SPUHSQ00014<br>R-SPUHSQ10014 | € 49,95 |
|                  | TC                         | 125                      | 2016 > 2018 | Height + 15 mm<br>Standard height | Neutral | R-SPUHSQH0016<br>R-SPUHSQ10016 | € 49,95 |
|                  | TC                         | 250                      | 2014 > 2016 | Height + 15 mm<br>Standard height | Neutral | R-SPUHSQ00014<br>R-SPUHSQ10014 | € 49,95 |
|                  | TC                         | 250                      | 2017-2018   | Height + 15 mm<br>Standard height | Neutral | R-SPUHSQH0016<br>R-SPUHSQ10016 | € 49,95 |
|                  | TC                         | 125-250                  | 2019 > 2022 | Height + 15 mm<br>Standard height | Neutral | R-SPUHSQH0019<br>R-SPUHSQ10019 | € 49,95 |
|                  | FC                         | 250-350-450              | 2014-2015   | Height + 15 mm<br>Standard height | Neutral | R-SPUHSQ00014<br>R-SPUHSQ10014 | € 49,95 |
|                  | FC/FX                      | 250-350-450              | 2016 > 2018 | Height + 15 mm<br>Standard height | Neutral | R-SPUHSQH0016<br>R-SPUHSQ10016 | € 49,95 |
|                  | FC/FS/FX                   | 250-350-450              | 2019 > 2022 | Height + 15 mm<br>Standard height | Neutral | R-SPUHSQH0019<br>R-SPUHSQ10019 | € 49,95 |
|                  | FC                         | 450 ROCKSTAR EDITION     | 2018 > 2022 | Height + 15 mm<br>Standard height | Neutral | R-SPUHSQH0019<br>R-SPUHSQ10019 | € 49,95 |
|                  | TC / FC                    | 125-250-300-350-450      | 2023        | Height + 15 mm<br>Standard height | Neutral | R-SPUHSQH0023<br>R-SPUHSQ10023 | € 49,95 |
|                  | FC                         | 250-450 ROCKSTAR EDITION | 2022        | Height + 15 mm<br>Standard height | Neutral | R-SPUHSQH0023<br>R-SPUHSQ10023 | € 49,95 |
|                  | TX / FX                    | 300-350-450              | 2023        | Height + 15 mm<br>Standard height | Neutral | R-SPUHSQH0023<br>R-SPUHSQ10023 | € 49,95 |
|                  | FS                         | 450                      | 2023        | Height + 15 mm<br>Standard height | Neutral | R-SPUHSQH0023<br>R-SPUHSQ10023 | € 49,95 |
| <b>HUSABERG</b>  | TE / FE                    | 125 > 501                | 2013-2014   | Height + 15 mm<br>Standard height | Neutral | R-SPUHSQ00014<br>R-SPUHSQ10014 | € 49,95 |
| <b>GAS GAS</b>   | EC/EC-F                    | 250-300-350              | 2021 > 2023 | Height + 15 mm<br>Standard height | Neutral | R-SPUKTMH0019<br>R-SPUKTM10019 | € 49,95 |
|                  | MC/MC-F/<br>EX/EX-F        | 125-250-300-350-450      | 2021 > 2023 | Height + 15 mm<br>Standard height | Neutral | R-SPUKTMH0019<br>R-SPUKTM10019 | € 49,95 |
| <b>BETA</b>      | RR                         | 125 > 530                | 2020 > 2023 | Height + 15 mm<br>Standard height | Neutral | R-SPUBETH0020<br>R-SPUBET10020 | € 49,95 |
| <b>SHERCO</b>    | SE                         | 250-300                  | 2014 > 2016 | Height + 15 mm<br>Standard height | Neutral | R-SPUSHEH0015<br>R-SPUSHE10015 | € 49,95 |
|                  | SEF                        | 250-300-450              | 2012 > 2016 | Height + 15 mm<br>Standard height | Neutral | R-SPUSHEH0015<br>R-SPUSHE10015 | € 49,95 |
| <b>FANTIC</b>    | XXF / XEF                  | 250                      | 2021 > 2023 | Height + 15 mm<br>Standard height | Neutral | R-SPUYZFH0018<br>R-SPUYZF10018 | € 49,95 |
|                  | XXF                        | 450                      | 2021 > 2022 | Height + 15 mm<br>Standard height | Neutral | R-SPUYZFH0018<br>R-SPUYZF10018 | € 49,95 |
|                  | XXF                        | 450                      | 2023        | Height + 15 mm<br>Standard height | Neutral | R-SPUYZFH0023<br>R-SPUYZF10023 | € 49,95 |
|                  | XEF                        | 450                      | 2021 > 2023 | Height + 15 mm<br>Standard height | Neutral | R-SPUYZFH0018<br>R-SPUYZF10018 | € 49,95 |
| <b>UNIVERSAL</b> | -                          | -                        | -           | Universal step with adhesive      | Neutral | R-STEPFOAM001                  | € 18,95 |





## HANDLEBARS

ø 22 mm [7/8" ] handlebars >pag 292

ø 22 mm [7/8" ] minicross handlebars >pag 293

ø 22 mm [7/8" ] ATV/Quad handlebars >pag 293

ø 28,6 mm [1-1/8" ] handlebars >pag 294

ø 28,6 mm [7/8" ] tapered handlebars >pag 296

ø 28,6 mm [7/8" ] atv tapered handlebars >pag 297

Crossbar pad >pag 297

ø 22 > 28 mm handlebars adapter >pag 298

Handlebars riser >pag 298

## THE BEST RESISTANCE, SUPPLENESS AND LIGHTNESS

Available just in 7075 t6 ergal. Total symmetry in the size of the grooves and accurate blocking of the cross brace thanks to the CNC machined rings, micrometric fixing thanks to lasered graduated reference.

## IL MASSIMO DELLA RESISTENZA, ELASTICITÀ E LEGGEREZZA.

Prodotti esclusivamente in ergal 7075 t6 con trattamento termico per rispettare il giusto grado di flessibilità.

Simmetria assoluta nella misura delle pieghe e preciso bloccaggio del traversino grazie ai collarini lavorati a CNC.



€ 69.95

Handlebar / Manubrio  
Damon B. Ø22mm (7/8")  
**R-MNDB0T10022 - titanium color**



Handlebar / Manubrio  
David K. Ø22 mm (7/8")  
**R-MNDK0NR0022 - black color**

| DESCRIPTION                               | COLOR    | CODE                 | PRICE   |
|---|----------|----------------------|---------|
| Handlebar DAMON B. Ø22 bar pad included   | Black    | <b>R-MNDB0NR0022</b> | € 69,95 |
|   | Titanium | <b>R-MNDB0T10022</b> |         |
| Handlebar DAVID K. Ø22 bar pad included   | Black    | <b>R-MNDK0NR0022</b> | € 69,95 |
|   | Titanium | <b>R-MNDK0T10022</b> |         |
| Handlebar MICHAEL P. Ø22 bar pad included | Black    | <b>R-MNMP0NR0022</b> | € 69,95 |
|   | Titanium | <b>R-MNMP0T10022</b> |         |
| Handlebar PIT B. Ø22 bar pad included     | Black    | <b>R-MNPB0NR0022</b> | € 69,95 |
|   | Red      | <b>R-MNPB0RS0022</b> |         |
|   | Titanium | <b>R-MNPB0T10022</b> |         |

| BEND LIST         |     |     |    |     |    |                   |
|-------------------|-----|-----|----|-----|----|-------------------|
|                   | A   | B   | C  | D   | E  | Piegia/Bend       |
| <b>PIT B.</b>     | 800 | 118 | 75 | 132 | 44 | Supercross (High) |
| <b>MICHAEL P.</b> | 810 | 80  | 63 | 135 | 44 | Medium            |
| <b>DAMON B.</b>   | 808 | 115 | 80 | 135 | 54 | Crf High          |
| <b>DAVID K.</b>   | 803 | 97  | 64 | 140 | 51 | *Ktm*             |



Micrometric fixing thanks to lasered graduated reference.  
Fissaggio micrometrico grazie alle tacche di riferimento graduate

## HANDLEBARS-MANUBRI Ø 22 MM [7/8" ] MINICROSS HANDLEBARS - MANUBRI MINICROSS



Handlebar replica bend KTM SX 85 mini Ø22 mm (7/8")  
 Manubrio replica piega ktm sx 85 mini Ø 22 con paracolpi  
**R-MNSXJNR0022 - black color**

€ 69.95

### BAR PAD INCLUDED / PARACOLPI INCLUSO



Handlebar Pit B. mini Ø22 mm (7/8")  
 Manubrio pit b. Mini Ø 22 con paracolpi  
**R-MNPBJT10022 - titanium color**

| DESCRIPTION                                    | COLOR    | CODE                 | PRICE   |
|--|----------|----------------------|---------|
| Handlebar PIT B. mini Ø22 mm (7/8")            | Black    | <b>R-MNPBJNR0022</b> | € 69,95 |
|  | Titanium | <b>R-MNPBJT10022</b> |         |
| Handlebar replica KTM SX 85 mini Ø22 mm (7/8") | Black    | <b>R-MNSXJNR0022</b> | € 69,95 |
| Handlebar RICKY C. Ø22 mm (7/8")               | Black    | <b>R-MNRCJNR0022</b> | € 69,95 |

| BEND LIST |     |     |     |     |    |                         |
|-----------|-----|-----|-----|-----|----|-------------------------|
|           | A   | B   | C   | D   | E  | Piega/Bend              |
| PIT B.    | 750 | 154 | 108 | 120 | 60 |                         |
| RICKY C.  | 730 | 110 | 90  | 110 | 75 |                         |
| SX 85     | 775 | 90  | 61  | 130 | 70 | Piega replica KTM Sx 85 |

## HANDLEBARS-MANUBRI Ø 22 MM [7/8" ] ATV-QUAD HANDLEBARS / MANUBRI ATV-QUAD



### BAR PAD INCLUDED / PARACOLPI INCLUSO

ATV Ø 22 mm (7/8") handlebars  
 Manubrio piega atv Ø 22 con paracolpi  
**R-MNATVNR0022 - black color**

€ 69.95

| BEND LIST |     |     |     |     |     |                |
|-----------|-----|-----|-----|-----|-----|----------------|
|           | A   | B   | C   | D   | E   | Piega/Bend     |
| ATV D.22  | 800 | 155 | 110 | 165 | 100 | Piega Atv alta |

## HANDLEBARS-MANUBRI Ø 28,6 MM [1-1/8" ] HANDLEBARS - MANUBRI

Please specify when ordering the color of desired bar pad (see on page 225 the range of colors)  
If the color of the bar pad will not be specified at the moment of the order the handlebar will be delivered with standard black bar pad.

*\* Specificare al momento dell'ordine del manubrio il colore del paracolpi desiderato (vedere a pag. 225 i colori disponibili).  
Se non specificato il manubrio verrà consegnato con paracolpi standard di colore nero.*



**BAR PAD INCLUDED  
PARACOLPI INCLUSO**

**€ 99.95**

Handlebar PIT B. Ø28,6 mm (1-1/8") \* - Red  
Manubrio pit b. Ø 28,6 con paracolpi \* - Rosso  
**R-MNPBORS0028 - Red color**



**BAR PAD INCLUDED  
PARACOLPI INCLUSO**

**€ 99.95**

Handlebar MICHAEL P. Ø28,6 mm (1-1/8") \*  
Manubrio michael p. Ø28,6 con paracolpi \*  
**R-MNMPOTI0028 - Titanium color**



**BAR PAD INCLUDED  
PARACOLPI INCLUSO**

**€ 99.95**

Handlebar DAMON B. Ø28,6 mm (1-1/8") \*  
Manubrio damon b. Ø28,6 con paracolpi \*  
**R-MNDBONR0028 - Black color**

CHOOSE YOUR  
BAR PADS COLOR \*



**BAR PAD INCLUDED  
PARACOLPI INCLUSO**

Manubrio david k. Ø28,6 (1-1/8") con paracolpi \*  
Manubrio david k. Ø28,6 con paracolpi \*  
**R-MNDK0AR0028 - color Orange**

**€ 99.95**

## BEND LIST

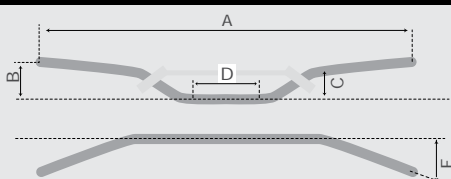

|                   | A   | B   | C  | D   | E  | Bend              |
|-------------------|-----|-----|----|-----|----|-------------------|
| <b>PIT B.</b>     | 800 | 118 | 75 | 132 | 44 | Supercross (High) |
| <b>MICHAEL P.</b> | 810 | 80  | 63 | 135 | 44 | Medium            |
| <b>DAMON B.</b>   | 808 | 115 | 80 | 135 | 54 | Crf High          |
| <b>DAVID K.</b>   | 803 | 97  | 64 | 140 | 51 | "Ktm"             |

| DESCRIPTION                          | COLOR    | CODE                 | PRICE   |
|--------------------------------------|----------|----------------------|---------|
| Handlebar DAMON B. Ø28 mm (1-1/8")   | Black    | <b>R-MNDB0NR0028</b> | € 99,95 |
|                                      | Titanium | <b>R-MNDB0TI0028</b> |         |
| Handlebar DAVID K. Ø28 mm (1-1/8")   | Orange   | <b>R-MNDK0AR0028</b> | € 99,95 |
|                                      | Black    | <b>R-MNDK0NR0028</b> |         |
|                                      | Titanium | <b>R-MNDK0TI0028</b> |         |
| Handlebar MICHAEL P. Ø28 mm (1-1/8") | Black    | <b>R-MNMP0NR0028</b> | € 99,95 |
|                                      | Titanium | <b>R-MNMP0TI0028</b> |         |
|                                      | Blue     | <b>R-MNMP0BL0028</b> |         |
| Handlebar PIT B. Ø28 mm (1-1/8")     | Black    | <b>R-MNPB0NR0028</b> | € 99,95 |
|                                      | Red      | <b>R-MNPB0RS0028</b> |         |
|                                      | Titanium | <b>R-MNPB0TI0028</b> |         |

Please specify when ordering the color of desired bar pad (see on page 297 the range of colors)

If the color of the bar pad will not be specified at the moment of the order the handlebar will be delivered with standard black bar pad.

\* Specificare al momento dell'ordine del manubrio il colore del paracolpi desiderato (vedere a pag. 297 i colori disponibili).

Se non specificato il manubrio verrà consegnato con paracolpi standard di colore nero.





**BAR PAD INCLUDED  
PARACOLPI INCLUSO**

**€ 119.95**

Handlebar MICHAEL P. Ø28,6 mm (1-1/8") - Black  
Manubrio michael p. Ø28,6 con traversino e paracolpi - Nero  
**R-MNMPONR0R28**



**BAR PAD INCLUDED  
PARACOLPI INCLUSO**

**€ 119.95**

Handlebar DAVID K. Ø28 mm (1-1/8")  
Manubrio david k. Ø28 con traversino e paracolpi  
**R-MNDK0T10R28**  
Titanium color



**BAR PAD INCLUDED  
PARACOLPI INCLUSO**

**€ 119.95**

Handlebar DAVID K. Ø28 mm (1-1/8") - Orange  
Manubrio david k. Ø28 con traversino e paracolpi - Arancione  
**R-MNDK0AR0R28**

| DESCRIPTION                          | COLOR    | CODE                 | PRICE    |
|--------------------------------------|----------|----------------------|----------|
| Handlebar DAMON B. Ø28 mm (1-1/8")   | Black    | <b>R-MNDB0NR0R28</b> | € 119,95 |
|                                      | Titanium | <b>R-MNDB0T10R28</b> |          |
| Handlebar DAVID K. Ø28 mm (1-1/8")   | Orange   | <b>R-MNDK0AR0R28</b> | € 119,95 |
|                                      | Black    | <b>R-MNDK0NR0R28</b> |          |
| Handlebar MICHAEL P. Ø28 mm (1-1/8") | Titanium | <b>R-MNDK0T10R28</b> | € 119,95 |
|                                      | Black    | <b>R-MNMP0NR0R28</b> |          |
|                                      | Titanium | <b>R-MNMP0T10R28</b> |          |
| Handlebar PIT B. Ø28 mm (1-1/8")     | Blue     | <b>R-MNMP0BL0R28</b> | € 119,95 |
|                                      | Black    | <b>R-MNPB0NR0R28</b> |          |
|                                      | Red      | <b>R-MNPB0RS0R28</b> |          |
|                                      | Titanium | <b>R-MNPB0T10R28</b> |          |

| BEND LIST  |     |     |    |     |    |                   |
|------------|-----|-----|----|-----|----|-------------------|
|            | A   | B   | C  | D   | E  | Bend              |
| PIT B.     | 800 | 118 | 75 | 132 | 44 | Supercross (High) |
| MICHAEL P. | 810 | 80  | 63 | 135 | 44 | Medium            |
| DAMON B.   | 808 | 115 | 80 | 135 | 54 | Crf High          |
| DAVID K.   | 803 | 97  | 64 | 140 | 51 | "Ktm"             |

# HANDLEBARS-MANUBRI Ø 28,6 MM [1-1/8" ] ATV TAPERED HANDLEBARS MANUBRI ATV SEZIONE VARIABILE



**BAR PAD INCLUDED  
PARACOLPI INCLUSO**

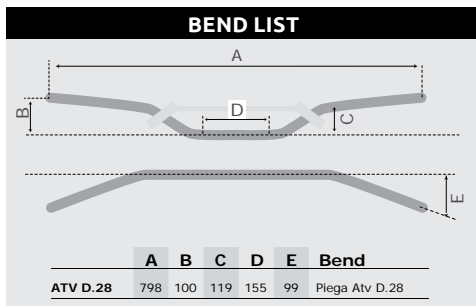

ATV Ø28 mm (1-1/8") handlebar \* - Black  
Manubrio piega atv ø 28 con paracolpi \* - Nero  
**R-MNATVNR0028**

**€ 99.95**

Please specify when ordering the color of desired bar pad (see on page 297 the range of colors)  
If the color of the bar pad will not be specified at the moment of the order the handlebar will be delivered with standard black bar pad.

*\* Specificare al momento dell'ordine del manubrio il colore del paracolpi desiderato ( vedere a pag. 297 i colori disponibili).  
Se non specificato il manubrio verrà consegnato con paracolpi standard di colore nero.*

## HANDLEBARS-MANUBRI CROSSBAR PAD / PARACOLPI

Crossbar pad L 300 mm  
Paracolpi tubolare 300 mm  
**R-PCMNBNR0022**

**€ 19.95**



Ø28 mm (1-1/8") rubber handlebar bar pad  
Paracolpi manubrio ø28 in gomma  
**R-PCMNBNR0125**

Minicross crossbar pad L 260 mm  
Paracolpi tubolare minicross 260 mm  
**R-PCMNBNR0122**

**€ 19.95**



**€ 19.95**



Neon Orange  
**R-PCMNBAN0018**



Blue  
**R-PCMNBBL0018**

**€ 24.95**



Black  
**R-PCMNBNR0018**



Red  
**R-PCMNBRF0018**



Neon Yellow  
**R-PCMNBGF0018**



Green  
**R-PCMNBEV0018**



## HANDLEBARS-MANUBRI Ø 22 > 28 MM HANDLEBARS ADAPTERS / ADATTATORI MANUBRIO



Available in three different versions with high from the center of the handlebar to the bottom part of the adapter of +15, +25, +35mm

Disponibile in tre differenti versioni con altezze dal centro manubrio a base di appoggio di +15, +25 o +35mm.

| DESCRIPTION  | COLOR | CODE                 | PRICE   |
|--|-------|----------------------|---------|
| Bar mounts Ø22 > Ø28 con viti H+15 MM- screws included | Black | <b>R-COLLONR0028</b> | € 64,95 |
| Bar mounts Ø22 > Ø28 H+25 MM- screws included          | Black | <b>R-COLLONR1028</b> | € 64,95 |
| Bar mounts Ø22 > Ø28 H+35 MM- screws included          | Black | <b>R-COLLONR2028</b> | € 64,95 |

## HANDLEBARS-MANUBRI Ø 22 HANDLEBARS RISER / RIALZI MANUBRIO



| DESCRIPTION                           | COLOR  | CODE                 | PRICE   |
|---------------------------------------|--------|----------------------|---------|
| Risers kit Ø22+10mm - screws included | Silver | <b>R-KITRIAL1022</b> | € 32,95 |
| Risers kit Ø22+20mm - screws included | Silver | <b>R-KITRIAL2022</b> | € 32,95 |

## HANDLEBARS-MANUBRI Ø 28 HANDLEBARS RISER / RIALZI MANUBRIO



| DESCRIPTION                           | COLOR  | CODE                 | PRICE   |
|---------------------------------------|--------|----------------------|---------|
| Risers kit Ø28+10mm - screws included | Silver | <b>R-KITRIAL1028</b> | € 32,95 |
| Risers kit Ø28+20mm - screws included | Silver | <b>R-KITRIAL2028</b> | € 32,95 |







## **CONTROLS**

*Unbreakable breake levers >pag 302*

*Unbreakable clutch levers >pag 304*

*Unbreakable clutch cable levers >pag 304*

*Aluminum trottle tube >pag 305*

*CNC Brake pedal >pag 307*

*Shift lever >pag 308*

*Lift control >pag 310*

*Fork bleeder >pag 311*

*Gas tank valve >pag 311*

*Special steel screws >pag 311*

**STRONG FORGED LEVERS**

Complete with rubber protection, unbreakable cnc machined, they assure the best reliability in case of fall.

**ROBUSTE LEVE FORGIATE**

Complete di protezione in gomma, snodate, rifinite a CNC, garantiscono la massima affidabilità in caso di caduta.

| BRAND    | MODEL             | CC            | YEAR        | NOTE  | COLOR         | CODE          | PRICE   |
|----------|-------------------|---------------|-------------|-------|---------------|---------------|---------|
| HONDA    | CR                | 80-85         | 1992 > 2007 |       | Red           | R-LEV11041BRS | € 48,95 |
|          |                   |               |             |       | Black         | R-LEV11041BNR |         |
|          | CR / CRF          | 125 > 450     | 1992 > 2006 |       | Black         | R-LEV11041BNR | € 48,95 |
|          |                   |               |             |       | Red           | R-LEV11041BRS |         |
|          | CR / CRF / CRF-RX | 125 > 450     | 2007 > 2023 |       | Black         | R-LEV11051BNR | € 48,95 |
|          |                   |               |             |       | Red           | R-LEV11051BRS |         |
|          | CRF               | 150           | 2007 > 2022 |       | Black         | R-LEV11041BNR | € 48,95 |
|          |                   |               |             | Red   | R-LEV11041BRS |               |         |
|          | XR                | 250-400       | 1995 > 2009 |       | Black         | R-LEV11041BNR | € 48,95 |
|          |                   |               |             |       | Red           | R-LEV11041BRS |         |
|          | XR                | 650           | 2000 > 2009 |       | Black         | R-LEV11041BNR | € 48,95 |
|          |                   |               |             |       | Red           | R-LEV11041BRS |         |
| YAMAHA   | YZ                | 80-85-125-250 | 2001 > 2007 |       | Blue          | R-LEV31061BBL | € 48,95 |
|          |                   |               |             |       | Red           | R-LEV31061BRS |         |
|          |                   |               |             |       | Black         | R-LEV31061FNR |         |
|          | YZ                | 125-250       | 2008 > 2023 |       | Blue          | R-LEV41061BBL | € 48,95 |
|          |                   |               |             |       | Black         | R-LEV41061BNR |         |
|          | YZ-X              | 125-250       | 2016 > 2023 |       | Blue          | R-LEV41061BBL | € 48,95 |
|          |                   |               |             |       | Black         | R-LEV41061BNR |         |
|          | YZF               | 250           | 2001 > 2006 |       | Blue          | R-LEV31061BBL | € 48,95 |
|          |                   |               |             |       | Red           | R-LEV31061BRS |         |
|          |                   |               |             |       | Black         | R-LEV31061FNR |         |
|          | YZF               | 400-426-450   | 2001 > 2007 |       | Blue          | R-LEV31061BBL | € 48,95 |
|          |                   |               |             |       | Red           | R-LEV31061BRS |         |
|          |                   |               |             |       | Black         | R-LEV31061FNR |         |
|          | YZF               | 250           | 2007 > 2023 |       | Blue          | R-LEV41061BBL | € 48,95 |
|          |                   |               |             | Black | R-LEV41061BNR |               |         |
| YZF      | 450               | 2008 > 2023   |             | Blue  | R-LEV41061BBL | € 48,95       |         |
|          |                   |               |             | Black | R-LEV41061BNR |               |         |
| WRF      | 250               | 2015-2016     |             | Red   | R-LEV31061BRS | € 48,95       |         |
|          |                   |               |             | Blue  | R-LEV31061BBL |               |         |
|          |                   |               |             | Black | R-LEV31061FNR |               |         |
| WRF      | 250               | 2017 > 2023   |             | Blue  | R-LEV41061BBL | € 48,95       |         |
|          |                   |               |             | Black | R-LEV41061BNR |               |         |
| WRF      | 450               | 2016 > 2023   |             | Blue  | R-LEV41061BBL | € 48,95       |         |
|          |                   |               |             | Black | R-LEV41061BNR |               |         |
| KAWASAKI | KX                | 125-250-500   | 1993 > 1996 |       | Black         | R-LEV11041BNR | € 48,95 |
|          |                   |               |             |       | Red           | R-LEV11041BRS |         |
|          | KX                | 60 > 125      | 2000 > 2023 |       | Blue          | R-LEV31061BBL | € 48,95 |
|          |                   |               |             |       | Red           | R-LEV31061BRS |         |
|          |                   |               |             |       | Black         | R-LEV31061FNR |         |
|          | KXF               | 250-450       | 2004 > 2012 |       | Blue          | R-LEV31061BBL | € 48,95 |
|          |                   |               |             |       | Red           | R-LEV31061BRS |         |
|          |                   |               |             |       | Black         | R-LEV31061FNR |         |
|          | KXF               | 250           | 2013 > 2020 |       | Black         | R-LEV31063FNR | € 48,95 |
|          | KXF               | 250           | 2021 > 2023 |       | Black         | R-LEV31064FNR | € 48,95 |
|          | KXF               | 450           | 2013 > 2018 |       | Black         | R-LEV31063FNR | € 48,95 |
| KXF      | 450               | 2019 > 2023   |             | Black | R-LEV31064FNR | € 48,95       |         |
| KX-XC    | 250-450           | 2021 > 2023   |             | Black | R-LEV31064FNR | € 48,95       |         |
| SUZUKI   | RM                | 65            | 2003 > 2006 |       | Blue          | R-LEV31061BBL | € 48,95 |
|          |                   |               |             |       | Red           | R-LEV31061BRS |         |
|          |                   |               |             |       | Black         | R-LEV31061FNR |         |
|          | RM / RMZ          | 85 > 450      | 2004 > 2023 |       | Blue          | R-LEV31061BBL | € 48,95 |
|          |                   |               |             |       | Red           | R-LEV31061BRS |         |
|          |                   |               |             |       | Black         | R-LEV31061FNR |         |
| RM       | 125-250           | 1996 > 2003   |             | Black | R-LEV11041BNR | € 48,95       |         |
|          |                   |               |             | Red   | R-LEV11041BRS |               |         |



**R-LEV41061BBL**

**€ 48.95**



**R-LEV11041BNR**

**€ 48.95**



**R-LEV51054BAR**

**€ 48.95**

| BRAND           | MODEL             | CC          | YEAR        | NOTE         | COLOR                | CODE                 | PRICE   |
|-----------------|-------------------|-------------|-------------|--------------|----------------------|----------------------|---------|
| <b>KTM</b>      | SX                | 65-85       | 2013 > 2023 | FORMULA pump | Orange               | <b>R-LEV51085BAR</b> | € 48,95 |
|                 | SX / SXF          | 125 > 650   | 2000 > 2013 | BREMBO pump  | Black                | <b>R-LEV51051BNR</b> | € 48,95 |
|                 | EXC / EXCF        |             |             |              | Orange               | <b>R-LEV51051BAR</b> |         |
|                 | SX / SXF          | 125 > 500   | 2014 > 2023 | BREMBO pump  | Black                | <b>R-LEV51054BNR</b> | € 48,95 |
|                 |                   |             |             |              | Orange               | <b>R-LEV51054BAR</b> |         |
|                 | EXC / EXCF / XC-W | 125 > 500   | 2014 > 2023 | BREMBO pump  | Black                | <b>R-LEV51054BNR</b> | € 48,95 |
|                 |                   |             |             |              | Orange               | <b>R-LEV51054BAR</b> |         |
| <b>HUSABERG</b> | FREERIDE          | 250-350     | 2012 > 2023 | FORMULA pump | Orange               | <b>R-LEV51085BAR</b> | € 48,95 |
|                 | FC / FE / FS / TE | 125 > 570   | 2001 > 2014 | BREMBO pump  | Black                | <b>R-LEV51051BNR</b> | € 48,95 |
|                 | CR / WR / TC / TE | 125 > 510   | 2000 > 2013 | BREMBO pump  | Black                | <b>R-LEV51051BNR</b> | € 48,95 |
|                 | TC / FC / TX / FX | 125 > 510   | 2014 > 2023 | BREMBO pump  | Black                | <b>R-LEV51054BNR</b> | € 48,95 |
|                 | TE / FE           | 125 > 510   | 2014 > 2018 | BREMBO pump  | Black                | <b>R-LEV51054BNR</b> | € 48,95 |
|                 | TE / FE           | 125 > 510   | 2022-2023   | BRATEC pump  | Black                | <b>R-LEV51021GNR</b> | € 48,95 |
|                 |                   |             |             | Blue         | <b>R-LEV51021GBL</b> |                      |         |
| <b>GAS-GAS</b>  | EC / MC / FSR     | 125 > 450   | 2000 > 2020 | NISSIN pump  | Black                | <b>R-LEV11041BNR</b> | € 48,95 |
|                 |                   |             |             |              | Red                  | <b>R-LEV11041BRS</b> |         |
|                 | MC / MCF          | 125-250-450 | 2021 > 2023 | BREMBO pump  | Black                | <b>R-LEV51054BNR</b> | € 48,95 |
|                 |                   |             |             | Red          | <b>R-LEV51054BRS</b> |                      |         |
|                 | EC / ECF          | 250-300-350 | 2021 > 2023 | BRAKTEK pump | Black                | <b>R-LEV51021GNR</b> | € 48,95 |
|                 |                   |             |             |              | Red                  | <b>R-LEV51021GRS</b> |         |
| <b>BETA</b>     | RR                | 250 > 525   | 2005 > 2023 | NISSIN pump  | Black                | <b>R-LEV11041BNR</b> | € 48,95 |
|                 |                   |             |             |              | Red                  | <b>R-LEV11041BRS</b> |         |
| <b>FANTIC</b>   | TF / TZ           | 125-250-300 | 2011 > 2015 | NISSIN pump  | Black                | <b>R-LEV11041BNR</b> | € 48,95 |
|                 |                   |             |             |              | Red                  | <b>R-LEV11041BRS</b> |         |
|                 | XX / XE           | 125-250     | 2021 > 2023 | NISSIN pump  | Black                | <b>R-LEV41061BNR</b> | € 48,95 |
|                 | XXF / XEF         | 250-450     | 2021 > 2023 | NISSIN pump  | Black                | <b>R-LEV41061BNR</b> | € 48,95 |
| <b>TM</b>       | EN / MX           | 125 > 500   | 2007 > 2023 | NISSIN pump  | Black                | <b>R-LEV11041BNR</b> | € 48,95 |
|                 |                   |             |             |              | Red                  | <b>R-LEV11041BRS</b> |         |

## CONTROLS-COMANDI UNBREAKABLE CLUTCH LEVERS / LEVE FRIZIONE ANTIROTTURA



R-LEV51072CNR

€ 48.95



R-LEV51082XAR



R-LEV51062CNR

| BRAND     | MODEL                   | CC          | YEAR        | NOTE                                       | COLOR  | CODE                           | PRICE   |
|-----------|-------------------------|-------------|-------------|--|--------|--------------------------------|---------|
| HONDA     | CRF-R/CRF-RWE<br>CRF-RX | 450         | 2021 > 2023 | NISSIN pump                                | Black  | R-LEV71022XNR<br>R-LEV71022XRS | € 48,95 |
| KAWASAKI  | KXF                     | 250         | 2021 > 2023 | NISSIN pump                                | Black  | R-LEV71019XNR                  | € 48,95 |
|           | KXF                     | 450         | 2019 > 2023 | NISSIN pump                                | Black  | R-LEV71019XNR                  | € 48,95 |
|           | KX-XC                   | 250-450     | 2021 > 2023 | NISSIN pump                                | Black  | R-LEV71019XNR                  | € 48,95 |
| KTM       | SX / SXF                | 85 > 650    | 2000 > 2023 | BREMBO pump                                | Orange | R-LEV51072CAR                  | € 48,95 |
|           | XC-W / XC-F             |             |             |  | Black  | R-LEV51072CNR                  |         |
|           | SX / SXF                | 85 > 650    | 2003 > 2023 | MAGURA HYMEC SERIE 163 pump (RED register) | Orange | R-LEV51062CAR                  | € 48,95 |
|           | XC-W / XC-F             |             |             |  | Black  | R-LEV51062CNR                  |         |
|           | SX / SXF                | 85 > 650    | 2009 > 2023 | MAGURA HYMEC SERIE 167 pump (Jointed)      | Orange | R-LEV51082XAR                  | € 48,95 |
|           | XC-W / XC-F             |             |             |  | Black  | R-LEV51082XNR                  |         |
|           | EXC / EXCF              | 85 > 650    | 2000 > 2023 | BREMBO pump                                | Orange | R-LEV51072CAR                  | € 48,95 |
|           |                         |             |             |  | Black  | R-LEV51072CNR                  |         |
|           | EXC / EXCF              | 85 > 650    | 2003 > 2023 | MAGURA HYMEC SERIE 163 pump (RED register) | Orange | R-LEV51062CAR                  | € 48,95 |
|           |                         |             |             |  | Black  | R-LEV51062CNR                  |         |
|           | EXC / EXCF              | 85 > 650    | 2009 > 2023 | MAGURA HYMEC SERIE 167 pump (Jointed)      | Orange | R-LEV51082XAR                  | € 48,95 |
|           |                         |             |             |  | Black  | R-LEV51082XNR                  |         |
| HUSABERG  | -                       | -           | -           | BREMBO pump                                | Black  | R-LEV51072CNR                  | € 48,95 |
|           |                         |             |             | MAGURA HYMEC SERIE 163 pump (RED register) | Black  | R-LEV51062CNR                  |         |
| HUSQVARNA | -                       | -           | -           | BREMBO pump                                | Black  | R-LEV51072CNR                  | € 48,95 |
|           |                         |             |             | MAGURA HYMEC SERIE 163 pump (RED register) | Black  | R-LEV51062CNR                  |         |
|           |                         |             |             | MAGURA HYMEC SERIE 167 pump (Jointed)      | Black  | R-LEV51082XNR                  |         |
|           | TE / FE                 | 150 > 501   | 2022-2023   | BRACTEC pump                               | Black  | R-LEV71021GNR                  | € 48,95 |
|           |                         |             |             |  | Blue   | R-LEV71021GBL                  |         |
| BETA      | RR                      | 250 > 530   | 2011 > 2023 | BREMBO pump                                | Black  | R-LEV51072CNR                  | € 48,95 |
| FANTIC    | TZ / TS                 | 85 > 650    | 2011 > 2015 | BREMBO pump                                | Black  | R-LEV51072CNR                  | € 48,95 |
| GAS GAS   | EC                      | 125-250-300 | 2013 > 2019 | MAGURA HYMEC SERIE 167 pump (Jointed)      | Black  | R-LEV51082XNR                  | € 48,95 |
|           | MC / MC-F               | 125-250-450 | 2021 > 2023 | BREMBO pump                                | Red    | R-LEV51072CRS                  | € 48,95 |
|           |                         |             |             |  | Black  | R-LEV51072CNR                  |         |
|           | EC / ECF                | 250-300-350 | 2021 > 2023 | BRACTEC pump                               | Red    | R-LEV71021GRS                  | € 48,95 |
|           |                         |             |             |  | Black  | R-LEV71021GNR                  |         |

## CONTROLS-COMANDI UNBREAKABLE CLUTCH CABLE LEVERS LEVE FRIZIONE ANTIROTTURA A CAVO

### STRONG FORGED CABLE LEVERS

Unbreakable cnc machined, complete with rapid adjuster, assure the best reliability in case of fall.

### ROBUSTE LEVE FORGIATE

Snodate, rifinite a cnc, dotate di registro rapido, garantiscono la massima affidabilità in caso di caduta.



R-LEV7315XCRS

€ 84.95



R-LEV7315XCBL



R-LEV7315XCNR

## CONTROLS-COMANDI BRAKE AND CLUTCH LEVERS REPLACEMENT PARTS RICAMBI LEVE FRENO E FRIZIONE



Short lever replacement brake or clutch  
*Ricambio leva corta freno e frizione*

**R-LEVREPBLO02**

**€ 23.95**



Short lever replacement brake or clutch  
*Ricambio leva corta freno e frizione*

**R-LEVREPNR002**



Short lever replacement brake or clutch  
*Ricambio leva corta freno e frizione*

**R-LEVREPAR002**



Short lever replacement brake or clutch  
*Ricambio leva corta freno e frizione*

**R-LEVREPRS002**



Long lever replacement brake or clutch  
*Ricambio leva lunga freno e frizione*

**R-LEVREPBLO01**

**€ 23.95**



Long lever replacement brake or clutch  
*Ricambio leva lunga freno e frizione*

**R-LEVREPNR001**



Rubber protection kit  
for clutch and brake lever  
*Kit protezioni in gomma  
leva freno e frizione*

**R-LEVREPKIT02**

**€ 8.95**



Forged lever replacement bearing  
*Kit cuscinetti leva freno e frizione*

**R-LEVREPKIT03**

**€ 12.95**

## CONTROLS-COMANDI ALUMINUM TROTTLER TUBE / COMANDO GAS

Aluminum trottle tube with bearing  
*Comando gas in alluminio con cuscinetto*



**€ 43.95**

**R-TUBOGASCRF0**

| BRAND | MODEL | CC      | YEAR        | COLOR  | CODE                 | PRICE   |
|-------|-------|---------|-------------|--------|----------------------|---------|
| HONDA | CRF   | 150     | 2007 > 2022 | Silver | <b>R-TUBOGASCRF0</b> | € 43,95 |
|       | CRF   | 250     | 2004 > 2023 | Silver | <b>R-TUBOGASCRF4</b> | € 43,95 |
|       | CRF   | 450     | 2002 > 2023 | Silver | <b>R-TUBOGASCRF4</b> | € 43,95 |
|       | CRFX  | 250-450 | 2005 > 2019 | Silver | <b>R-TUBOGASCRF4</b> | € 43,95 |



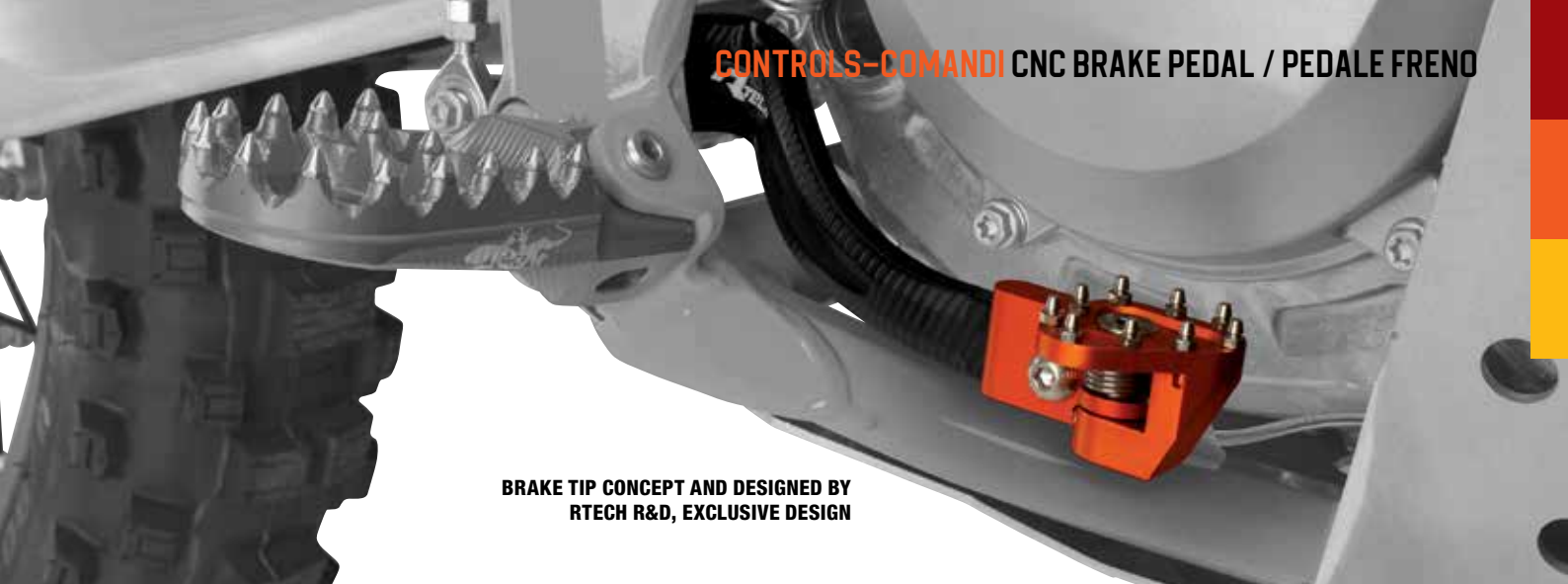

BRAKE TIP CONCEPT AND DESIGNED BY RTECH R&D, EXCLUSIVE DESIGN



R-LEVFRCRF003



R-LEVFRKTM0001

€ 89.95



R-LEVFRYZF0003

| BRAND     | MODEL        | CC                      | YEAR        | COLOR        | CODE           | PRICE   |
|-----------|--------------|-------------------------|-------------|--------------|----------------|---------|
| HONDA     | CRF          | 250                     | 2010 > 2023 | Black-Red    | R-LEVFRCRF0003 | € 89,95 |
|           | CRFX         | 250                     | 2004 > 2019 | Black-Red    | R-LEVFRCRF0004 | € 89,95 |
|           | CRF-RX       | 250                     | 2019 > 2023 | Black-Red    | R-LEVFRCRF0003 | € 89,95 |
|           | CRF          | 450                     | 2005 > 2008 | Black-Red    | R-LEVFRCRF0004 | € 89,95 |
|           | CRF-R/CRF-RX | 450                     | 2009 > 2023 | Black-Red    | R-LEVFRCRF0003 | € 89,95 |
|           | CRFX         | 450                     | 2005 > 2017 | Black-Red    | R-LEVFRCRF0004 | € 89,95 |
| YAMAHA    | CRFX/CRF-L   | 450                     | 2019 > 2023 | Black-Red    | R-LEVFRCRF0003 | € 89,95 |
|           | WRF          | 250                     | 2006 > 2013 | Black-Blue   | R-LEVFRYZF0001 | € 89,95 |
|           | WRF          | 250                     | 2015 > 2023 | Black-Blue   | R-LEVFRYZF0002 | € 89,95 |
|           | WRF          | 450                     | 2007 > 2011 | Black-Blue   | R-LEVFRYZF0001 | € 89,95 |
|           | WRF          | 450                     | 2012 > 2023 | Black-Blue   | R-LEVFRYZF0003 | € 89,95 |
|           | YZ           | 125-250                 | 2005 > 2023 | Black-Blue   | R-LEVFRYZF0001 | € 89,95 |
|           | YZ-X         | 125-250                 | 2016 > 2023 | Black-Blue   | R-LEVFRYZF0001 | € 89,95 |
|           | YZF          | 250                     | 2010 > 2018 | Black-Blue   | R-LEVFRYZF0002 | € 89,95 |
|           | YZF          | 250                     | 2019 > 2023 | Black-Blue   | R-LEVFRYZF0003 | € 89,95 |
|           | YZF          | 250-450                 | 2005 > 2009 | Black-Blue   | R-LEVFRYZF0001 | € 89,95 |
| KAWASAKI  | YZF          | 450                     | 2010 > 2023 | Black-Blue   | R-LEVFRYZF0003 | € 89,95 |
|           | KXF          | 250                     | 2005 > 2020 | Black-Red    | R-LEVFRKXF0001 | € 89,95 |
|           | KXF / KX-XC  | 250                     | 2021 > 2023 | Black-Red    | R-LEVFRKXF0002 | € 89,95 |
|           | KXF / KX-XC  | 450                     | 2006 > 2023 | Black-Red    | R-LEVFRKXF0002 | € 89,95 |
| SUZUKI    | RMZ          | 250                     | 2005 > 2006 | Black-Red    | R-LEVFRKXF0001 | € 89,95 |
|           | RMZ          | 250                     | 2007 > 2023 | Black-Red    | R-LEVFRRMZ0001 | € 89,95 |
|           | RMZ          | 450                     | 2005 > 2007 | Black-Red    | R-LEVFRRMZ0001 | € 89,95 |
| KTM       | EXC / EXCF   | 125 > 530               | 2000 > 2016 | Black-Orange | R-LEVFRKTM0001 | € 89,95 |
|           | EXC / EXCF   | 250-300-350-450-500     | 2017 > 2023 | Black-Orange | R-LEVFRKTM0002 | € 89,95 |
|           | SXF          | 250 > 530               | 2000 > 2015 | Black-Orange | R-LEVFRKTM0001 | € 89,95 |
|           | SXF / XC-F   | 250-350-450             | 2016 > 2023 | Black-Orange | R-LEVFRKTM0002 | € 89,95 |
|           | SX           | 125-144-150             | 2000 > 2015 | Black-Orange | R-LEVFRKTM0001 | € 89,95 |
|           | SX           | 125-150                 | 2016 > 2023 | Black-Orange | R-LEVFRKTM0002 | € 89,95 |
|           | SX           | 250                     | 2000 > 2016 | Black-Orange | R-LEVFRKTM0001 | € 89,95 |
|           | SX           | 250                     | 2017 > 2023 | Black-Orange | R-LEVFRKTM0002 | € 89,95 |
|           | XC-W         | 125-150                 | 2017 > 2023 | Black-Orange | R-LEVFRKTM0002 | € 89,95 |
| HUSQVARNA | TC           | 125                     | 2014-2015   | Black-Blue   | R-LEVFRHSQ0001 | € 89,95 |
|           | TC           | 125                     | 2016 > 2023 | Black-Blue   | R-LEVFRHSQ0002 | € 89,95 |
|           | TC           | 250                     | 2014 > 2016 | Black-Blue   | R-LEVFRHSQ0001 | € 89,95 |
|           | TC           | 250                     | 2017 > 2023 | Black-Blue   | R-LEVFRHSQ0002 | € 89,95 |
|           | TE           | 125-250-300             | 2014 > 2016 | Black-Blue   | R-LEVFRHSQ0001 | € 89,95 |
|           | FE           | 250-350-450-501         | 2014 > 2016 | Black-Blue   | R-LEVFRHSQ0001 | € 89,95 |
|           | TE / FE / TX | 125-250-300-350-450-501 | 2017 > 2023 | Black-Blue   | R-LEVFRHSQ0002 | € 89,95 |
|           | FC           | 250-350-450             | 2014-2015   | Black-Blue   | R-LEVFRHSQ0001 | € 89,95 |
|           | FC / FS / FX | 250-350-450             | 2016 > 2023 | Black-Blue   | R-LEVFRHSQ0002 | € 89,95 |
| GAS GAS   | MC           | 125-250                 | 2021 > 2023 | Black-Red    | R-LEVFRGAS0001 | € 89,95 |
|           | EC           | 250-300                 | 2021 > 2023 | Black-Red    | R-LEVFRGAS0001 | € 89,95 |
|           | MCF          | 250-450                 | 2021 > 2023 | Black-Red    | R-LEVFRGAS0001 | € 89,95 |
|           | ECF          | 250-350                 | 2021 > 2023 | Black-Red    | R-LEVFRGAS0001 | € 89,95 |
| FANTIC    | XX / XE      | 125                     | 2021 > 2023 | Black-Blue   | R-LEVFRYZF0001 | € 89,95 |
|           | XXF / XEF    | 250                     | 2021 > 2023 | Black-Blue   | R-LEVFRYZF0002 | € 89,95 |
|           | XXF / XEF    | 450                     | 2021 > 2023 | Black-Blue   | R-LEVFRYZF0003 | € 89,95 |

## CONTROLS-COMANDI SHIFT LEVER / LEVA CAMBIO



€ 32.95



| BRAND      | MODEL       | CC          | YEAR        | COLOR        | CODE          | PRICE         |         |
|------------|-------------|-------------|-------------|--------------|---------------|---------------|---------|
| HONDA      | CR          | 125         | 1983 > 2007 | Black-Red    | R-LEVC00CR003 | € 32,95       |         |
|            | CR          | 250         | 1987 > 2007 | Black-Red    | R-LEVC00CRF06 | € 32,95       |         |
|            | CRF         | 250         | 2004 > 2009 | Black-Red    | R-LEVC00CRF05 | € 32,95       |         |
|            | CRF         | 250         | 2010 > 2023 | Black-Red    | R-LEVC00CRF06 | € 32,95       |         |
|            | CRF         | 450         | 2002 > 2008 | Black-Red    | R-LEVC00CRF07 | € 32,95       |         |
|            | CRF         | 450         | 2009 > 2020 | Black-Red    | R-LEVC00CRF04 | € 32,95       |         |
|            | CRF         | 450         | 2017 > 2023 | Black-Red    | R-LEVC00CRF17 | € 32,95       |         |
|            | CRF-RX      | 450         | 2017 > 2023 | Black-Red    | R-LEVC00CRF17 | € 32,95       |         |
|            | CRFX        | 250         | 2004 > 2019 | Black-Red    | R-LEVC00CRF05 | € 32,95       |         |
|            | CRF-RX      | 250         | 2019 > 2023 | Black-Red    | R-LEVC00CRF06 | € 32,95       |         |
|            | CRFX        | 450         | 2005 > 2018 | Black-Red    | R-LEVC00CRF07 | € 32,95       |         |
|            | CRFX/ CRF-L | 450         | 2019 > 2023 | Black-Red    | R-LEVC00CRF17 | € 32,95       |         |
|            | YAMAHA      | YZ          | 80          | 1993 > 2001  | Black-Blue    | R-LEVC00YZ001 | € 32,95 |
|            |             | YZ          | 85          | 2002 > 2023  | Black-Blue    | R-LEVC00YZ001 | € 32,95 |
| YZ         |             | 125-250     | 1996 > 2023 | Black-Blue   | R-LEVC00YZ002 | € 32,95       |         |
| YZ-X       |             | 125-250     | 2016 > 2023 | Black-Blue   | R-LEVC00YZ002 | € 32,95       |         |
| YZF        |             | 250         | 2006 > 2013 | Black-Blue   | R-LEVC00YZF04 | € 32,95       |         |
| WRF        |             | 250         | 2007 > 2013 | Black-Blue   | R-LEVC00YZF04 | € 32,95       |         |
| YZF        |             | 250         | 2017-2018   | Black-Blue   | R-LEVC00YZF06 | € 32,95       |         |
| YZF        |             | 250         | 2019        | Black-Blue   | R-LEVC00YZF07 | € 32,95       |         |
| WRF/ YZ-FX |             | 250         | 2015 > 2019 | Black-Blue   | R-LEVC00YZF05 | € 32,95       |         |
| WRF        |             | 250         | 2020 > 2023 | Black-Blue   | R-LEVC00YZF07 | € 32,95       |         |
| YZ-FX      |             | 250         | 2020 > 2023 | Black-Blue   | R-LEVC00YZF07 | € 32,95       |         |
| YZF        |             | 250-400-426 | 1998 > 2005 | Black-Blue   | R-LEVC00YZF03 | € 32,95       |         |
| YZF        |             | 250-450     | 2014 > 2016 | Black-Blue   | R-LEVC00YZF05 | € 32,95       |         |
| WRF        |             | 250-400-426 | 1999 > 2006 | Black-Blue   | R-LEVC00YZF03 | € 32,95       |         |
| YZF        |             | 450         | 2003 > 2013 | Black-Blue   | R-LEVC00YZF03 | € 32,95       |         |
| YZF        |             | 450         | 2017        | Black-Blue   | R-LEVC00YZF06 | € 32,95       |         |
| YZF        |             | 450         | 2018-2019   | Black-Blue   | R-LEVC00YZF07 | € 32,95       |         |
| WRF        |             | 450         | 2003 > 2015 | Black-Blue   | R-LEVC00YZF03 | € 32,95       |         |
| WRF        |             | 450         | 2016 > 2018 | Black-Blue   | R-LEVC00YZF05 | € 32,95       |         |
| WRF/YZ-FX  |             | 450         | 2019 > 2023 | Black-Blue   | R-LEVC00YZF07 | € 32,95       |         |
| KAWASAKI   | KX          | 65          | 2000 > 2023 | Black-Red    | R-LEVC00KX002 | € 32,95       |         |
|            | KX          | 125-250-500 | 1994 > 2008 | Black-Red    | R-LEVC00KX004 | € 32,95       |         |
|            | KX-XC       | 250-450     | 2021 > 2023 | Black-Red    | R-LEVC00KXF07 | € 32,95       |         |
|            | KXF         | 250         | 2006 > 2008 | Black-Red    | R-LEVC00KXF06 | € 32,95       |         |
|            | KXF         | 250         | 2009 > 2023 | Black-Red    | R-LEVC00KXF07 | € 32,95       |         |
|            | KXF         | 450         | 2006 > 2015 | Black-Red    | R-LEVC00KXF08 | € 32,95       |         |
|            | KXF         | 450         | 2016 > 2023 | Black-Red    | R-LEVC00KXF07 | € 32,95       |         |
| SUZUKI     | RM          | 80          | 1989 > 2001 | Black-Red    | R-LEVC00RM001 | € 32,95       |         |
|            | RM          | 85          | 2002 > 2023 | Black-Red    | R-LEVC00RM001 | € 32,95       |         |
|            | RM          | 125         | 1998 > 2011 | Black-Red    | R-LEVC00RM003 | € 32,95       |         |
|            | RM          | 250         | 1994 > 2011 | Black-Red    | R-LEVC00RM003 | € 32,95       |         |
|            | RMZ         | 250         | 2007 > 2023 | Black-Red    | R-LEVC00RMZ02 | € 32,95       |         |
|            | RMZ         | 450         | 2008 > 2023 | Black-Red    | R-LEVC00RMZ05 | € 32,95       |         |
| KTM        | SX          | 65          | 2009 > 2023 | Black-Orange | R-LEVC00KTM02 | € 32,95       |         |
|            | SX          | 85          | 2003 > 2017 | Black-Orange | R-LEVC00KTM03 | € 32,95       |         |
|            | SX          | 85          | 2018 > 2023 | Black-Orange | R-LEVC00KTM09 | € 32,95       |         |
|            | SX          | 105         | 2006 > 2017 | Black-Orange | R-LEVC00KTM03 | € 32,95       |         |
|            | SX          | 125-150     | 2001 > 2015 | Black-Orange | R-LEVC00KTM05 | € 32,95       |         |
|            | SX / XC-W   | 125-150     | 2016 > 2023 | Black-Orange | R-LEVC00KTM06 | € 32,95       |         |

| BRAND         | MODEL         | CC              | YEAR   | COLOR        | CODE          | PRICE         |         |
|---------------|---------------|-----------------|--|--------------|---------------|---------------|---------|
| KTM           | SX            | 250-300         | 2005 > 2016  | Black-Orange | R-LEVC00KTM04 | € 32,95       |         |
|               | SX            | 250             | 2017 > 2023  | Black-Orange | R-LEVC00KTM07 | € 32,95       |         |
|               | SXF / XC-F    | 250             | 2005 > 2012  | Black-Orange | R-LEVC00KTM06 | € 32,95       |         |
|               | SXF           | 250             | 2013 > 2015  | Black-Orange | R-LEVC00KTM05 | € 32,95       |         |
|               | SXF           | 350             | 2011 > 2015  | Black-Orange | R-LEVC00KTM05 | € 32,95       |         |
|               | SXF           | 450             | 2009 > 2012  | Black-Orange | R-LEVC00KTM05 | € 32,95       |         |
|               | SXF / XC-F    | 450             | 2013 > 2015  | Black-Orange | R-LEVC00KTM06 | € 32,95       |         |
|               | SXF           | 250-350-450     | 2016 > 2023  | Black-Orange | R-LEVC00KTM08 | € 32,95       |         |
|               | EXC           | 125-200         | 2001 > 2016  | Black-Orange | R-LEVC00KTM05 | € 32,95       |         |
|               | EXC           | 250-300         | 2001 > 2003  | Black-Orange | R-LEVC00KTM05 | € 32,95       |         |
|               | EXC           | 250-300         | 2005 > 2016  | Black-Orange | R-LEVC00KTM04 | € 32,95       |         |
|               | EXC / XC-W/XC | 250-300         | 2017 > 2023  | Black-Orange | R-LEVC00KTM07 | € 32,95       |         |
|               | EXCF          | 250             | 2001 > 2005  | Black-Orange | R-LEVC00KTM06 | € 32,95       |         |
|               | EXCF          | 250             | 2009 > 2011  | Black-Orange | R-LEVC00KTM05 | € 32,95       |         |
|               | EXCF          | 250-350         | 2012 > 2016  | Black-Orange | R-LEVC00KTM06 | € 32,95       |         |
|               | EXCF          | 400             | 2000 > 2007 / 2009 > 2011                                | Black-Orange | R-LEVC00KTM06 | € 32,95       |         |
|               | EXCF          | 450             | 2003 > 2016  | Black-Orange | R-LEVC00KTM06 | € 32,95       |         |
|               | EXCF          | 500 > 530       | 2001 > 2016  | Black-Orange | R-LEVC00KTM06 | € 32,95       |         |
|               | EXCF          | 250-350-450-500 | 2017 > 2023  | Black-Orange | R-LEVC00KTM08 | € 32,95       |         |
|               | SMR           | 450-525         | 2004 > 2007 - 2013 > 2014 (450)<br>2004 > 2007 (525/560) | Black-Orange | R-LEVC00KTM06 | € 32,95       |         |
|               | HUSQVARNA     | FREERIDE        | 250R   | 2014 > 2023  | Black-Orange  | R-LEVC00KTM04 | € 32,95 |
|               |               | CR / WR         | 250-300  | 2000 > 2013  | Black-Red     | R-LEVC00HSQ02 | € 32,95 |
|               |               | TC / TE         | 250-310-450-510  | 2003 > 2013  | Black-Red     | R-LEVC00HSQ01 | € 32,95 |
| CR/WR/WRE/SMS |               | 125             | 1999 > 2013  | Black-Red    | R-LEVC00HSQ01 | € 32,95       |         |
| TC            |               | 85              | 2014 > 2017  | Black-Blue   | R-LEVC00HSQ03 | € 32,95       |         |
| TC            |               | 85              | 2018 > 2023  | Black-Blue   | R-LEVC00HSQ09 | € 32,95       |         |
| TC            |               | 125             | 2014-2015  | Black-Blue   | R-LEVC00HSQ05 | € 32,95       |         |
| TC            |               | 125             | 2016 > 2023  | Black-Blue   | R-LEVC00HSQ06 | € 32,95       |         |
| TE            |               | 125             | 2014 > 2016  | Black-Blue   | R-LEVC00HSQ05 | € 32,95       |         |
| FE            |               | 450-501         | 2014 > 2016  | Black-Blue   | R-LEVC00HSQ06 | € 32,95       |         |
| TC / TE       |               | 250-300         | 2014 > 2016  | Black-Blue   | R-LEVC00HSQ04 | € 32,95       |         |
| TE / TX/TC    |               | 250-300         | 2017 > 2023  | Black-Blue   | R-LEVC00HSQ07 | € 32,95       |         |
| TX            |               | 125-150         | 2017 > 2023  | Black-Blue   | R-LEVC00HSQ06 | € 32,95       |         |
| FC            |               | 250-350         | 2014-2015  | Black-Blue   | R-LEVC00HSQ05 | € 32,95       |         |
| FC            |               | 450             | 2014-2015  | Black-Blue   | R-LEVC00HSQ06 | € 32,95       |         |
| FC            |               | 250-350-450     | 2016 > 2023  | Black-Blue   | R-LEVC00HSQ08 | € 32,95       |         |
| FE            |               | 250-350         | 2014 > 2016  | Black-Blue   | R-LEVC00HSQ06 | € 32,95       |         |
| FE            |               | 250-350-450-501 | 2017 > 2023  | Black-Blue   | R-LEVC00HSQ08 | € 32,95       |         |
| GAS-GAS       |               | EC              | 250-300  | 2006 > 2020  | Black-Red     | R-LEVC00GAS01 | € 32,95 |
|               |               | MC              | 65   | 2021 > 2023  | Black-Red     | R-LEVC00GAS02 | € 32,95 |
|               |               | MC              | 85   | 2021 > 2023  | Black-Red     | R-LEVC00GAS03 | € 32,95 |
|               |               | MC / EC         | 125  | 2021 > 2023  | Black-Red     | R-LEVC00GAS04 | € 32,95 |
|               |               | MC / EC         | 250-300  | 2021 > 2023  | Black-Red     | R-LEVC00GAS05 | € 32,95 |
|               | MCF / ECF     | 250-350-450     | 2021 > 2023  | Black-Red    | R-LEVC00GAS06 | € 32,95       |         |
| BETA          | RR            | 350 > 530       | 2013 > 2023  | Black-Red    | R-LEVC00CRF06 | € 32,95       |         |
|               | RR            | 250-300         | 2013 > 2023  | Black-Red    | R-LEVC00BET00 | € 32,95       |         |
| FANTIC        | TZ / TF       | 125-250-300     | 2011 > 2015  | Black-Red    | R-LEVC00GAS01 | € 32,95       |         |
|               | XX / XE       | 125-250         | 2021 > 2023  | Black-Blue   | R-LEVC00YZ002 | € 32,95       |         |
|               | XXF / XEF     | 250-450         | 2021 > 2023  | Black-Blue   | R-LEVC00YZF07 | € 32,95       |         |

**CONTROLS-COMANDI** REPLACEMENT BRAKE PEDAL AND SHIFT LEVER  
RICAMBI PEDALE FRENO E LEVA CAMBIO



R-REPLEVFRARO

CNC machined brake tip, concept and designed by Rtech R&D



R-REPLEVFRRS0



R-REPLEVFRBLO

Shift lever replacement tip **Included fastening pin**  
Ricambio puntali leve cambio **Incluso perno di fissaggio**



R-REPLEVCOAR1

R-REPLEVCOBL1

R-REPLEVCORS1

| YEAR                                     | COLOR  | CODE          | PRICE   |
|--|--------|---------------|---------|
| Cnc machined brake pedal replacement tip | Orange | R-REPLEVFRARO | € 36,95 |
|  | Blue   | R-REPLEVFRBLO | € 36,95 |
|  | Red    | R-REPLEVFRRS0 | € 36,95 |
| Shift lever replacement tip              | Orange | R-REPLEVCOAR1 | € 21,95 |
|  | Blue   | R-REPLEVCOBL1 | € 21,95 |
|  | Red    | R-REPLEVCORS1 | € 21,95 |

# CONTROLS-COMANDI LIFT CONTROL



Lift control  
**R-LIFTCTRS001**

€ 59.95

Lift control  
**R-LIFTCTNR001**

The diameter of the ring  
It is referred to the area  
positioning on the fork  
usually in correspondence  
to the ring seal.

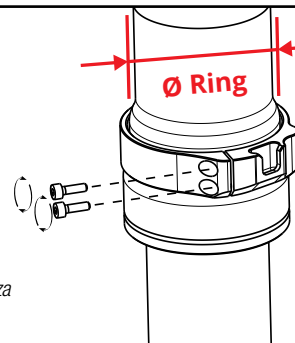

*Il diametro dell'anello  
è riferito alla zona  
di posizionamento  
sul fodero della forcella  
solitamente in corrispondenza  
dell'anello paraolio.*

| BRAND     | MODEL               | CC                  | YEAR        | DESCRIPTION      | COLOR | CODE          | PRICE   |
|-----------|---------------------|---------------------|-------------|------------------|-------|---------------|---------|
| HONDA     | CR / CRF            | 80-85-150           | 1997 > 2023 | Ø 49.5 SHOWA     | Black | R-LIFTCTNR006 | € 59,95 |
|           | CR                  | 125                 | 1997 > 2007 | Ø 64 KAYABA      | Black | R-LIFTCTNR002 | € 59,95 |
|           |                     |                     |             |                  | Red   | R-LIFTCTRS002 |         |
|           |                     |                     |             |                  | Gold  | R-LIFTCTOR002 |         |
|           | CR                  | 250-500             | 1997 > 2007 | Ø 57 SHOWA       | Black | R-LIFTCTNR001 | € 59,95 |
|           |                     |                     |             |                  | Red   | R-LIFTCTRS001 |         |
|           | CRF / CRF-RX / CRFX | 250-450             | 2002 > 2023 | Ø 57 SHOWA       | Black | R-LIFTCTNR001 | € 59,95 |
|           |                     |                     |             |                  | Red   | R-LIFTCTRS001 |         |
| YAMAHA    | YZ                  | 80-85               | 1997 > 2023 | Ø 54 KAYABA      | Black | R-LIFTCTNR005 | € 59,95 |
|           | YZ / YZF / WRF      | 125 > 450           | 2005 > 2023 | Ø 64 KAYABA      | Black | R-LIFTCTNR002 | € 59,95 |
|           |                     |                     |             |                  | Red   | R-LIFTCTRS002 |         |
|           |                     |                     |             |                  | Gold  | R-LIFTCTOR002 |         |
|           | YZF                 | 250-450             | 2010 > 2023 | Ø 57 SHOWA       | Black | R-LIFTCTNR001 | € 59,95 |
|           |                     |                     |             |                  | Gold  | R-LIFTCTRS001 |         |
|           | YZF                 | 250-450             | 2005 > 2023 | Ø 64 KAYABA      | Black | R-LIFTCTNR002 | € 59,95 |
|           |                     |                     |             |                  | Gold  | R-LIFTCTOR002 |         |
|           |                     |                     |             |                  | Red   | R-LIFTCTRS002 |         |
| KAWASAKI  | KX                  | 80-85               | 2000 > 2023 | Ø 54 KAYABA      | Black | R-LIFTCTNR005 | € 59,95 |
|           | KX                  | 125-250             | 1999 > 2008 | Ø 64 KAYABA      | Black | R-LIFTCTNR002 | € 59,95 |
|           |                     |                     |             |                  | Red   | R-LIFTCTRS002 |         |
|           |                     |                     |             |                  | Gold  | R-LIFTCTOR002 |         |
|           | KXF                 | 250                 | 2004-2005   | Ø 64 KAYABA      | Black | R-LIFTCTNR002 | € 59,95 |
|           |                     |                     |             |                  | Red   | R-LIFTCTRS002 |         |
|           |                     |                     |             |                  | Gold  | R-LIFTCTOR002 |         |
|           | KXF / KX-XC         | 250-450             | 2006 > 2023 | Ø 57 SHOWA       | Black | R-LIFTCTNR001 | € 59,95 |
|           |                     |                     |             |                  | Red   | R-LIFTCTRS001 |         |
| SUZUKI    | RM                  | 80-85               | 1997 > 2023 | Ø 49.5 SHOWA     | Black | R-LIFTCTNR006 | € 59,95 |
|           | RM                  | 125                 | 1999 > 2003 | Ø 57 SHOWA       | Black | R-LIFTCTNR001 | € 59,95 |
|           |                     |                     |             |                  | Red   | R-LIFTCTRS001 |         |
|           | RM                  | 250                 | 2001 > 2003 | Ø 64 KAYABA      | Black | R-LIFTCTNR002 | € 59,95 |
|           |                     |                     |             |                  | Red   | R-LIFTCTRS002 |         |
|           |                     |                     |             |                  | Gold  | R-LIFTCTOR002 |         |
|           | RMZ                 | 250                 | 2004 > 2006 | Ø 64 KAYABA      | Black | R-LIFTCTNR002 | € 59,95 |
|           |                     |                     |             |                  | Red   | R-LIFTCTRS002 |         |
|           |                     |                     |             |                  | Gold  | R-LIFTCTOR002 |         |
|           | RMZ                 | 250                 | 2007 > 2023 | Ø 57 SHOWA       | Black | R-LIFTCTNR008 | € 59,95 |
|           | RMZ                 | 450                 | 2005 > 2023 | Ø 57 SHOWA       | Black | R-LIFTCTNR008 | € 59,95 |
| KTM       | SX                  | 65                  | 2002 > 2023 | Ø 45.5 WP        | Black | R-LIFTCTNR065 | € 59,95 |
|           | SX                  | 85                  | 2003 > 2023 | Ø 53 WP          | Black | R-LIFTCTNR085 | € 59,95 |
|           | SX/XC               | 125 > 530           | 2003 > 2023 | Ø 59 WP          | Black | R-LIFTCTNR004 | € 59,95 |
|           | XC-W/XCF/SMR        | 125 > 530           | 2003 > 2023 | Ø 59 WP          | Black | R-LIFTCTNR004 | € 59,95 |
| HUSQVARNA | TC                  | 65                  | 2017 > 2023 | Ø 45.5 WP        | Black | R-LIFTCTNR065 | € 59,95 |
|           | TC                  | 85                  | 2014 > 2023 | Ø 53 WP          | Black | R-LIFTCTNR085 | € 59,95 |
|           | TC-FC-FE-TE-FX-FS   | 125 > 501           | 2014 > 2023 | Ø 59 WP          | Black | R-LIFTCTNR004 | € 59,95 |
| GAS GAS   | MC                  | 65                  | 2021 > 2023 | Ø 45.5 WP        | Black | R-LIFTCTNR065 | € 59,95 |
|           | MC                  | 85                  | 2021 > 2023 | Ø 53 WP          | Black | R-LIFTCTNR085 | € 59,95 |
|           | MC/MC-F/RC/EC-F     | 125-250-300-350-450 | 2021 > 2023 | Ø 59 WP          | Black | R-LIFTCTNR004 | € 59,95 |
| FANTIC    | XX / XE / XXF / XEF | 125-250-450         | 2021 > 2023 | Ø 64 KAYABA      | Gold  | R-LIFTCTOR002 | € 59,95 |
|           |                     |                     |             |                  | Black | R-LIFTCTNR002 | € 59,95 |
| UNIVERSAL |                     |                     |             | Ø 61,7 MARZOCCHI | Black | R-LIFTCTNR007 | € 59,95 |

## CONTROLS-COMANDI FORK BLEEDER / VALVOLE SFIATO FORCELLA



€ 23.95



R-VALVFORC1BL



R-VALVFORC1RS



R-VALVFORCONR

| BRAND                 | COLOR | CODE           | PRICE   |
|-----------------------|-------|----------------|---------|
| WP/MARZOCCHI M4       | Black | R-VALVFORCONR  | € 23,95 |
| SHOWA/KAYABA/SACHS M5 | Blue  | R-VALVFORC1BL* | € 23,95 |
| SHOWA/KAYABA/SACHS M5 | Red   | R-VALVFORC1RS* | € 23,95 |

\*adapt on Kayaba YZF 2010 > 2022 - \*adatte a Kayaba YZF 2010 > 2022



## CONTROLS-COMANDI GAS TANK VALVE / VALVOLE SFIATO SERBATOIO



R-VALVSF000AR



R-VALVSF000BL



R-VALVSF000RS

€ 11.95

| COLOR  | CODICE        | PRICE   |
|--------|---------------|---------|
| Orange | R-VALVSF000AR | € 11,95 |
| Blue   | R-VALVSF000BL | € 11,95 |
| Red    | R-VALVSF000RS | € 11,95 |

## CONTROLS-COMANDI SPECIAL STEEL SCREWS / VITERIA SPECIALE IN ACCIAIO



R-VTBRBM08X30



R-VTESFL08X30



R-VTBRRB10X40



R-VTESFL08X35

For the application on triple clamps, handlebar supports and in any case in which a high level of safety is required.  
*Viteria ad alta resistenza per applicazioni che richiedono standard di sicurezza molto elevata.*  
*Indicate per piastre forcella, pedane, supporti manubrio ecc.*

| DESCRIPTION                                       | COLOR      | CODE          | PRICE   |
|---|------------|---------------|---------|
| Screws flanged hex head CH 10 MM 8.8 M8X18MM 15PZ | Galvanized | R-VTESFL08X18 | € 6,95  |
| Screws flanged hex head CH 10 MM 8.8 M8X30MM 15PZ | Galvanized | R-VTESFL08X30 | € 7,95  |
| Screws flanged hex head CH 10 MM 8.8 M8X35MM 15PZ | Galvanized | R-VTESFL08X35 | € 8,95  |
| Screws flanged hex head CH 10 MM 8.8 M8X40MM 15PZ | Galvanized | R-VTESFL08X40 | € 9,95  |
| Screws flanged hex head CH 10 MM 8.8 M8X50MM 15PZ | Galvanized | R-VTESFL08X50 | € 11,95 |
| Screws flanged hex head CH 10 MM 8.8 M8X60MM 15PZ | Galvanized | R-VTESFL08X60 | € 13,95 |
| Screws reduced hex head CH 8 10.9 M10X25 8pz      | Galvanized | R-VTBRRB10X25 | € 9,95  |
| Screws reduced hex head CH 8 10.9 M10X40 8pz      | Galvanized | R-VTBRRB10X40 | € 11,95 |
| Screws rounded hex head CH 6 8.8 M8x20 15pz       | Galvanized | R-VTBRBM08X20 | € 7,95  |
| Screws rounded hex head CH 6 8.8 M8x30 15pz       | Galvanized | R-VTBRBM08X30 | € 8,95  |
| Screws rounded hex head CH 6 8.8 M8x40 15pz       | Galvanized | R-VTBRBM08X40 | € 9,95  |





## **APPAREL**

*Corporate sweatshirt >pag 314*

*Corporate t-shirt >pag 314*

*Corporate shirt >pag 315*

*Cap - Beanie corporate - Bandana >pag 315*

*Bomber Jacket corporate - Gilet corporate >pag 316*

*Pants - Short corporate >pag 317*

## **RACE-MERCHANDISING**

*Waist pack corporate >pag 318*

*Multifunction backpack >pag 318*

*Water bottle >pag 318*

*Rtech umbrella >pag 319*

*Rtech folding chair >pag 319*

*Rtech LED torch >pag 319*

*Rtech shoppers >pag 319*

*Rtech key holder >pag 319*

*Rtech race tent >pag 320*

*Rtech race mat >pag 321*

*Rtech flag >pag 321*

*Rtech product display >pag 321*

**CORPORATE SWEATSHIRT**

52% cotton - 48% polyester. With hood and metal zipper, slim fit. Lightweight and soft touch fabric. White lanyards. Pouch pockets, in the right pocket there is a small hidden opening for earphones.

**FELPA CON LOGHI RICAMATI**

Felpe 52% cotone e 48% poliestere. Con cappuccio e zip in metallo, slim fit. Tessuto leggero dal tocco morbido, cappuccio foderato a doppio strato. Cordini a contrasto in colore bianco. Tasche a marsupio, nella tasca destra è presente una piccola apertura nascosta per gli auricolari. Polsini e orlo a costine.



| DESCRIPTION                             | COLOR         | CODE               | PRICE   |
|---|---------------|--------------------|---------|
| Cotton sweatshirt embroidery - Size S   | Heather black | <b>FELCOR00S16</b> | € 53,95 |
| Cotton sweatshirt embroidery - Size XS  | Heather black | <b>FELCOR0XS16</b> | € 53,95 |
| Cotton sweatshirt embroidery - Size M   | Heather black | <b>FELCOR00M16</b> | € 53,95 |
| Cotton sweatshirt embroidery - Size L   | Heather black | <b>FELCOR00L16</b> | € 53,95 |
| Cotton sweatshirt embroidery - Size XL  | Heather black | <b>FELCOR0XL16</b> | € 53,95 |
| Cotton sweatshirt embroidery - Size XXL | Heather black | <b>FELCORXXL16</b> | € 53,95 |

**APPAREL-ABBIGLIAMENTO CORPORATE T-SHIRT WITH PRINTED LOGO T-SHIRT CON LOGHI STAMPATI**

Short sleeve. Regular fit. Fabric: 100% Cotton Ring Spun Weight: 160 gr/mq

T-shirt girocollo manica corta, girocollo con bordo a costine orlato, cuciture laterali, Regular fit. Tessuto: 100% cotone Ring Spun Peso: 160 gr/mq



| DESCRIPTION                                     | COLOR | CODE               | PRICE   |
|---|-------|--------------------|---------|
| T-shirt Corporate - Cotton - Size S - Printed   | Black | <b>TSHCOR00S16</b> | € 21,95 |
| T-shirt Corporate - Cotton - Size M - Printed   | Black | <b>TSHCOR00M16</b> | € 21,95 |
| T-shirt Corporate - Cotton - Size L - Printed   | Black | <b>TSHCOR00L16</b> | € 21,95 |
| T-shirt Corporate - Cotton - Size XL - Printed  | Black | <b>TSHCOR0XL16</b> | € 21,95 |
| T-shirt Corporate - Cotton - Size XXL - Printed | Black | <b>TSHCORXXL16</b> | € 21,95 |



**SHORT SLEEVE SHIRT WITH EMBROIDERED LOGOS  
CAMICIA MANICA CORTA CON LOGHI RICAMATI**



80% polyester  
20% viscose

| DESCRIPTION   | COLOR       | CODE                | PRICE   |
|---|-------------|---------------------|---------|
| Short sleeve shirt 100% cotton - Embroided - Size S   | White-Black | <b>CAMBNNR0S15</b>  | € 42,95 |
| Short sleeve shirt 100% cotton - Embroided - Size M   | White-Black | <b>CAMBNNROM15</b>  | € 42,95 |
| Short sleeve shirt 100% cotton - Embroided - Size L   | White-Black | <b>CAMBNNROL15</b>  | € 42,95 |
| Short sleeve shirt 100% cotton - Embroided - Size XL  | White-Black | <b>CAMBNNRXL15</b>  | € 42,95 |
| Short sleeve shirt 100% cotton - Embroided - Size XXL | White-Black | <b>CAMBNNRXXL15</b> | € 42,95 |

APPAREL-ABBIGLIAMENTO CAP - BEANIE / CAPPELLINO



Bandana  
**BANDANA0019** € 9.95



Corporate cap 2016  
60% polyester - 40% wool  
**One size**  
**CAPCORN0016**

€ 13.95

100% heavy brushed cotton  
**One size**  
Corporate cap 2015  
**CAPCORN0015**

€ 13.95

100% polyester  
One size Beanie corporate  
**BEANIENR016**

€ 13.95

**NYLON BOMBER JACKET WINDSTOPPER**

Corporate jacket, unisex.  
 Fleece lining.  
 Waterproof and breathable fabric.  
 Side pockets with zipper  
 Material: 100% nylon outer, polyester lining



Fleece lining  
 Interno in pile



Internal pocket  
 Taschino interno

**BOMBER 4 STAGIONI IN NYLON ANTIVENTO CON IMBOTTITURA IN PILE CON RICAMO**

Giubbino corporate unisex  
 Fodera interna in pile  
 Idrorepellente e traspirante  
 Cuciture termo-nastrate  
 Costine ai polsi ed in vita  
 Tasche laterali con cerniera  
 Fodera con cerniera  
 Materiale: 100% nylon esterno, fodera in poliestere

| DESCRIPTION                                  | COLOR | CODE               | PRICE   |
|--|-------|--------------------|---------|
| Nylon bomber jacket - Embroidered - Size S   | Black | <b>BOMBNR00S15</b> | € 74,95 |
| Nylon bomber jacket - Embroidered - Size M   | Black | <b>BOMBNR00M15</b> | € 74,95 |
| Nylon bomber jacket - Embroidered - Size L   | Black | <b>BOMBNR00L15</b> | € 74,95 |
| Nylon bomber jacket - Embroidered - Size XL  | Black | <b>BOMBNR0XL15</b> | € 74,95 |
| Nylon bomber jacket - Embroidered - Size XXL | Black | <b>BOMBNRXXL15</b> | € 74,95 |

**APPAREL-ABBIGLIAMENTO CORPORATE QUILTED GILET EMBROIDERED GILET TRAPUNTATO CON RICAMO**

Full zip and high collar.  
 Two front pockets with zip.  
 Inside pocket.  
 Materials: 100% polyester 50D  
 Lining: 100% Polyester Taffeta  
 Padding: 100% polyester.



Gilet smancato imbottito con zip intera e colletto alto, due tasche frontali con cerniera, taschino interno.  
 Materiale esterno: 100% poliestere 50D  
 Fodera: 100% poliestere Taffeta  
 Imbottitura: 100% poliestere.

| DESCRIPTION                            | COLOR | CODE                | PRICE   |
|--|-------|---------------------|---------|
| Quilted gilet - Embroidered - Size S   | Black | <b>GILETNR0S16</b>  | € 63,95 |
| Quilted gilet - Embroidered - Size M   | Black | <b>GILETNR0M16</b>  | € 63,95 |
| Quilted gilet - Embroidered - Size L   | Black | <b>GILETNR0L16</b>  | € 63,95 |
| Quilted gilet - Embroidered - Size XL  | Black | <b>GILETNRXL16</b>  | € 63,95 |
| Quilted gilet - Embroidered - Size XXL | Black | <b>GILETNRXXL16</b> | € 63,95 |

**CORPORATE PANTS**  
**PANTALONI CORPORATE CON RICAMO**



Corporate PANTS - Cotton - Embroidered  
*Pantaloni corporate LUNGHI in cotone con patch su tasconi e retro*

| DESCRIPTION                                       | COLOR      | CODE         | PRICE   |
|---|------------|--------------|---------|
| Corporate PANTS - Cotton - Embroidered - Size S   | Anthracite | PANTSNR0S16  | € 63,95 |
| Corporate PANTS - Cotton - Embroidered - Size M   | Anthracite | PANTSNR0M16  | € 63,95 |
| Corporate PANTS - Cotton - Embroidered - Size L   | Anthracite | PANTSNR0L16  | € 63,95 |
| Corporate PANTS - Cotton - Embroidered - Size XL  | Anthracite | PANTSNR0XL16 | € 63,95 |
| Corporate PANTS - Cotton - Embroidered - Size XXL | Anthracite | PANTSNRXXL16 | € 63,95 |

**APPAREL-ABBIGLIAMENTO**  
**CORPORATE SHORT**  
**SHORT CORPORATE CON RICAMO**

Shorts inTwill.  
Pocket on the right leg.  
Two back pockets.  
Mobile phone pocket.  
Fabric: 65% polyester - 35% cotton  
Weight: 245 gr

*Pantaloncino da lavoro in Twill.  
Capiente tasca sulla gamba destra,  
design moderno, due tasche posteriori  
con risvolto, tasca portacellulare.  
Tessuto: 65% poliestere - 35% cotone  
Peso: 245 gr*



Corporate SHORT - Cotton - Embroidered

| DESCRIPTION                                       | COLOR | CODE         | PRICE   |
|---|-------|--------------|---------|
| Corporate SHORT - Cotton - Embroidered - Size S   | Black | SHORTNR0S16  | € 53,95 |
| Corporate SHORT - Cotton - Embroidered - Size M   | Black | SHORTNR0M16  | € 53,95 |
| Corporate SHORT - Cotton - Embroidered - Size L   | Black | SHORTNR0L16  | € 53,95 |
| Corporate SHORT - Cotton - Embroidered - Size XL  | Black | SHORTNR0XL16 | € 53,95 |
| Corporate SHORT - Cotton - Embroidered - Size XXL | Black | SHORTNRXXL16 | € 53,95 |

**WAIST PACK**

Waist pack + water bottle.

**MARSUPIO TECNICO**

Marsupio di nylon spalmato in pvc con bordi riflettenti.  
 Dispone di un'ampia tasca centrale porta attrezzi e di due tasche laterali, una delle quali ideata come portaborraccia e l'altra per smartphone.



**WATER BOTTLE INCLUDED**



R-MARRTNRRS08

€ 64.95

**RACE-GARA WATER BOTTLE**



Water bottle - 1/2 Lt  
 Borraccia Rtech - 1/2 Lt  
 R-WATERBNR1

€ 6.95

**RACE-GARA CORPORATE BACKPACK / ZAINO CORPORATE**

**18 L.**



**RTECH HEAVY DUTY MULTIFUNCTION BACKPACK**

Heavy duty nylon with printed logos and rubber zipper pulls and padded mesh back pad, 2 large main compartments with multiple accessory pockets, padded tablet pocket, sunglasses pocket and exterior mesh bottle pocket.

**ZAINO MULTIFUNZIONE CORPORATE**

Robusto nylon con loghi stampati e tiretti in gomma con cerniera e imbottitura posteriore in mesh, 2 ampi scomparti principali con numerose tasche accessorie, tasca imbottita per tablet, tasca per occhiali da sole e tasca per bottiglia esterna in rete.

BACKPACK018

€ 63.95



**MERCHANDISING TELESCOPIC UMBRELLA**  
**OMBRELLINO CORPORATE**

R-UMBRELLA016  
diameter / diametro 126 cm  
**€ 32.95**



R-CHAIR0018NR  
**€ 42.95**

**MERCHANDISING LED TORCH / TORCIA A LED**



LED torch  
Torcia a LED  
**TORCIA00019**

**€ 12.95**

**MERCHANDISING SHOPPERS / BORSE**



Multipurpose Rtech bag with laces  
Sacco multiuso con lacci  
**SACCART0019**

**MERCHANDISING**  
**KEY HOLDER / PORTACHIAVI**



**PORTACHIART**

**€ 2.45**



**PORTACH0019**



R-TENTRTECHNR

€ 139.95

**RTECH RACE TENT 3 X 3 MT**

Strong steel frame tent, comes with velcro on the perimeter to apply side walls covers.  
Fabric made by waterproof PVC.  
Weight 21 kg.

**GAZEBO RTECH 3 X 3 MT**

Robusto gazebo in acciaio, con velcro sul perimetro per rapida applicazione pareti di copertura in PVC impermeabile.  
Dotato di sacca per trasporto.  
Peso 21 kg.

**RTECH PVC GUTTER CONNECTION TENT WITH VELCRO  
GRONDAIA DI COLLEGAMENTO CON VELCRO**

R-GUTTERNR001

€ 21.95

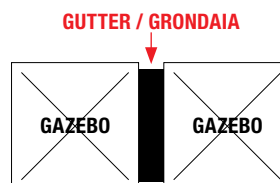

**RTECH BRANDED WALL TENT WITH STRAPS - 3 x 2 mt  
PARETE PER GAZEBO RTECH CON VELCRO 3 X 2 mt**

R-WALLTENTNR1

€ 33.95



**RTECH BRANDED HALF WALL TENT WITH STRAPS 3 x 0,9 mt  
MEZZA PARETE PER GAZEBO RTECH CON VELCRO 3 X 0,9 mt**

R-WALLTENTNR2

€ 27.95



**RTECH ALLOY TENT CONNECTOR FOR HALF WALL - LENGHT 3 mt  
BARRA TENSIONATRICE PER MEZZA PARETE 3 mt**

R-CONNTENTAL1

€ 29.95



## RACE-GARA

### RACE MAT 2 X 0.83 MT

### TAPPETO SOTTOMOTO 2 X 0.83 MT

Rtech branded PVC floor mat, complies with FIM.  
Tappeto sottomoto in PVC conforme alle normative FIM

**R-MATRTECHNR1**

**€ 52.95**

## MERCHANDISING

### HANDLEBAR DISPLAY

### ESPOSITORE MANUBRI



**R-ESP00000002**

**€ 8.95**



## RACE-GARA

### RTECH FLAG

### BANDIERA RTECH

Rtech flag 2 x 0,5 mt  
Bandiera Rtech 2 x 0,5 mt

**R-FLAGRTECH01**

**€ 47.95**

## MERCHANDISING

### PRODUCT DISPLAY

### CORNER ESPOSITIVO

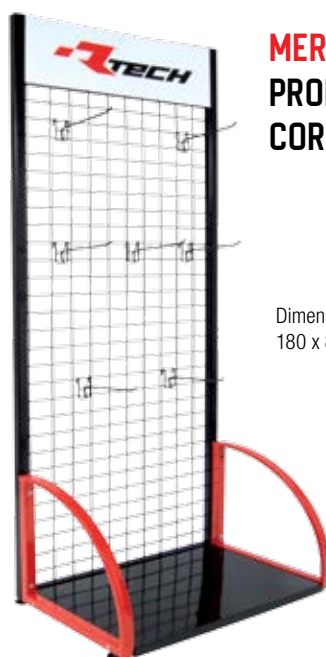

Dimension / Dimensioni  
180 x 85 x 40 cm

**R-ESP00000004**



|                     |          |
|---------------------|----------|
| Frame parts         | pag. 322 |
| Brake parts         | pag. 332 |
| Ergal screws        | pag. 338 |
| Shock link triangle | pag. 341 |
| Engine plugs        | pag. 343 |
| Engine parts        | pag. 343 |
| Trial parts         | pag. 347 |

Specify when ordering the size of the bar supports, if not specified, the triple clamps are sold with **30 mm barsupports for Japanese and 35 mm for European bikes.**

*Specificare al momento dell'ordine la misura del supporto manubrio desiderata, se non specificato le piastre vengono vendute con i supporti manubrio da 30 mm per le moto giapponesi e da 35 mm per le moto europee.*



| CODE           | HEIGHT | APPLICATION ON 2D/3D TRIPLE CLAMPS  | PRICE   |
|----------------|--------|---|---------|
| 100.SUPPMAN.30 | 30 mm  | 100.062.004 / 100.062A.004 / 100.062B.004   | € 53,90 |
| 100.SUPPMAN.35 | 35 mm  | 100.062.004 / 100.062A.004 / 100.062B.004   | € 53,90 |
| 100.SUPPMAN.40 | 40 mm  | 100.062.004 / 100.062A.004 / 100.062B.004   | € 53,90 |
| 200.SUPPMAN.30 | 30 mm  | 200.062.003 (20-22-24) / 200.062.002 (20-22)<br>300.062A.002 / 300.062B.002 / 300.062.002 / 300.062C.002<br>750.062.004 (20-23) / 700.062.002 / 500.062.005 | € 53,90 |
| 200.SUPPMAN.35 | 35 mm  | 200.062.003 (20-22-24) / 200.062.002 (20-22)<br>300.062A.002 / 300.062B.002 / 300.062.002 / 300.062C.002<br>750.062.004 (20-23) / 700.062.002 / 500.062.005 | € 53,90 |
| 200.SUPPMAN.40 | 40 mm  | 200.062.003 (20-22-24) / 200.062.002 (20-22)<br>300.062A.002 / 300.062B.002 / 300.062.002 / 300.062C.002<br>750.062.004 (20-23) / 700.062.002 / 500.062.005 | € 53,90 |

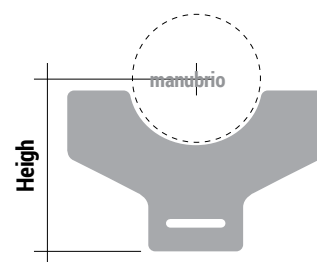



Piastre sterzo 2D  
100.062A.004

**€ 488,90**

Specify when ordering the size of the bar supports, if not specified, the triple clamps are sold with **30 mm barsupports for Japanese and 35 mm for European bikes.**

*Specificare al momento dell'ordine la misura del supporto manubrio desiderata, se non specificato le piastre vengono vendute con i supporti manubrio da 30 mm per le moto giapponesi e da 35 mm per le moto europee.*

**Complete with:**

- Upper clamp
- Lower clamp
- Axle
- Handlebar supports diam. 28
- Steering stem bolt
- Ring

**Complete di:**

- piastra superiore
- piastra inferiore
- canotto
- supporto manubrio mm 28
- dado piastra sterzo
- ghiera



Know the offset of your model before making the order  
*Verificare l'offset del proprio modello prima di effettuare l'acquisto*



| BRAND     | MODEL        | ENGINE          | YEAR        | OFFSET      | COLOR  | CODE             | PRICE    |
|-----------|--------------|-----------------|-------------|-------------|--------|------------------|----------|
| HONDA     | CRF          | 250             | 2010 > 2017 | Offset 20mm | Red    | 100.062.004      | € 488,90 |
|           | CRF          | 450             | 2009 > 2016 | Offset 20mm | Red    | 100.062.004      | € 488,90 |
|           | CRF          | 250-450         | 2017 > 2021 | Offset 20mm | Red    | 100.062A.004     | € 488,90 |
|           | CRF          | 250-450         | 2021>2023   | Offset 22mm | Red    | 100.062B.004     | € 488,90 |
| YAMAHA    | WRF          | 250-450         | 2015 > 2023 | Offset std  | Blue   | 300.062.002      | € 488,90 |
|           | YZ           | 125             | 2015 > 2023 | Offset std  | Blue   | 300.062A.002     | € 488,90 |
|           | YZ           | 250             | 2015 > 2023 | Offset std  | Blue   | 300.062B.002     | € 488,90 |
|           | YZF          | 250-450         | 2015 > 2023 | Offset std  | Blue   | 300.062C.002     | € 488,90 |
| KTM       | SX-SXF       | 125 > 530       | 2013 > 2023 | Offset 20mm | Orange | 200.062.003-20*  | € 488,90 |
|           | SX-SXF       | 125 > 530       | 2013 > 2022 | Offset 22mm | Orange | 200.062.003-22*  | € 488,90 |
|           | SX-SXF       | 125 > 450       | 2023        | Offset 22mm | Orange | 200.062A.003-22* | € 488,90 |
|           | EXC-EXCF     | 125 > 530       | 2014 > 2023 | Offset 20mm | Orange | 200.062.003-20*  | € 488,90 |
|           | EXC-EXCF     | 125 > 530       | 2014 > 2023 | Offset 22mm | Orange | 200.062.003-22*  | € 488,90 |
|           | SX / SXF     | 125 > 530       | 2013-2014   | Offset 22mm | Orange | 200.062.003-24*  | € 488,90 |
|           | EXC / EXCF   | 125 > 530       | 2014        | Offset 24mm | Orange | 200.062.003-24*  | € 488,90 |
| HUSQVARNA | TE / FE      | 125 > 501       | 2015 > 2023 | Offset 20mm | Blue   | 200.062.002-20   | € 488,90 |
|           | TE / FE      | 125 > 501       | 2015 > 2023 | Offset 22mm | Blue   | 200.062.002-22   | € 488,90 |
|           | TC / FC      | 125 > 450       | 2014 > 2022 | Offset 20mm | Blue   | 200.062.002-20   | € 488,90 |
|           | TC / FC      | 125 > 450       | 2023        | Offset 20mm | Blue   | 200.062A.002-22  | € 488,90 |
|           | TC / FC / FX | 125 > 450       | 2015 > 2023 | Offset 20mm | Blue   | 200.062.002-22   | € 488,90 |
| GAS GAS   | EC / ECF     | 125 > 450       | 2021 > 2023 | Offset 22mm | Red    | 200.062.004-22   | € 488,90 |
|           | MC / MCF     | 125 > 450       | 2021 > 2023 | Offset 22mm | Red    | 200.062.004-22   | € 488,90 |
| BETA      | RR           | 250 > 500       | 2012 > 2023 | Offset 20mm | Red    | 750.062.004-20   | € 488,90 |
|           | RR           | 350 > 500       | 2020 > 2023 | Offset 22mm | Red    | 750.062.004-22   | € 488,90 |
| SHERCO    | SE / SEF     | 250 > 450       | 2012 > 2021 | Offset std  | Blue   | 700.062.002      | € 488,90 |
| FANTIC    | XEF          | 250             | 2021 > 2023 | Offset std  | Red    | 300.062.004      | € 488,90 |
|           | XX - XE      | 125 2t - 250 2t | 2019 > 2023 | Offset std  | Red    | 300.062A.004     | € 488,90 |

\* suitable also for models from 2003 to 2012 mounting 2013 mudguard  
\* adatta anche ai modelli dal 2003 al 2012 montando il parafrangente SXF 2013



**WORLD  
TITLES**



## GECO HANDLEBAR SUPPORT / SUPPORTI MANUBRIO

Handlebar support diameter 28 mm Ergal 7075 T6 entirely from billet. Available in three versions with different heights from the center of the handlebar to the base plate 30, 35 or 40mm.



Supporto per manubrio diametro 28 mm in ergal interamente ricavato dal pieno.

Disponibile in tre differenti versioni con altezze dal centro manubrio a base di appoggio di 30, 35 o 40mm.

| BRAND            | MODEL         | ENGINE    | YEAR        | OFFSET                                  | COLOR  | CODE                | PRICE   |
|------------------|---------------|-----------|-------------|---|--------|---------------------|---------|
| REPLICA HONDA    | CR / CRF      | 250-450   | 2000 > 2023 | Heigh 30mm - also for Geco triple clamp | Red    | <b>100.030.028</b>  | € 97,90 |
|                  |               |           |             | Heigh 35mm - also for Geco triple clamp |        | <b>100.035.028</b>  | € 97,90 |
|                  |               |           |             | Heigh 40mm - also for Geco triple clamp |        | <b>100.040.028</b>  | € 97,90 |
| REPLICA YAMAHA   | YZF           | 250-450   | 2014 > 2023 | Heigh 30mm                              | Blue   | <b>300.030.028</b>  | € 97,90 |
|                  |               |           |             | Heigh 35mm                              |        | <b>300.035.028</b>  | € 97,90 |
|                  |               |           |             | Heigh 40mm                              |        | <b>300.040.028</b>  | € 97,90 |
| REPLICA KAWASAKI | KXF           | 250-450   | 2009 > 2023 | Heigh 30mm                              | Green  | <b>500.030.028</b>  | € 97,90 |
|                  |               |           |             | Heigh 35mm                              |        | <b>500.035.028</b>  | € 97,90 |
|                  |               |           |             | Heigh 40mm                              |        | <b>500.040.028</b>  | € 97,90 |
| REPLICA SUZUKI   | RMZ           | 250       | 2007 > 2023 | Heigh 30mm                              | Red    | <b>400.030.028</b>  | € 97,90 |
|                  |               |           |             | Heigh 35mm                              |        | <b>400.035.028</b>  | € 97,90 |
|                  |               |           |             | Heigh 40mm                              |        | <b>400.040.028</b>  | € 97,90 |
| REPLICA SUZUKI   | RMZ           | 450       | 2005 > 2023 | Heigh 30mm                              | Red    | <b>400.030.028</b>  | € 97,90 |
|                  |               |           |             | Heigh 35mm                              |        | <b>400.035.028</b>  | € 97,90 |
|                  |               |           |             | Heigh 40mm                              |        | <b>400.040.028</b>  | € 97,90 |
| REPLICA KTM      | SX/SXF        | 125 > 530 | 2000 > 2015 | Heigh 30mm                              | Orange | <b>200.030.028</b>  | € 97,90 |
|                  |               |           |             | Heigh 35mm                              |        | <b>200.035.028</b>  | € 97,90 |
|                  |               |           |             | Heigh 40mm                              |        | <b>200.040.028</b>  | € 97,90 |
| REPLICA KTM      | SX/SXF        | 125 > 530 | 2016 > 2023 | Heigh 30mm                              | Orange | <b>200A.030.028</b> | € 97,90 |
|                  |               |           |             | Heigh 35mm                              |        | <b>200A.035.028</b> | € 97,90 |
|                  |               |           |             | Heigh 40mm                              |        | <b>200A.040.028</b> | € 97,90 |
| REPLICA KTM      | EXC/EXCF/XC-W | 125 > 500 | 2000 > 2023 | Heigh 30mm                              | Orange | <b>200.030.028</b>  | € 97,90 |
|                  |               |           |             | Heigh 35mm                              |        | <b>200.035.028</b>  | € 97,90 |
|                  |               |           |             | Heigh 40mm                              |        | <b>200.040.028</b>  | € 97,90 |
| HUSQVARNA        | TC/FC         | 125 > 501 | 2014 > 2015 | Heigh 30mm                              | Blue   | <b>800.030.028</b>  | € 97,90 |
|                  |               |           |             | Heigh 35mm                              |        | <b>800.035.028</b>  | € 97,90 |
|                  |               |           |             | Heigh 40mm                              |        | <b>800.040.028</b>  | € 97,90 |
| HUSQVARNA        | TC/FC         | 125 > 450 | 2016 > 2023 | Heigh 30mm                              | Blue   | <b>800A.030.028</b> | € 97,90 |
|                  |               |           |             | Heigh 35mm                              |        | <b>800A.035.028</b> | € 97,90 |
|                  |               |           |             | Heigh 40mm                              |        | <b>800A.040.028</b> | € 97,90 |
| HUSQVARNA        | TE/FE/TX      | 125 > 501 | 2014 > 2023 | Heigh 30mm                              | Blue   | <b>800.030.028</b>  | € 97,90 |
|                  |               |           |             | Heigh 35mm                              |        | <b>800.035.028</b>  | € 97,90 |
|                  |               |           |             | Heigh 40mm                              |        | <b>800.040.028</b>  | € 97,90 |
| REPLICA SHERCO   | SE/SEF        | 250 > 450 | 2012 > 2023 | Heigh 30mm                              | Blue   | <b>700.030.028</b>  | € 97,90 |
|                  |               |           |             | Heigh 35mm                              |        | <b>700.035.028</b>  | € 97,90 |
|                  |               |           |             | Heigh 40mm                              |        | <b>700.040.028</b>  | € 97,90 |
| REPLICA BETA     | RR            | 250 > 500 | 2012 > 2023 | Heigh 30mm                              | Red    | <b>750.030.028</b>  | € 97,90 |
|                  |               |           |             | Heigh 35mm                              |        | <b>750.035.028</b>  | € 97,90 |
|                  |               |           |             | Heigh 40mm                              |        | <b>750.040.028</b>  | € 97,90 |

## GECO RUBBER KILLER / BOCCOLE RIGIDE ATTACCO MANUBRIO



They stiffens the axis between handlebars and triple clamp. Set 4pz.  
Irrigidiscono il fissaggio tra manubrio e piastre di sterzo. Set di 4pz



| BRAND | MODEL  | ENGINE    | YEAR        | COLOR | CODE        | PRICE   |
|-------|--------|-----------|-------------|-------|-------------|---------|
| HONDA | CR-CRF | 125 > 250 | 2002 > 2023 | Red   | 100.056.004 | € 26,90 |
|       | CRF    | 450       | 2002 > 2023 | Red   | 100.056.004 | € 26,90 |

## GECO TRIPLE CLAMPS RING / GHIERA PIASTRA STERZO



| BRAND   | MODEL   | ENGINE    | YEAR        | COLOR | CODE        | PRICE   |
|---------|---------|-----------|-------------|-------|-------------|---------|
| HONDA   | CRF     | 250 > 450 | 2002 > 2023 | Red   | 100.055.004 | € 17,90 |
| SUZUKI  | RMZ     | 250-450   | 2010 > 2023 | Red   | 400.055.004 | € 17,90 |
| YAMAHA  | YZF     | 250-450   | 2014 > 2023 | Blue  | 300.055.002 | € 17,90 |
| GAS GAS | EC / MC | 125 > 450 | 2001 > 2015 | Red   | 600.055.004 | € 17,90 |

## GECO TRIPLE CLAMPS BOLT / DADO PIASTRA STERZO



IN ERGAL 7075 T6

| BRAND     | MODEL           | ENGINE    | YEAR        | COLOR  | CODE        | PRICE   |
|-----------|-----------------|-----------|-------------|--------|-------------|---------|
| HONDA     | CRF             | 250-450   | 2002 > 2023 | Red    | 100.041.004 | € 17,90 |
| YAMAHA    | YZ/YZF/WR       | 125 > 450 | 2016 > 2023 | Blue   | 300.041.002 | € 17,90 |
|           |                 |           |             | Red    | 300.041.004 | € 17,90 |
| SUZUKI    | RMZ             | 250       | 2007 > 2023 | Red    | 300.041.004 | € 17,90 |
|           | RMZ             | 450       | 2005 > 2023 | Red    | 300.041.004 | € 17,90 |
| KTM       | SX/SXF/EXC/EXCF | 125 > 530 | 2002 > 2023 | Black  | 200.041.001 | € 17,90 |
|           |                 |           |             | Orange | 200.041.003 | € 17,90 |
| HUSQVARNA | TC/FC/TE/FE     | 125 > 450 | 2014 > 2023 | Black  | 200.041.001 | € 17,90 |
|           |                 |           |             | Blue   | 200.041.002 | € 17,90 |
| GAS GAS   | EC / MC         | 125 > 450 | 2021        | Red    | 200.041.004 | € 17,90 |
| HUSABERG  | TE/FE           | 125 > 500 | 2008 > 2014 | Black  | 200.041.001 | € 17,90 |
|           |                 |           |             | Blue   | 200.041.002 | € 17,90 |
| SHERCO    | SE/SEF          | 250 > 450 | 2012 > 2023 | Black  | 200.041.001 | € 17,90 |
|           |                 |           |             | Blue   | 200.041.002 | € 17,90 |

## GECO 3D FOOTPEGS / PEDANE 3D

3D working  
59 mm width replaceable inox steel tips, spacer and spring included connection more stronger they don't hold the mud.



Lavorazione in 3D - Maggiorate 59 mm di larghezza  
Punte in acciaio inox sostituibili, per una maggiore durata, comprensive di bussola e molla in acciaio inox.  
Attacco più resistente del 120% - Studiate per scaricare meglio il fango

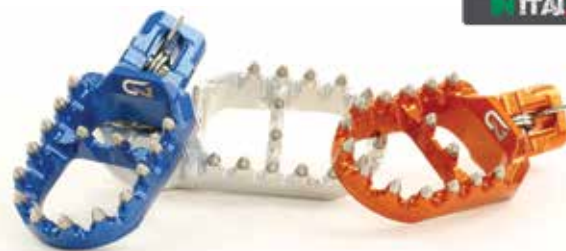

| BRAND | MODEL | ENGINE  | YEAR        | COLOR | CODE         | PRICE    |
|-------|-------|---------|-------------|-------|--------------|----------|
| HONDA | CRF   | 250-450 | 2002 > 2023 | Grey  | 100.050.000  | € 230,90 |
|       |       |         |             | Red   | 100.050.004  | € 230,90 |
|       |       |         |             | Red   | 100.050B.004 | € 230,90 |
|       |       |         |             | Black | 000.052.000  | € 31,90  |
|       | CRF   | 1000    | 2016 > 2023 | Blue  | 100.050C.002 | € 230,90 |
|       |       |         |             | Red   | 100.050C.004 | € 230,90 |

| BRAND                            | MODEL              | ENGINE      | YEAR                           | COLOR                                      | CODE         | PRICE        |          |
|----------------------------------|--------------------|-------------|--------------------------------|--|--------------|--------------|----------|
| YAMAHA                           | YZ/YZF             | 125-450     | 1997 > 2023                    | Grey                                       | 300.050.000  | € 230,90     |          |
|                                  |                    |             |                                | Blue                                       | 300.050.002  | € 230,90     |          |
|                                  |                    |             |                                | Red  | 300.050.004  | € 230,90     |          |
|                                  | WRF                | 250-450     | 2001 > 2023                    | Grey                                       | 300.050.000  | € 230,90     |          |
|                                  |                    |             |                                | Blue                                       | 300.050.002  | € 230,90     |          |
|                                  |                    |             |                                | Red  | 300.050.004  | € 230,90     |          |
| TENERE                           | 700                | 2018 > 2023 | Grey                           | 300.050.000                                | € 230,90     |              |          |
|                                  |                    |             | Blue                           | 300.050.002                                | € 230,90     |              |          |
|                                  |                    |             | Red                            | 300.050.004                                | € 230,90     |              |          |
| KAWASAKI                         | KXF                | 250-450     | 2011 > 2023                    | Green                                      | 500.050.005  | € 230,90     |          |
|                                  |                    |             |                                | Grey                                       | 500.050.000  | € 230,90     |          |
|                                  |                    |             |                                | Red  | 500.050.004  | € 230,90     |          |
| KTM                              | SX                 | 65-85       | 2008 > 2016                    | Grey                                       | 200.050.000  | € 230,90     |          |
|                                  |                    |             |                                | Orange                                     | 200.050.003  | € 230,90     |          |
|                                  |                    |             |                                | Blue                                       | 200.050.002  | € 230,90     |          |
|                                  | SX                 | 125-144-150 | 2000 > 2015                    | Grey                                       | 200.050.000  | € 230,90     |          |
|                                  |                    |             |                                | Orange                                     | 200.050.003  | € 230,90     |          |
|                                  | SX                 | 125-150     | 2016 > 2022                    | Grey                                       | 200.050A.000 | € 230,90     |          |
|                                  |                    |             |                                | Orange                                     | 200.050A.003 | € 230,90     |          |
|                                  | SX-SXF-EXC-EXCF-FC | 125 > 500   | 2017 > 2023                    | MOTARD                                     | Orange       | 200.050B.003 | € 230,90 |
|                                  |                    |             |                                | Blue                                       | 200.050B.002 | € 230,90     |          |
|                                  | SX                 | 250         | 2000 > 2016                    | Grey                                       | 200.050.000  | € 230,90     |          |
|                                  |                    |             |                                | Orange                                     | 200.050.003  | € 230,90     |          |
|                                  | SX                 | 250         | 2017 > 2022                    | Grey                                       | 200.050A.000 | € 230,90     |          |
|                                  |                    |             |                                | Orange                                     | 200.050A.003 | € 230,90     |          |
|                                  | SXF                | 250 > 505   | 2000 > 2015                    | Grey                                       | 200.050.000  | € 230,90     |          |
|                                  |                    |             |                                | Orange                                     | 200.050.003  | € 230,90     |          |
|                                  | SXF                | 250-350-450 | 2016 > 2022                    | Grey                                       | 200.050A.000 | € 230,90     |          |
|                                  |                    |             |                                | Orange                                     | 200.050A.003 | € 230,90     |          |
|                                  | SX / SXF           | 125-450     | 2023                           | Grey                                       | 200.050C.000 | € 230,90     |          |
| Orange                           |                    |             |                                | 200.050C.003                               | € 230,90     |              |          |
| EXC / EXCF                       | 125 > 530          | 2000 > 2016 | Grey                           | 200.050.000                                | € 230,90     |              |          |
|                                  |                    |             | Orange                         | 200.050.003                                | € 230,90     |              |          |
| EXC/EXCF/XC-W                    | 125 > 500          | 2017 > 2023 | Grey                           | 200.050A.000                               | € 230,90     |              |          |
|                                  |                    |             | Orange                         | 200.050A.003                               | € 230,90     |              |          |
| HUSQVARNA                        | TC                 | 85          | 2014 > 2023                    | Grey                                       | 200.050.000  | € 230,90     |          |
|                                  |                    |             |                                | Blue                                       | 200.050.002  | € 230,90     |          |
|                                  | TE / TC / FE / FC  | 125 > 501   | 2014 > 2016                    | Grey                                       | 200.050.000  | € 230,90     |          |
|                                  |                    |             |                                | Blue                                       | 200.050.002  | € 230,90     |          |
|                                  | TC / FC            | 65 > 501    | 2017 > 2022                    | Blue                                       | 200.050A.002 | € 230,90     |          |
|                                  |                    |             |                                | Blue                                       | 200.050C.002 | € 230,90     |          |
|                                  | FE / TE / TX       | 125 > 501   | 2017 > 2023                    | Grey                                       | 200.050C.000 | € 230,90     |          |
|                                  |                    |             |                                | Blue                                       | 200.050A.002 | € 230,90     |          |
|                                  | SM / SMR           | 125 > 450   | 2017 > 2023                    | MOTARD                                     | Blue         | 850.050B.002 | € 230,90 |
|                                  |                    |             |                                | Red  | 300.050.004  | € 230,90     |          |
| GASGAS                           | EC / MC            | 125 > 450   | 2001 > 2017                    | Red  | 300.050.004  | € 230,90     |          |
|                                  |                    |             |                                | Grey                                       | 200.050.000  | € 230,90     |          |
| MC/MCF/EC/ECF                    | 125 > 450          | 2021 > 2023 | Grey                           | 200.050.000                                | € 230,90     |              |          |
|                                  |                    |             | Red                            | 200.050A.004                               | € 230,90     |              |          |
| MC/MCF/EC/ECF                    | 65 > 450           | 2021 > 2023 | Red                            | 200.050A.004                               | € 230,90     |              |          |
|                                  |                    |             | Grey                           | 200.050.000                                | € 230,90     |              |          |
| HUSABERG                         | FE / TE            | 125 > 500   | 2008 > 2013                    | Grey                                       | 200.050.000  | € 230,90     |          |
|                                  |                    |             |                                | Blue                                       | 200.050.002  | € 230,90     |          |
| BETA                             | RR                 | 250 > 500   | 2005 > 2019                    | Grey                                       | 200.050.000  | € 230,90     |          |
|                                  |                    |             |                                | Red  | 200.050.004  | € 230,90     |          |
| SHERCO                           | SE / SEF           | 125 > 500   | 2013 > 2023                    | Grey                                       | 200.050.000  | € 230,90     |          |
|                                  |                    |             |                                | Blue                                       | 200.050.002  | € 230,90     |          |
| FANTIC                           | TF / TZ            | 125 > 300   | 2011 > 2014                    | Grey                                       | 300.050.000  | € 230,90     |          |
|                                  |                    |             |                                | Blue                                       | 300.050.002  | € 230,90     |          |
|                                  | XX / XEF           | 125 > 250   | 2019 > 2023                    | Grey                                       | 300.050.000  | € 230,90     |          |
|                                  |                    |             |                                | Blue                                       | 300.050.002  | € 230,90     |          |
| TM                               | MX / EN            | 125 > 500   | 2018-2019                      | Red  | 300.050.004  | € 230,90     |          |
|                                  |                    |             |                                | Grey                                       | 200.050.000  | € 230,90     |          |
| UNIVERSAL<br>PIASTRINE ANTIFANGO |                    |             |                                | Replacement steel tips and spring - 20 pcs | Grey         | 000.051.000  | € 31,90  |
|                                  |                    |             |                                | Only for Yamaha-Honda-Kawasaki             | Grey         | 100.053.000  | € 13,90  |
|                                  |                    |             | Only for Yamaha-Honda-Kawasaki | Grey                                       | 100.041.000  | € 13,90      |          |

Motard 3D footpegs with protective slider



## GECO REAR HUB RING / GHIERA MOZZO POSTERIORE

Ring made in steel as replacement of the original one more delicate made in aluminum.  
*Ghiera in acciaio in sostituzione dell'originale più delicata in alluminio*



| BRAND | MODEL | ENGINE  | YEAR        | CODE        | PRICE   |
|-------|-------|---------|-------------|-------------|---------|
| HONDA | CRF   | 250-450 | 2002 > 2023 | 100.046.000 | € 18,90 |

## GECO WHEELS AXLE BOLT / COPPIA DADI PERNI RUOTA



Made in 7075 t6 ergal. Same strenght as steel with 50% weight less

*Coppia dadi per perno ruota anteriore e posteriore in ergal 7075 T6. Hanno la stessa resistenza dell'acciaio con il 50% di peso in meno. Con anello in nylon autobloccante.*  
*Le versioni Ktm, Beta, Sherco ed Husqvarna hanno il dado cieco.*



| BRAND     | MODEL      | ENGINE    | YEAR        | COLOR  | CODE         | PRICE   |
|-----------|------------|-----------|-------------|--------|--------------|---------|
| HONDA     | CRF        | 250-450   | 2002 > 2023 | Red    | 100.005.004  | € 32,90 |
| YAMAHA    | WR-F       | 250-450   | 2011 > 2023 | Blue   | 300.005.002  | € 32,90 |
|           | YZ / WR    | 125-250   | 2016 > 2023 | Blue   | 300.005.002  | € 32,90 |
|           | YZF        | 250-450   | 2016 > 2023 | Blue   | 300.005A.002 | € 32,90 |
| KAWASAKI  | KXF        | 250-450   | 2011 > 2023 | Green  | 400.005.005  | € 32,90 |
| SUZUKI    | RMZ        | 250-450   | 2010 > 2023 | Red    | 400.005.004  | € 32,90 |
| KTM       | SX / SXF   | 125 > 505 | 2008 > 2012 | Orange | 200.005.003  | € 32,90 |
|           | EXC / EXCF | 125 > 530 | 2008 > 2015 | Orange | 200.005.003  | € 32,90 |
|           | SX / SXF   | 125 > 450 | 2013 > 2014 | Orange | 200.005A.003 | € 32,90 |
|           | SX / SXF   | 125 > 450 | 2015 > 2022 | Orange | 200.005C.003 | € 32,90 |
|           | SX / SXF   | 125 > 450 | 2023        | Orange | 200.005D.003 | € 32,90 |
|           | EXC / EXCF | 125 > 530 | 2016 > 2023 | Orange | 200.005B.003 | € 32,90 |
| HUSQVARNA | TE / FE    | 125 > 501 | 2014-2015   | Blue   | 200.005.002  | € 32,90 |
|           | TE / FE    | 125 > 500 | 2016 > 2023 | Blue   | 200.005B.002 | € 32,90 |
|           | TC / FC    | 125 > 450 | 2014        | Blue   | 800.005A.002 | € 32,90 |
|           | TC / FC    | 125 > 450 | 2016 > 2021 | Blue   | 200.005C.002 | € 32,90 |
|           | TC / FC    | 125 > 450 | 2023        | Blue   | 200.005D.002 | € 32,90 |
| HUSABERG  | TE / FE    | 125 > 501 | 2013-2014   | Blue   | 200.005.002  | € 32,90 |
| GAS-GAS   | EC / MC    | 125 > 450 | 2010 > 2019 | Red    | 600.005.004  | € 32,90 |
|           | EC / ECF   | 125 > 450 | 2021 > 2023 | Red    | 200.005B.004 | € 32,90 |
|           | MC / MCF   | 125 > 450 | 2021 > 2023 | Red    | 200.005C.004 | € 32,90 |
| BETA      | RR         | 250 > 500 | 2011 > 2023 | Red    | 750.005.004  | € 32,90 |
| SHERCO    | SE / SEF   | 250 > 450 | 2012 > 2023 | Blue   | 700.005.002  | € 32,90 |
| FANTIC    | XX         | 125 2t    | 2019 > 2023 | Red    | 300.005.004  | € 32,90 |
|           | XEF        | 250 4t    | 2021        | Red    | 300.005A.004 | € 32,90 |
| TM        | EN / SMR   | 125 2t    | 2016 > 2023 | Blue   | 850.005.002  | € 32,90 |



It makes it possible to extract the wheel axle easily and quickly without loss of time.  
*Permette di estrarre il perno della ruota in modo semplice e rapido.*

**FRONT WHEEL AXLE PULL - ESTRATTORE PERNO RUOTA ANTERIORE**

| BRAND     | MODEL           | ENGINE    | YEAR        | NOTE | COLOR  | CODE         | PRICE   |
|-----------|-----------------|-----------|-------------|------|--------|--------------|---------|
| HONDA     | CRF             | 250-450   | 2002 > 2023 |      | Red    | 100.001.004  | € 46,90 |
| YAMAHA    | WRF             | 450       | 2013 > 2023 |      | Blue   | 300.001.002  | € 46,90 |
|           | WRF             | 250       | 2015 > 2023 |      | Blue   | 300.001.002  | € 46,90 |
|           | YZ / WR         | 125-250   | 2016 > 2023 |      | Blue   | 300.001.002  | € 46,90 |
| KAWASAKI  | KXF             | 250 > 450 | 2015 > 2023 |      | Green  | 100.001.005  | € 46,90 |
| KTM       | SX / SXF        | 125 > 530 | 2002 > 2013 |      | Orange | 200.001.003  | € 46,90 |
|           | EXC-EXCF        | 125 > 530 | 2002 > 2015 |      | Orange | 200.001.003  | € 46,90 |
|           | SX/SXF/EXC/EXCF | 125 > 505 | 2016 > 2019 |      | Orange | 200.001A.003 | € 46,90 |
| HUSQVARNA | TC/TE/CR/WR     | 125 > 510 | 2008 > 2013 |      | Red    | 800.001.004  | € 46,90 |
|           | TE/FE           | 125 > 501 | 2014-2015   |      | Blue   | 200.001.002  | € 46,90 |
|           | TC/FC/TE/FE     | 125 > 500 | 2016 > 2023 |      | Blue   | 200.001A.002 | € 46,90 |
| GAS GAS   | EC / MC         | 125 > 450 | 2021 > 2023 |      | Red    | 200.001A.004 | € 46,90 |
| HUSABERG  | TE/FE           | 125 > 500 | 2013-2014   |      | Blue   | 200.001.002  | € 46,90 |
| BETA      | RR              | 250 > 500 | 2012 > 2023 |      | Red    | 750.001.004  | € 46,90 |
| SHERCO    | SE/SEF          | 250 > 450 | 2012 > 2023 |      | Blue   | 700.001.002  | € 46,90 |
| TM        | MX/EN           | 125 > 500 | 2011 > 2023 |      | Blue   | 850.001.002  | € 46,90 |
| FANTIC    | XX / XE / XEF   | 125 > 250 | 2019 > 2023 |      | Red    | 300.001.004  | € 46,90 |

**REAR WHEEL AXLE PULL - ESTRATTORE PERNO RUOTA POSTERIORE**

| BRAND     | MODEL         | ENGINE    | YEAR        | NOTE                             | COLOR  | CODE        | PRICE   |
|-----------|---------------|-----------|-------------|----------------------------------|--------|-------------|---------|
| HONDA     | CRF           | 250-450   | 2002 > 2023 |                                  | Red    | 100.002.004 | € 46,90 |
| YAMAHA    | WRF           | 450       | 2012 > 2023 |                                  | Blue   | 300.002.002 | € 46,90 |
|           | WRF           | 250       | 2015 > 2023 |                                  | Blue   | 300.002.002 | € 46,90 |
|           | YZ            | 125-250   | 2016 > 2023 |                                  | Blue   | 300.002.002 | € 46,90 |
| KAWASAKI  | KXF           | 250 > 450 | 2015 > 2023 |                                  | Green  | 100.002.005 | € 46,90 |
| KTM       | SX/SXF        | 125 > 505 | 2005 > 2012 |                                  | Orange | 200.002.003 | € 46,90 |
|           | EXC/EXCF      | 125 > 450 | 2005 > 2012 |                                  | Orange | 200.002.003 | € 46,90 |
| HUSQVARNA | TC/TE/CR/WR   | 125 > 510 | 2008 > 2013 |                                  | Red    | 800.002.004 | € 46,90 |
|           | TE/FE         | 125 > 500 | 2014 > 2023 |                                  | Blue   | 200.002.002 | € 46,90 |
| GAS GAS   | EC            | 125 > 450 | 2021 > 2023 |                                  | Red    | 200.002.004 | € 46,90 |
| HUSABERG  | TE/FE         | 125 > 500 | 2008 > 2014 |                                  | Blue   | 200.002.002 | € 46,90 |
| BETA      | RR            | 250 > 500 | 2012 > 2023 |                                  | Red    | 200.002.004 | € 46,90 |
| SHERCO    | SE/SEF        | 250 > 450 | 2012 > 2023 | for 700.010.002 axle blocks only | Blue   | 700.002.002 | € 46,90 |
| TM        | MX/EN         | 125 > 500 | 2016 > 2022 |                                  | Blue   | 850.002.002 | € 46,90 |
| FANTIC    | XX / XE / XEF | 125 > 250 | 2019 > 2023 |                                  | Red    | 300.002.004 | € 46,90 |



Front racing spacers with lightered protector.

*Coppia distanziali ruota anteriore con cuffietta alleggerita WORKS REPLICA*



| BRAND  | MODEL    | ENGINE    | YEAR        | NOTE  | COLOR | CODE               | PRICE   |
|--------|----------|-----------|-------------|---|-------|--------------------|---------|
| SUZUKI | RMZ      | 250-450   | 2012 > 2023 | Front racing spacers with lightered protector | Red   | <b>400.031.004</b> | € 48,90 |
| HONDA  | CR / CRF | 125 > 450 | 2002 > 2023 | Front racing spacers with lightered protector | Red   | <b>100.031.004</b> | € 48,90 |



Front and rear anodized spacers

*Distanziali ruota anteriori e posteriore anodizzati*

**FRONT WHEEL - RUOTA ANTERIORE**

| BRAND     | MODEL         | ENGINE    | YEAR        | NOTE                        | COLOR  | CODE                | PRICE   |
|-----------|---------------|-----------|-------------|-----------------------------|--------|---------------------|---------|
| HONDA     | CR / CRF      | 125 > 450 | 2002 > 2023 |                             | Red    | <b>100.016.004</b>  | € 26,90 |
|           | CR / CRF      | 125 > 450 | 2002 > 2023 | Works with lightened bonnet | Red    | <b>100.031.004</b>  | € 48,90 |
|           | CRFX          | 250       | 2004 > 2023 |                             | Red    | <b>100.016A.004</b> | € 26,90 |
| YAMAHA    | YZF           | 250-450   | 2009 > 2023 |                             | Blue   | <b>300.016.002</b>  | € 26,90 |
|           | YZ            | 125-250   | 2016 > 2023 |                             | Blue   | <b>300.016D.002</b> | € 26,90 |
|           | WRF           | 450       | 2013 > 2023 | Works with lightened bonnet | Blue   | <b>300.016C.002</b> | € 26,90 |
|           | WRF           | 250       | 2015 > 2023 | Works with lightened bonnet | Blue   | <b>300.016C.002</b> | € 26,90 |
| KAWASAKI  | KXF           | 250-450   | 2006 > 2023 |                             | Green  | <b>500.016.005</b>  | € 26,90 |
| SUZUKI    | RMZ           | 250-450   | 2012 > 2023 | Works with lightened bonnet | Red    | <b>400.031.004</b>  | € 48,90 |
| KTM       | SX / SXF      | 125 > 450 | 2003 > 2014 |                             | Orange | <b>200.016.003</b>  | € 31,90 |
|           | SX / SXF      | 125 > 450 | 2016 > 2023 |                             | Orange | <b>200.016A.003</b> | € 26,90 |
|           | EXC / EXCF    | 125 > 530 | 2003 > 2015 |                             | Orange | <b>200.016.003</b>  | € 31,90 |
|           | EXC / EXCF    | 125 > 530 | 2016 > 2023 |                             | Orange | <b>200.016A.003</b> | € 26,90 |
| HUSQVARNA | TC / FC       | 125 > 450 | 2014        |                             | Blue   | <b>200.016.002</b>  | € 26,90 |
|           | TE / FE       | 125 > 501 | 2014-2015   |                             | Blue   | <b>200.016.002</b>  | € 26,90 |
|           | TE / FE       | 125 > 501 | 2015 > 2023 |                             | Blue   | <b>200.016A.002</b> | € 26,90 |
| GAS GAS   | EC/ECF/MC/MCF | 125 > 450 | 2021 > 2023 |                             | Red    | <b>200.016A.004</b> | € 32,90 |
| BETA      | RR            | 250 > 500 | 2012 > 2023 |                             | Red    | <b>750.016.004</b>  | € 26,90 |
| SHERCO    | SE / SEF      | 250 > 450 | 2012 > 2023 |                             | Blue   | <b>700.016.002</b>  | € 26,90 |
| TM        | MX / EN       | 125 > 500 | 2007 > 2023 |                             | Blue   | <b>850.016.002</b>  | € 26,90 |

**REAR WHEEL - RUOTA POSTERIORE**

| BRAND     | MODEL             | ENGINE    | YEAR        | NOTE                                 | COLOR  | CODE                | PRICE   |
|-----------|-------------------|-----------|-------------|--------------------------------------|--------|---------------------|---------|
| HONDA     | CR / CRF / CRFX   | 125 > 450 | 2002 > 2023 |                                      | Red    | <b>100.016B.004</b> | € 32,90 |
| YAMAHA    | YZF               | 250-450   | 2009 > 2023 |                                      | Blue   | <b>300.016B.002</b> | € 32,90 |
|           | WRF               | 250-450   | 2013 > 2023 |                                      | Blue   | <b>300.016A.002</b> | € 32,90 |
|           | YZ                | 125-250   | 2016 > 2023 |                                      | Blue   | <b>300.016A.002</b> | € 32,90 |
| KAWASAKI  | KXF               | 250-450   | 2006 > 2023 |                                      | Green  | <b>500.016B.005</b> | € 32,90 |
| SUZUKI    | RMZ               | 250-450   | 2005 > 2023 |                                      | Red    | <b>400.016.004</b>  | € 32,90 |
| KTM       | SX / SXF          | 125 > 530 | 2003 > 2012 |                                      | Orange | <b>200.016B.003</b> | € 32,90 |
|           | EXC / EXCF        | 125-530   | 2003 > 2023 |                                      | Orange | <b>200.016B.003</b> | € 32,90 |
|           | SX / SXF          | 125 > 530 | 2013 > 2022 |                                      | Orange | <b>200.016C.003</b> | € 32,90 |
|           | SX / SXF          | 125 > 450 |             | per adattare cerchi antecedenti 2023 | Orange | <b>200.016F.003</b> | € 32,90 |
| HUSQVARNA | TC / FC / FE / TE | 125 > 501 | 2014 > 2023 |                                      | Blue   | <b>200.016B.002</b> | € 32,90 |
| GAS GAS   | EC / ECF          | 125 > 350 | 2021 > 2023 |                                      | Red    | <b>200.016B.004</b> | € 32,90 |
|           | MC / MCF          | 125 > 450 | 2021 > 2023 |                                      | Red    | <b>200.016C.004</b> | € 32,90 |
| HUSABERG  | TE / FE           | 125 > 530 | 2013-2014   |                                      | Blue   | <b>200.016B.002</b> | € 32,90 |
| BETA      | RR                | 250 > 500 | 2012 > 2023 |                                      | Red    | <b>750.016B.004</b> | € 32,90 |
| SHERCO    | SE / SEF          | 250 > 450 | 2012 > 2023 |                                      | Blue   | <b>700.016B.002</b> | € 32,90 |



De-centered hole for fast positioning on wheel with two different sprockets/chain pairing  
 Con foro disassato per un veloce posizionamento della ruota e permettere differenti tiraggi catena

| BRAND            | MODEL      | ENGINE    | YEAR        | NOTE | COLOR  | CODE                | PRICE   |
|------------------|------------|-----------|-------------|------|--------|---------------------|---------|
| <b>HONDA</b>     | CRF        | 250-450   | 2002 > 2023 |      | Red    | <b>100.010.004</b>  | € 35,90 |
| <b>YAMAHA</b>    | YZ         | 125-250   | 2015 > 2023 |      | Blue   | <b>300.010B.002</b> | € 35,90 |
|                  | YZF        | 250-450   | 2014 > 2023 |      | Blue   | <b>300.010.002</b>  | € 35,90 |
|                  | WRF        | 250-450   | 2015 > 2023 |      | Blue   | <b>300.010B.002</b> | € 35,90 |
| <b>KAWASAKI</b>  | KX / KXF   | 125 > 450 | 2005 > 2023 |      | Green  | <b>500.010.005</b>  | € 35,90 |
| <b>SUZUKI</b>    | RMZ        | 250       | 2007 > 2023 |      | Red    | <b>400.010.004</b>  | € 35,90 |
|                  | RMZ        | 450       | 2005 > 2023 |      | Red    | <b>400.010.004</b>  | € 35,90 |
| <b>KTM</b>       | SX / SXF   | 125 > 505 | 2005 > 2012 |      | Orange | <b>200.010.003</b>  | € 35,90 |
|                  | SX / SXF   | 125 > 450 | 2013 > 2022 |      | Orange | <b>200.010A.003</b> | € 35,90 |
|                  | SX / SXF   | 125 > 450 | 2023        |      | Orange | <b>200.010B.003</b> | € 35,90 |
|                  | EXC / EXCF | 125 > 530 | 2005 > 2023 |      | Orange | <b>200.010.003</b>  | € 35,90 |
| <b>HUSQVARNA</b> | FE / TE    | 125 > 501 | 2014 > 2023 |      | Blue   | <b>200.010.002</b>  | € 35,90 |
|                  | TC / FC    | 125 > 450 | 2014 > 2015 |      | Blue   | <b>200.010.002</b>  | € 35,90 |
|                  | TC         | 125 > 450 | 2013 > 2022 |      | Blue   | <b>200.010A.002</b> | € 35,90 |
|                  | TC / FC    | 125 > 450 | 2023        |      | Blue   | <b>200.010B.002</b> | € 35,90 |
| <b>GAS GAS</b>   | EC / ECF   | 125 > 350 | 2021 > 2023 |      | Red    | <b>200.010.004</b>  | € 35,90 |
|                  | MC / MCF   | 125 > 450 | 2021 > 2023 |      | Red    | <b>200.010A.004</b> | € 35,90 |
| <b>HUSABERG</b>  | TE / FE    | 125 > 450 | 2011 > 2014 |      | Blue   | <b>200.010.002</b>  | € 35,90 |
| <b>BETA</b>      | RR         | 250 > 500 | 2012 > 2023 |      | Red    | <b>750.010.004</b>  | € 35,90 |
| <b>SHERCO</b>    | SE / SEF   | 250 > 450 | 2012 > 2023 |      | Blue   | <b>700.010.002</b>  | € 35,90 |
| <b>FANTIC</b>    | XX / XEF   | 125-250   | 2019 > 2023 |      | Red    | <b>300.010B.004</b> | € 35,90 |
| <b>TM</b>        | EN / SMR   | 125 > 300 | 2018 > 2023 |      | Blue   | <b>850.010.002</b>  | € 35,90 |



Motard axle block.  
 Plastic dumper to protect swingarm.  
 Registro tendicatena per motard.  
 Tampone in plastica per salvare il forcellone da eventuali cadute.



| BRAND        | MODEL    | ENGINE    | YEAR        | NOTE  | COLOR | CODE                | PRICE   |
|--------------|----------|-----------|-------------|---|-------|---------------------|---------|
| <b>HONDA</b> | CRF      | 250-450   | 2002 > 2023 | Motard axle block with plastic dumper to protect swingarm | Red   | <b>100.014.004</b>  | € 53,90 |
| <b>TM</b>    | EN / SMR | 125 > 300 | 2018 > 2023 | MOTARD  | Blue  | <b>850.014B.002</b> | € 53,90 |
|              | SMR      | 4T        | 2018 > 2023 | MOTARD  | Blue  | <b>850.014.002</b>  | € 53,90 |



It holds the rear brake caliper in position for a quick wheel replacement. A "must have" for enduro racers.  
*Sostiene la pinza freno posteriore evitando che cada nei cambi gomme. Comprensiva di registro.*

| BRAND   | MODEL    | ENGINE    | YEAR        | NOTES                 | COLOR | CODE                | PRICE   |
|---------|----------|-----------|-------------|-----------------------|-------|---------------------|---------|
| HONDA   | CRF      | 250-450   | 2002 > 2023 |                       | Red   | <b>100.022.004</b>  | € 51,90 |
| YAMAHA  | WRF      | 250-450   | 2015 > 2023 |                       | Blue  | <b>300.022B.002</b> | € 51,90 |
|         | YZ       | 125-250   | 2016 > 2023 |                       | Blue  | <b>300.022B.002</b> | € 51,90 |
|         | YZF      | 250-450   | 2016 > 2023 |                       | Blue  | <b>300.022.002</b>  | € 51,90 |
| SUZUKI  | RMZ      | 250-450   | 2011 > 2017 |                       | Red   | <b>400.022.004</b>  | € 51,90 |
| GAS-GAS | EC / MC  | 125 > 450 | 2010 > 2017 | ONLY WITH 600.011.000 | Red   | <b>600.022.004</b>  | € 51,90 |
| BETA    | RR       | 250 > 500 | 2014 > 2023 | ONLY WITH 750.011.004 | Red   | <b>750.022.004</b>  | € 51,90 |
| FANTIC  | XX / XEF | 125-250   | 2019 > 2023 |                       | Red   | <b>300.022B.004</b> | € 51,90 |



## GECO HUB-SPROCKET LANGE / FLANGIA MOZZO-CORONA



Flange to adapt old model rear wheels to new CRF 450 2013/2014 and CRF 250 2014 models. With double centering hub sprocket.



*Flangia per adattare i vecchi cerchi posteriori ai nuovi modelli CRF 450 2013/2014 e CRF 250 2014. Con doppio centraggio mozzo corona*

| BRAND | MODEL | ENGINE | YEAR        | COLOR             | CODE               | PRICE   |
|-------|-------|--------|-------------|-------------------|--------------------|---------|
| HONDA | CRF   | 250    | 2014 > 2023 | Anodized aluminum | <b>100.067.000</b> | € 37,90 |
|       | CRF   | 450    | 2013 > 2023 | Anodized aluminum | <b>100.067.000</b> | € 37,90 |

## GECO M8 SET RING LOCK SPACER + NUT / DADO E RONDELLA FERMA COPERTONE M8



M8 nut and ring lock spacer to hold the tire

*Dado M8 e rondella per fissare il fermacopertone. Rondella sagomata per adattarsi al canale del cerchio*

| BRAND     | DESCRIPTION                                  | COLOR  | CODE               | PRICE   |
|-----------|--|--------|--------------------|---------|
| UNIVERSAL | M8 nut and ring lock spacer to hold the tire | Blue   | <b>000.001.002</b> | € 10,90 |
| UNIVERSAL | M8 nut and ring lock spacer to hold the tire | Orange | <b>000.001.003</b> | € 10,90 |
| UNIVERSAL | M8 nut and ring lock spacer to hold the tire | Red    | <b>000.001.004</b> | € 10,90 |
| UNIVERSAL | M8 nut and ring lock spacer to hold the tire | Green  | <b>000.001.005</b> | € 10,90 |

## GECO SWING ARM GUARD / SLIDER FORCELLONE



It joins chain guide supports in order to make them stronger possibility to screw it to the swing arm improving its resistance.

*Unisce i supporti del passacatena rendendoli più robusti. Possibilità di avitarlo al forcellone aumentando ancora di più la resistenza.*

| BRAND     | MODEL               | ENGINE    | YEAR        | COLOR             | CODE                | PRICE   |
|-----------|---------------------|-----------|-------------|-------------------|---------------------|---------|
| HONDA     | CRF                 | 250       | 2007 > 2013 | Anodized aluminum | <b>100.038.000</b>  | € 91,90 |
|           |                     |           | 2014 > 2023 | Anodized aluminum | <b>100.038A.000</b> | € 91,90 |
|           | CRF                 | 450       | 2007 > 2012 | Anodized aluminum | <b>100.038.000</b>  | € 91,90 |
|           |                     |           | 2013 > 2023 | Anodized aluminum | <b>100.038A.000</b> | € 91,90 |
| KTM       | SX / SXF            | 125 > 500 | 2012 > 2022 | Anodized aluminum | <b>200.038.000</b>  | € 91,90 |
|           | EXC / EXCF          | 125 > 500 | 2012 > 2023 | Anodized aluminum | <b>200.038.000</b>  | € 91,90 |
| HUSQVARNA | TC / FC / FE / TE   | 125 > 501 | 2014 > 2023 | Anodized aluminum | <b>200.038.000</b>  | € 91,90 |
| GAS GAS   | MC / MCF / EC / ECF | 125 > 450 | 2021 > 2023 | Anodized aluminum | <b>200.038.000</b>  | € 91,90 |
| SHERCO    | SE / SEF            | 250 > 450 | 2013 > 2023 | Anodized aluminum | <b>200.038.000</b>  | € 91,90 |

## GECO REAR BRAKE CLAVIS / TIRANTE FRENO POSTERIORE



| BRAND    | MODEL    | ENGINE    | YEAR        | COLOR | CODE         | PRICE   |
|----------|----------|-----------|-------------|-------|--------------|---------|
| HONDA    | CR / CRF | 125 > 450 | 2000 > 2023 | Red   | 000.012.004  | € 26,90 |
| YAMAHA   | YZ / YZF | 125 > 450 | 2000 > 2023 | Blue  | 000.012.002  | € 26,90 |
|          |          |           |             | Red   | 000.012.004  | € 26,90 |
| KAWASAKI | KX       | 125-250   | 2000 > 2007 | Red   | 000A.012.004 | € 26,90 |
|          | KXF      | 250-450   | 2004 > 2023 | Red   | 000A.012.004 | € 26,90 |
| SUZUKI   | RMZ      | 250       | 2004 > 2006 | Red   | 000A.012.004 | € 26,90 |
|          | RMZ      | 250-450   | 2007 > 2017 | Blue  | 000.012.002  | € 26,90 |
|          |          |           |             | Red   | 000.012.004  | € 26,90 |
| GAS-GAS  | EC / MC  | 125 > 450 | 2000 > 2019 | Red   | 000B.012.004 | € 26,90 |
| SHERCO   | SE / SEF | 250 > 450 | 2013 > 2023 | Blue  | 000C.012.002 | € 26,90 |
| BETA     | RR       | 250 > 500 | 2005 > 2023 | Red   | 000A.012.004 | € 26,90 |
| FANTIC   | XX / XEF | 125-250   | 2019 > 2023 | Red   | 000.012.004  | € 26,90 |



## GECO FIXATION BOLTS SET FOR BRAKE PADS KIT PERNI PASTIGLIE FRENO



Front and rear bolt made in stainless steel, hex head 8mm

*Perno anteriore e posteriore in acciaio inox, testa esagonale 8mm*

| BRAND  | MODEL          | ENGINE    | YEAR        | COLOR | CODE        | PRICE   |
|--------|----------------|-----------|-------------|-------|-------------|---------|
| HONDA  | CRF            | 250-450   | 2002 > 2023 | Inox  | 100.013.000 | € 16,90 |
| YAMAHA | YZ / YZF / WRF | 250 > 450 | 2003 > 2023 | Inox  | 100.013.000 | € 16,90 |
| BETA   | RR             | 250 > 500 | 2012 > 2023 | Inox  | 750.013.000 | € 16,90 |
| FANTIC | XX / XEF       | 125-250   | 2019 > 2023 | Inox  | 750.013.000 | € 16,90 |

## GECO SAFETY CABLE AND PLATE FOR REAR BRAKE PIASTRINA E CAVO SICUREZZA FRENO



Safety steel cable and plate for rear brake pedal fixing hole diam. 10,5 mm, hole distance 16mm

*Cavetto e piastrina di sicurezza per il freno posteriore. Foro di fissaggio diam. 10,5 mm, interasse fori 16 mm*

| BRAND | CODE        | PRICE  |
|-------|-------------|--------|
| All   | 000.043.000 | € 9,90 |



**FRONT BRAKE - CLUTCH - COPERCHI POMPA FRENO ANTERIORE E FRIZIONE IDRAULICA**

| BRAND     | MODEL           | ENGINE    | YEAR        | NOTES   | COLOR  | CODE         | PRICE   |
|-----------|-----------------|-----------|-------------|---|--------|--------------|---------|
| HONDA     | CR / CRF        | 125 > 450 | 2000 > 2023 | Nissin brake pump   | Red    | 100.042.004  | € 26,90 |
|           | CRF             | 450       | 2021 > 2023 | Nissin clutch pump  | Red    | 100.042A.004 | € 26,90 |
| YAMAHA    | YZF / WRF       | 250-450   | 2016 > 2023 | Nissin brake pump   | Blue   | 400.042.002  | € 26,90 |
| KAWASAKI  | KX / KXF        | 125 > 450 | 2004 > 2023 | Nissin brake pump   | Red    | 400.042.004  | € 26,90 |
|           |                 |           |             | Nissin brake pump   | Green  | 400.042.005  | € 26,90 |
| SUZUKI    | RM / RMZ        | 125 > 450 | 2004 > 2023 | Nissin brake pump   | Red    | 400.042.004  | € 26,90 |
|           |                 |           |             | Nissin brake pump   | Yellow | 400.042.006  | € 26,90 |
|           |                 |           |             | Nissin brake pump   | Green  | 400.042.005  | € 26,90 |
| KTM       | SX/SXF/EXC/EXCF | 125 > 530 | 2000 > 2023 | Brembo brake and clutch pump  | Orange | 200.042.003  | € 26,90 |
| HUSQVARNA | TE/TC/CR/WR     | 125 > 510 | 2008 > 2013 | Brembo brake and clutch pump  | Blue   | 200.042.002  | € 26,90 |
|           | TE/TC/FE/FC     | 125 > 501 | 2014 > 2017 | Brembo brake and clutch pump (No Husqvarna Tc-Fc 2016)                        | Blue   | 200.042.002  | € 26,90 |
|           | TE/TC/CR/WR     | 125 > 510 | 2008 > 2013 | Brembo brake and clutch pump (No Husqvarna Tc-Fc 2016)                        | Red    | 200.042.004  | € 26,90 |
|           | TE/TC/FE/FC     | 125 > 501 | 2014 > 2017 | Brembo brake and clutch pump (No Husqvarna Tc-Fc 2016)                        | Red    | 200.042.004  | € 26,90 |
| HUSABERG  | TE/FE           | 125 > 500 | 2008 > 2014 | Brembo brake and clutch pump  | Blue   | 200.042.002  | € 26,90 |
|           |                 |           |             | Brembo brake and clutch pump  | Red    | 200.042.004  | € 26,90 |
| GAS-GAS   | EC/MC           | 125 > 450 | 2000 > 2019 | Nissin brake pump   | Red    | 100.042.004  | € 26,90 |
|           |                 |           |             | Ajp brake pump  | Red    | 600.042.004  | € 26,90 |
| BETA      | MC/MCF          | 125 > 450 | 2021 > 2023 | Brembo brake and clutch pump  | Red    | 200.042.004  | € 26,90 |
|           | RR              | 250 > 500 | 2005 > 2023 | Nissin brake pump   | Red    | 100.042.004  | € 26,90 |
| SHERCO    | SE/SEF          | 125 > 500 | 2013 > 2023 | Brembo clutch pump  | Blue   | 200.042.002  | € 26,90 |
|           |                 |           |             | Brembo clutch pump  | Red    | 200.042.004  | € 26,90 |
|           |                 |           |             | Brembo brake and clutch pump  | Blue   | 200.042.002  | € 26,90 |
| TM        | MX/EN           | 125 > 500 | 2010 > 2023 | Brembo brake and clutch pump  | Red    | 200.042.004  | € 26,90 |
|           |                 |           |             | Nissin brake pump   | Blue   | 100.042.002  | € 26,90 |
| FANTIC    | XX / XEF        | 125-250   | 2019 > 2023 | Brembo clutch pump  | Blue   | 200.042.002  | € 26,90 |
|           |                 |           |             | Nissin brake pump   | Red    | 300.042.004  | € 26,90 |
| UNIVERSAL | -               | -         | -           | Magura clutch pump Hymec Serie 167 (chrome register) and Husqvarna Tc-Fc 2016 | Blue   | 000.042.002  | € 26,90 |
|           | -               | -         | -           | Magura clutch pump Hymec Serie 167 (chrome register) and Husqvarna Tc-Fc 2016 | Orange | 000.042.003  | € 26,90 |
|           | -               | -         | -           | Magura clutch pump Hymec Serie 167 (chrome register) and Husqvarna Tc-Fc 2016 | Red    | 000.042.004  | € 26,90 |

**REAR BRAKE - CLUTCH - COPERCHI POMPA FRENO POSTERIORE**

| BRAND     | MODEL           | ENGINE    | YEAR        | NOTES | COLOR  | CODE         | PRICE   |
|-----------|-----------------|-----------|-------------|-------|--------|--------------|---------|
| HONDA     | CR/CRF          | 125 > 450 | 2000 > 2023 |       | Red    | 100.042B.004 | € 26,90 |
| YAMAHA    | YZ/YZF/WRF      | 125 > 450 | 2008 > 2023 |       | Blue   | 300.042B.002 | € 26,90 |
|           |                 |           |             |       | Red    | 300.042B.004 | € 26,90 |
| KAWASAKI  | KX/KXF          | 125 > 450 | 2004 > 2023 |       | Red    | 400.042B.004 | € 26,90 |
|           |                 |           |             |       | Green  | 400.042B.005 | € 26,90 |
| SUZUKI    | RM/RMZ          | 125 > 450 | 2004 > 2023 |       | Red    | 400.042B.004 | € 26,90 |
| KTM       | SX/SXF/EXC/EXCF | 125 > 530 | 2000 > 2023 |       | Orange | 200.042B.003 | € 26,90 |
| HUSQVARNA | TC/TE/FE/FC     | 125 > 501 | 2014 > 2017 |       | Blue   | 200.042B.002 | € 26,90 |
| GAS-GAS   | MC / MCF        | 125 > 450 | 2011 > 2017 |       | Red    | 300.042B.004 | € 26,90 |
|           | MC / MCF        | 125 > 450 | 2021 > 2023 |       |        | 200.042B.004 | € 26,90 |
| HUSABERG  | TE / FE         | 125 > 450 | 2008 > 2013 |       | Blue   | 200.042B.002 | € 26,90 |
| BETA      | RR              | 250 > 500 | 2005 > 2023 |       | Blue   | 300.042B.002 | € 26,90 |
|           |                 |           |             |       | Red    | 300.042B.004 | € 26,90 |
| TM        | MX / EN         | 125 > 500 | 2007 > 2023 |       | Blue   | 300.042B.002 | € 26,90 |
| FANTIC    | XX/XEF          | 125-250   | 2019 > 2023 |       | Red    | 300.042B.004 | € 26,90 |

## GECO BAR CLAMP / SEMICOLLARINO UNIVERSALE



| BRAND     | COLOR  | CODE        | PRICE   |
|-----------|--------|-------------|---------|
| UNIVERSAL | Blue   | 000.044.002 | € 31,90 |
| UNIVERSAL | Orange | 000.044.003 | € 31,90 |
| UNIVERSAL | Red    | 000.044.004 | € 31,90 |
| UNIVERSAL | Green  | 000.044.005 | € 31,90 |
| UNIVERSAL | Yellow | 000.044.006 | € 31,90 |

Elegant design and lightness.  
Semicollarino universale interasse 32mm dal design curato e dalla estrema leggerezza e robustezza

## GECO GUIDE CLUTCH CABLE / SUPPORTO RIGIDO CAVO FRIZIONE



Stronger than the original one.  
Più rigido rispetto all'originale migliora la sensibilità al comando frizione

| BRAND | MODEL | ENGINE | YEAR        | COLOR | CODE         | PRICE   |
|-------|-------|--------|-------------|-------|--------------|---------|
| HONDA | CRF   | 250    | 2010 > 2013 | Red   | 100.049.004  | € 32,90 |
|       |       |        | 2014 > 2017 | Red   | 100.049B.004 | € 70,90 |
|       |       |        | 2018 > 2023 | Red   | 100.049.004  | € 32,90 |
|       | CRF   | 450    | 2010 > 2014 | Red   | 100.049.004  | € 32,90 |
|       |       |        | 2015-2016   | Red   | 100.049C.004 | € 70,90 |
|       |       |        | 2017 > 2023 | Red   | 100.049D.004 | € 75,90 |





It replaces oem caliper mount aluminum made to protect rear rotor from stones impact.

*Sostituisce il supporto pinza originale Completamente in alluminio dal pieno per proteggere il disco dagli urti più violenti*



| BRAND            | MODEL             | ENGINE    | YEAR        | COLOR        | CODE                | PRICE    |
|------------------|-------------------|-----------|-------------|--------------|---------------------|----------|
| <b>HONDA</b>     | CR / CRF          | 125 > 450 | 2002 > 2017 | Red-Black    | <b>100.011.004</b>  | € 215,90 |
|                  | CRF               | 250       | 2018 > 2023 | Red-Black    | <b>100.011A.004</b> | € 215,90 |
|                  | CRF               | 450       | 2017 > 2023 | Red-Black    | <b>100.011A.004</b> | € 215,90 |
| <b>KTM</b>       | SX / SXF          | 125 > 505 | 2003 > 2012 | Orange-Black | <b>200.011.003</b>  | € 215,90 |
|                  | EXC / EXCF        | 125 > 530 | 2003 > 2023 | Orange-Black | <b>200.011.003</b>  | € 215,90 |
| <b>HUSQVARNA</b> | TE / FE / TC / FC | 125 > 501 | 2014 > 2017 | Blue-Black   | <b>200.011.002</b>  | € 215,90 |
| <b>GAS-GAS</b>   | EC / MC           | 125 > 450 | 2010 > 2019 | Red-Black    | <b>600.011.004</b>  | € 215,90 |
|                  | EC / ECF          | 125 > 350 | 2021 > 2023 | Red-Black    | <b>200.011.004</b>  | € 215,90 |
| <b>HUSABERG</b>  | TE / FE           | 125 > 500 | 2008 > 2023 | Blue-Black   | <b>200.011.002</b>  | € 215,90 |
| <b>SHERCO</b>    | SE / SEF          | 250-450   | 2013 > 2023 | Blue-Black   | <b>700.011.002</b>  | € 215,90 |
| <b>BETA</b>      | RR                | 250-450   | 2015 > 2023 | Red-Black    | <b>750.011.004</b>  | € 215,90 |
| <b>FANTIC</b>    | XX / XEF          | 125-250   | 2019 > 2023 | Red-Black    | <b>300.011.004</b>  | € 215,90 |

| REPLACEMENT PARTS / RICAMBI      | COLOR  | CODE               | PRICE   |
|----------------------------------|--------|--------------------|---------|
| RICAMBIO PINNA HONDA/BETA/GASGAS | Red    | <b>000.011.004</b> | € 48,90 |
| RICAMBIO PINNA HUSQVARNA/SHERCO  | Blue   | <b>000.011.002</b> | € 48,90 |
| RICAMBIO PINNA KTM               | Orange | <b>000.011.003</b> | € 48,90 |



## GECO ERGAL SCREWS COMPLETE WITH WASHER / VITERIA IN ERGAL



Screw radiator bleed vent M12x1.25  
Vite spurgo sfiato radiatore M12x1.25  
**000.036.004**



Shrouds and side panels screws / Viti convogliatore/radiatore serbatoio e fianchetti

| BRAND     | MODEL       | ENGINE     | YEAR        | NOTES   | COLOR | CODE                | PRICE   |
|-----------|-------------|------------|-------------|---|-------|---------------------|---------|
| HONDA     | CRF         | 250        | 2002 > 2017 | Tank-shrouds-radiator-side panels screws 6pz. M6+4pz M5 | Red   | <b>100.075.004</b>  | € 53,90 |
|           | CRF         | 250        | 2018 > 2020 | Tank-shrouds-radiator-side panels screws 6pz. M6+4pz M5 | Red   | <b>100.075A.004</b> | € 53,90 |
|           | CRF         | 450        | 2002 > 2016 | Tank-shrouds-radiator-side panels screws 6pz. M6+4pz M5 | Red   | <b>100.075.004</b>  | € 53,90 |
|           | CRF         | 450        | 2017 > 2020 | Tank-shrouds-radiator-side panels screws 6pz. M6+4pz M5 | Red   | <b>100.075A.004</b> | € 53,90 |
| SUZUKI    | RMZ         | All models | 2010 > 2014 | Tank-shrouds-radiator-side panels screws 6pz. M6+4pz M5 | Red   | <b>400.023.004</b>  | € 53,90 |
|           | RMZ         | 250-450    | 2010 > 2017 | Tank-shrouds-radiator-side panels screws 6pz. M6+4pz M5 | Red   | <b>400.075.004</b>  | € 53,90 |
| KAWASAKI  | KXF         | 250-450    | 2015 > 2023 | Tank-shrouds-radiator-side panels screws 6pz. M6+4pz M5 | Green | <b>500.075.005</b>  | € 53,90 |
| HUSQVARNA | TC-TE-CR-WR | 125 > 510  | 2010 > 2013 | Shrouds-radiator-side panels screws 6pz. M6             | Red   | <b>800.023.004</b>  | € 30,90 |
| BETA      | RR          | 250 > 500  | 2005 > 2019 | Shrouds-radiator-side panels screws 6pz. M6             | Red   | <b>750.023.004</b>  | € 30,90 |
| SHERCO    | SE / SEF    | 250 > 450  | 2005 > 2023 | Tank-shrouds-radiator-side panels screws 4pz. M6+4pz M5 | Blue  | <b>700.075.002</b>  | € 53,90 |
| TM        | EN / SN     | 125 > 450  | 2018 > 2023 | Tank-shrouds-radiator-side panels screws 5pz. M6+5pz M5 | Blue  | <b>850.075.002</b>  | € 53,90 |
| UNIVERSAL | -           | -          | -           | Screw radiator bleed vent, M12X1,25                     | Red   | <b>000.036.004</b>  | € 13,90 |

## GECO SEAT SCREWS / VITI SELLA



| BRAND    | MODEL | ENGINE  | YEAR        | NOTES    | COLOR | CODE                | PRICE   |
|----------|-------|---------|-------------|----------|-------|---------------------|---------|
| HONDA    | CRF   | 250     | 2002 > 2013 | 2 pcs M8 | Red   | <b>100.028.004</b>  | € 19,90 |
|          |       |         | 2014 > 2017 | 2 pcs M8 | Red   | <b>100.028A.004</b> | € 19,90 |
|          |       |         | 2018 > 2021 | 2 pcs M8 | Red   | <b>100.028B.004</b> | € 19,90 |
|          | CRF   | 450     | 2002 > 2012 | 2 pcs M8 | Red   | <b>100.028.004</b>  | € 19,90 |
|          |       |         | 2013 > 2016 | 2 pcs M8 | Red   | <b>100.028A.004</b> | € 19,90 |
|          |       |         | 2017 > 2020 | 2 pcs M8 | Red   | <b>100.028B.004</b> | € 19,90 |
| KAWASAKI | KXF   | 250-450 | 2015 > 2023 | 2 pcs M8 | Green | <b>500.028.005</b>  | € 19,90 |
| SUZUKI   | RMZ   | 250-450 | 2010 > 2023 | 2 pcs M8 | Red   | <b>400.028.004</b>  | € 19,90 |

## GECO BRAKE HOSE HOLDER SCREWS / VITI FERMATUBO



| BRAND  | MODEL | ENGINE  | YEAR        | NOTES                             | COLOR | CODE        | PRICE   |
|--------|-------|---------|-------------|-----------------------------------|-------|-------------|---------|
| HONDA  | CRF   | 250-450 | 2002 > 2023 | Brake hose holder screws 2 pcs M6 | Red   | 100.027.004 | € 19,90 |
|        |       |         |             |                                   | Blue  | 100.027.002 | € 19,90 |
| SUZUKI | RMZ   | 250-450 | 2010 > 2023 | Brake hose holder screws 2 pcs M6 | Red   | 400.027.004 | € 19,90 |
| YAMAHA | YZF   | 250-450 | 2007 > 2023 | Brake hose holder screws 2 pcs M6 | Blue  | 100.027.002 | € 19,90 |

## GECO FORKS SHIELD SCREWS / VITI PARASTELI



| BRAND     | MODEL                        | ENGINE      | YEAR         | NOTES              | COLOR        | CODE         | PRICE   |
|-----------|------------------------------|-------------|--------------|--------------------|--------------|--------------|---------|
| HONDA     | CR / CRF                     | 125 > 450   | 2000 > 2023  | 6PZ. M6            | Blue         | 000.026.002  | € 27,90 |
|           |                              |             |              |                    | Red          | 000.026.004  | € 27,90 |
| YAMAHA    | YZ / YZF                     | 125 > 450   | 2000 > 2015  | 6PZ. M6            | Blue         | 000.026.002  | € 27,90 |
|           |                              |             |              |                    | Red          | 000.026.004  | € 27,90 |
|           |                              |             |              |                    | Green        | 000.026.005  | € 27,90 |
| KAWASAKI  | KXF                          | 250         | 2015 > -2023 | 6PZ. M6            | Green        | 000.026.005  | € 27,90 |
|           |                              | 450         | 2015         | 6PZ. M6            | Green        | 000.026.005  | € 27,90 |
|           |                              | 450         | 2016 > 2023  | 6PZ. M6            | Green        | 000.026B.005 | € 27,90 |
| SUZUKI    | RMZ                          | 250-450     | 2010 > 2017  | 6PZ. M6 - Wrench 8 | Red          | 400.026.004  | € 27,90 |
| KTM       | SX / SXF                     | 125 > 450   | 2003 > 2014  | 6PZ. M6            | Orange       | 200.026.003  | € 27,90 |
|           |                              |             |              |                    | Red          | 200.026.004  | € 27,90 |
|           | SX / SXF                     | 125 > 450   | 2015 > 2023  | 6PZ. M6            | Orange       | 200.026B.003 | € 27,90 |
|           |                              |             |              |                    | Orange       | 200.026.003  | € 27,90 |
|           | EXC / EXCF                   | 125 > 530   | 2003 > 2015  | 6PZ. M6            | Orange       | 200.026.003  | € 27,90 |
|           |                              |             |              |                    | Red          | 200.026.004  | € 27,90 |
|           |                              |             |              |                    | Orange       | 200.026B.003 | € 27,90 |
| HUSQVARNA | EXC / EXCF                   | 125 > 500   | 2016 > 2023  | 6PZ. M6            | Orange       | 200.026B.003 | € 27,90 |
|           |                              | 125 > 510   | 2008 > 2013  | 6PZ. M6            | Blue         | 800.026.004  | € 27,90 |
|           | TC / TE / CR / WR<br>TC / FC | 125 > 450   | 2014         | 6PZ. M6            | Blue         | 200.026.002  | € 27,90 |
|           |                              | Red         | 200.026.004  | € 27,90            |              |              |         |
| TE / FE   | 125 > 501                    | 2014-2015   | 6PZ. M6      | Blue               | 200.026.002  | € 27,90      |         |
|           |                              |             |              | Red                | 200.026.004  | € 27,90      |         |
|           |                              |             |              | Blue               | 200.026B.002 | € 27,90      |         |
| TC / FC   | 125 > 450                    | 2015 > 2023 | 6PZ. M6      | Blue               | 200.026B.002 | € 27,90      |         |
|           |                              |             |              | Blue               | 200.026B.002 | € 27,90      |         |
| GAS-GAS   | EC / MC                      | 125 > 450   | 2010 > 2016  | 6PZ. M6            | Red          | 600.026.004  | € 27,90 |
| HUSABERG  | TE / FE                      | 125 > 450   | 2008 > 2014  | 6PZ. M6            | Blue         | 200.026.002  | € 27,90 |
|           |                              |             |              |                    | Red          | 200.026.004  | € 27,90 |
| BETA      | RR                           | 250 > 500   | 2005 > 2023  | 6PZ. M6            | Blue         | 200.026.002  | € 27,90 |
|           |                              |             |              |                    | Red          | 200.026.004  | € 27,90 |
| SHERCO    | SE / SEF                     | 250 > 450   | 2008 > 2023  | 6PZ. M6            | Blue         | 000.026.002  | € 27,90 |
|           |                              |             |              |                    | Red          | 000.026.004  | € 27,90 |
| TM        | MX / EN                      | 125 > 450   | 2007 > 2023  | 6PZ. M6            | Blue         | 000.026.002  | € 27,90 |
|           |                              |             |              |                    | Red          | 000.026.004  | € 27,90 |

## GECO TANK - RADIATOR SPACER / BUSSOLE SERBATOIO RADIATORE



WORX tank spacer and radiator spacer complete with rear washer.

Bussole serbatoio WORX e bussole radiatore complete di rondella posteriore

| BRAND   | MODEL   | ENGINE    | YEAR        | NOTES                | COLOR | CODE               | PRICE   |
|---------|---------|-----------|-------------|----------------------|-------|--------------------|---------|
| HONDA   | CRF     | 250-450   | 2002 > 2017 | Tank spacer          | Red   | <b>100.024.004</b> | € 7,90  |
|         |         |           | 2010 > 2023 | Radiator spacer 2pz. | Red   | <b>100.035.004</b> | € 22,90 |
| SUZUKI  | RMZ     | 250-450   | 2010 > 2017 | Tank spacer          | Red   | <b>400.024.004</b> | € 7,90  |
|         |         |           | 2010 > 2017 | Radiator spacer 2pz. | Red   | <b>100.035.004</b> | € 22,90 |
|         |         |           |             | Radiator spacer 2pz. | Red   | <b>400.035.004</b> | € 22,90 |
| GAS-GAS | EC / MC | 125 > 450 | 2010 > 2015 | Radiator spacer 2pz. | Red   | <b>600.035.004</b> | € 22,90 |
| BETA    | RR      | 250 > 500 | 2013 > 2020 | Radiator spacer 2pz. | Red   | <b>750.024.004</b> | € 7,90  |

## GECO RECYCLE OIL STEAM REMOVAL FILTRO ELIMINAZIONE A 3 VIE



It remove the recycle engine oil vapors engine lasts longer racing use only plug included.

Elimina il ricircolo dei vapori olio all'interno del motore Maggiore durata del motore.

Tappo chiusura cassa filtro incluso.

| BRAND | MODEL | ENGINE  | YEAR        | COLOR | CODE               | PRICE   |
|-------|-------|---------|-------------|-------|--------------------|---------|
| HONDA | CRF   | 250-450 | 2012 > 2023 | Red   | <b>100.009.004</b> | € 26,90 |

## GECO CNC TANK CAP TAPPO SERBATOIO CNC

| BRAND  | MODEL     | ENGINE    | YEAR        | NOTES | COLOR | CODE               | PRICE   |
|--------|-----------|-----------|-------------|-------|-------|--------------------|---------|
| TM     | EN/MX/SMR | 125 > 300 | 2018 > 2023 |       | Blue  | <b>850.015.002</b> | € 53,90 |
| SHERCO | SE / SEF  | 125 > 450 | 2017 > 2023 |       | Blue  | <b>700.015.002</b> | € 53,90 |
| FANTIC | XX        | 125       | 2019 > 2023 |       | Red   | <b>700.015.004</b> | € 53,90 |



## GECO CNC OIL FILTER CAP TAPPO FILTRO OLIO CNC

| BRAND     | MODEL        | ENGINE    | YEAR        | NOTES | COLOR | CODE               | PRICE   |
|-----------|--------------|-----------|-------------|-------|-------|--------------------|---------|
| KTM       | EXC / EXCF   | 250 > 450 | 2014 > 2023 |       | Blue  | <b>200.017.002</b> | € 42,90 |
| GAS-GAS   | MC / MCF     | 250 > 450 | 2021 > 2023 |       | Red   | <b>200.017.004</b> | € 42,90 |
| HUSQVARNA | FC / FE / FS | 250 > 501 | 2017 > 2023 |       | Blue  | <b>200.017.002</b> | € 42,90 |
| YAMAHA    | YZF          | 250 > 450 | 2018 > 2023 |       | Blue  | <b>300.017.002</b> | € 42,90 |
| FANTIC    | XEF          | 250       | 2021 > 2023 |       | Red   | <b>300.017.004</b> | € 42,90 |



## GECO SHOCK LINK TRIANGLE / TRIANGOLO LEVERAGGIO



Shock link triangle  
Triangolo leveraggio con slitta protezione.  
**200.047.010**



Slider replace for 200.047.010  
Ricambio slitta per 200.047.010  
**200.047R.010**



Made in ergal 7075.  
Stronger than the original one with interchangeable plastic slide.  
Più robusto dell'originale con slittain plastica intercambiabile  
per la massima protezione dagli urti.

| BRAND     | MODEL       | ENGINE    | YEAR        | NOTES  | COLOR     | CODE                | PRICE    |
|-----------|-------------|-----------|-------------|--|-----------|---------------------|----------|
| HONDA     | CRF         | 450       | 2013 > 2016 | Shock link triangle with hard surface treatment and antishock slider | Champagne | <b>100.048.000</b>  | € 198,90 |
|           | CRF         | 450       | 2017 > 2021 | Shock link triangle with hard surface treatment and antishock slider | Champagne | <b>100.047.004</b>  | € 198,90 |
|           | CRF         | 250       | 2014 > 2017 | Shock link triangle with hard surface treatment and antishock slider | Champagne | <b>100.048.000</b>  | € 198,90 |
|           | CRF         | 250       | 2018 > 2021 | Shock link triangle with hard surface treatment and antishock slider | Champagne | <b>100.047.004</b>  | € 198,90 |
|           | CRF         | 450       | 2013 > 2016 | Shock link slider made by antishock nylon                            | Black     | <b>100.048R.000</b> | € 29,90  |
|           | CRF         | 250       | 2014 > 2017 | Shock link slider made by antishock nylon                            | Black     | <b>100.048R.000</b> | € 29,90  |
| KTM       | SX/SXF      | 125 > 450 | 2015 > 2023 | Shock link triangle with antishock slider                            | Black     | <b>200.047.010</b>  | € 377,90 |
|           | EC/ECF      | 125 > 450 | 2021 > 2023 | Shock link triangle with antishock slider                            | Black     | <b>200.047.010</b>  | € 377,90 |
| HUSQVARNA | TE/FE/TC/FC | 125 > 500 | 2014 > 2023 | Shock link triangle with antishock slider                            | Black     | <b>200.047.010</b>  | € 377,90 |
|           |             |           |             | Antishock slider replace for 200.047.010                             | Black     | <b>200.047R.010</b> | € 161,90 |

## GECO LOWER ENGINE SUPPORT / SUPPORTI MOTORE BASSI



Left and right supports supplied

*Supporto destro e sinistro*

| BRAND | MODEL | ENGINE | YEAR        | COLOR | CODE        | PRICE   |
|-------|-------|--------|-------------|-------|-------------|---------|
| HONDA | CRF   | 250    | 2010 > 2017 | Red   | 100.091.004 | € 35,90 |
|       | CRF   | 450    | 2009 > 2016 | Red   | 100.093.004 | € 35,90 |

## GECO HEAT DISSIPATOR / DISSIPATORE DI CALORE

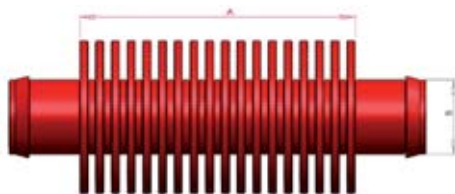

"Must have" for 4t to Reduce engine temperature

*Indispensabile nei 4T per ridurre la temperatura del motore*

| A  | B    | COLOR | CODE         | PRICE   |
|----|------|-------|--------------|---------|
| 90 | 19,5 | Red   | 100.032.004  | € 37,90 |
| 37 | 19,5 | Red   | 100.032A.004 | € 35,90 |





| BRAND            | MODEL     | ENGINE      | YEAR        | NOTES  | COLOR               | CODE                | PRICE   |
|------------------|-----------|-------------|-------------|--------|---------------------|---------------------|---------|
| <b>HONDA</b>     | CRF       | 250         | 2002 > 2009 | (3PZ.) | Red                 | <b>100.008.004</b>  | € 48,90 |
|                  | CRF       | 150-250-450 | 2004 > 2017 | (2PZ.) | Red                 | <b>100.007.004</b>  | € 37,90 |
|                  | CRF       | 450         | 2004 > 2016 | (2PZ.) | Red                 | <b>100.007.004</b>  | € 37,90 |
|                  | CRF       | 450         | 2017 > 2023 | (1PZ.) | Red                 | <b>100.007A.004</b> | € 37,90 |
| <b>YAMAHA</b>    | CRF       | 250         | 2018 > 2023 | (2PZ.) | Red                 | <b>100.007B.004</b> | € 37,90 |
|                  | YZF       | 250         | 2014 > 2023 | (2PZ.) | Blue                | <b>300.007B.002</b> | € 37,90 |
|                  | YZF       | 450         | 2010 > 2023 | (2PZ.) | Blue                | <b>300.007B.002</b> | € 37,90 |
| <b>WRF</b>       | 250-450   | 2015 > 2023 | (2PZ.)      | Blue   | <b>300.007B.002</b> | € 37,90             |         |
| <b>KAWASAKI</b>  | KXF       | 250-450     | 2011 > 2023 | (2PZ.) | Green               | <b>500.007.005</b>  | € 37,90 |
| <b>SUZUKI</b>    | RMZ       | 250         | 2007 > 2023 | (2PZ.) | Red                 | <b>400.007.004</b>  | € 37,90 |
|                  | RMZ       | 450         | 2005 > 2023 | (2PZ.) | Red                 | <b>400.007.004</b>  | € 37,90 |
| <b>SHERCO</b>    | SEF       | 250-300-450 | 2018 > 2023 |        | Blue                | <b>700.007.002</b>  | € 23,90 |
| <b>HUSQVARNA</b> | FE / TE   | 250 > 501   | 2014 > 2023 |        | Blue                | <b>200.007.002</b>  | € 23,90 |
| <b>KTM</b>       | SXF       | 250-350     | 2011 > 2023 |        | Orange              | <b>200.007.003</b>  | € 23,90 |
|                  | SXF       | 450-505     | 2007 > 2012 |        | Orange              | <b>200.007.003</b>  | € 23,90 |
|                  | EXCF      | 250 > 350   | 2012 > 2023 |        | Orange              | <b>200.007.003</b>  | € 23,90 |
|                  | SMR       | 450         | 2008 > 2012 |        | Orange              | <b>200.007.003</b>  | € 23,90 |
| <b>GAS GAS</b>   | ECF / MCF | 250 > 450   | 2021 > 2023 |        | Red                 | <b>200.007.004</b>  | € 23,90 |
| <b>TM</b>        | EN / SMR  | 250-450     | 2018 > 2023 |        | Blue                | <b>850.007.002</b>  | € 23,90 |
| <b>FANTIC</b>    | XEF       | 250         | 2021 > 2023 |        | Red                 | <b>300.007B.004</b> | € 23,90 |

**GECO** MANUAL CAMCHAIN TENSIONER / TENDICATENA DISTRIBUZIONE MANUALE



Safe and precise tensioning  
Regolazione precisa e sicura

| BRAND            | MODEL   | ENGINE  | YEAR        | NOTES | COLOR        | CODE                | PRICE   |
|------------------|---------|---------|-------------|-------|--------------|---------------------|---------|
| <b>HONDA</b>     | CRF     | 150     | 2007 > 2018 |       | Red-Black    | <b>100.040.004</b>  | € 59,90 |
|                  | CRF     | 250     | 2011 > 2017 |       | Red-Black    | <b>100.040.004</b>  | € 59,90 |
|                  | CRF     | 450     | 2009 > 2023 |       | Red-Black    | <b>100.040.004</b>  | € 59,90 |
| <b>KTM</b>       | EXCF    | 250-350 | 2007 > 2023 |       | Orange-Black | <b>200.040.003</b>  | € 52,90 |
|                  | SXF     | 250-350 | 2007 > 2023 |       | Orange-Black | <b>200.040.003</b>  | € 52,90 |
|                  | SXF     | 450     | 2007 > 2012 |       | Orange-Black | <b>200.040.003</b>  | € 52,90 |
|                  | SXF/EXC | 450     | 2012 > 2023 |       | Orange-Black | <b>200.040A.003</b> | € 59,90 |
| <b>HUSQVARNA</b> | FE/FC   | 250-350 | 2014 > 2023 |       | Blue-Black   | <b>200.040.002</b>  | € 52,90 |
|                  | FC      | 450     | 2014 > 2023 |       | Blue-Black   | <b>200.040A.002</b> | € 52,90 |
| <b>GAS GAS</b>   | ECF     | 250-350 | 2021 > 2023 |       | Red-Black    | <b>200.040.004</b>  | € 52,90 |
|                  | MCF     | 450     | 2021 > 2023 |       | Red-Black    | <b>200.040A.004</b> | € 52,90 |
| <b>HUSABERG</b>  | FE      | 250     | 2008 > 2013 |       | Blue-Black   | <b>200.040.002</b>  | € 52,90 |



It combines manual closure handles and hex shape for closure with tool.

**N.B. hex wrench is to be used only for the opening.**

*Combina la chiusura manuale tramite le alette con la apertura tramite chiave esagonale.*

**N.B. la chiave esagonale è da utilizzare esclusivamente per l'apertura non per il serraggio.**

| BRAND     | MODEL           | ENGINE          | YEAR        | NOTES         | COLOR  | CODE         | PRICE       |
|-----------|-----------------|-----------------|-------------|---------------|--------|--------------|-------------|
| HONDA     | CRF             | 250             | 2002 > 2017 |               | Red    | 100.020.004  | € 35,90     |
|           | CRF             | 450             | 2002 > 2016 |               | Red    | 100.020.004  | € 35,90     |
|           | CRF             | 250             | 2010 > 2017 | With dipstick | Red    | 100.020B.004 | € 37,90     |
|           | CRF             | 250             | 2018 > 2023 | With dipstick | Red    | 100.020C.004 | € 37,90     |
|           | CRF             | 250             | 2018 > 2023 |               | Red    | 100.020D.004 | € 37,90     |
|           | CRF             | 450             | 2009 > 2016 | With dipstick | Red    | 100.020A.004 | € 37,90     |
|           | CRF             | 450             | 2017 > 2023 | With dipstick | Red    | 100.020C.004 | € 37,90     |
|           | CRF             | 450             | 2021 > 2023 |               | Red    | 100.020D.004 | € 37,90     |
|           | YAMAHA          | YZ              | 125-250     | 2000 > 2023   |        | Blue         | 300.020.002 |
| YZF / WRF |                 | 250-450         | 2000 > 2023 |               | Blue   | 300.020.002  | € 35,90     |
| KAWASAKI  | KXF             | 250-450         | 2004 > 2023 |               | Red    | 500.020.004  | € 35,90     |
|           | KXF             | 250-450         | 2004 > 2023 |               | Green  | 500.020.005  | € 35,90     |
| SUZUKI    | RM              | 125-250         | 2000 > 2020 |               | Red    | 400.020.004  | € 35,90     |
|           | RMZ             | 250             | 2007 > 2020 |               | Red    | 400.020.004  | € 35,90     |
|           | RMZ             | 450             | 2005 > 2020 |               | Red    | 400.020.004  | € 35,90     |
| KTM       | SX/SXF/EXC/EXCF | 125 > 530       | 2003 > 2020 |               | Orange | 200.020.003  | € 35,90     |
| HUSQVARNA | TE/FE/TC/FC     | 125 > 501       | 2014 > 2020 |               | Blue   | 200.020.002  | € 35,90     |
|           |                 |                 |             |               | Red    | 200.020.004  | € 35,90     |
| HUSABERG  | TE/FE           | 125 > 500       | 2008 > 2013 |               | Blue   | 200.020.002  | € 35,90     |
|           |                 |                 |             |               | Red    | 200.020.004  | € 35,90     |
|           |                 |                 |             |               | Red    | 200.020.004  | € 35,90     |
| GAS GAS   | EC              | 125 > 300       | 2001 > 2015 |               | Red    | 600.020.004  | € 35,90     |
|           | EC/EC-F/MC/MC-F | 125 > 450       | 2021        |               | Red    | 200.020.004  | € 35,90     |
| BETA      | RR              | 250 > 500       | 2005 > 2023 |               | Blue   | 200.020.002  | € 35,90     |
|           | RR              | 125-200-250-300 | 2018 > 2023 |               | Red    | 750.020.004  | € 35,90     |
| SHERCO    | SE/SEF          | 125 > 500       | 2013 > 2023 |               | Blue   | 700.020.002  | € 35,90     |
| TM        | EN/SMR          | 125 > 450       | 2018 > 2021 |               | Blue   | 850.020.002  | € 35,90     |
| FANTIC    | XX / XEF        | 125 > 250       | 2019 > 2023 |               | Red    | 100.020.004  | € 35,90     |

**GECO** PLATE HOLDER / PORTA TARGA



| BRAND     | NOTES   | COLOR      | CODE           | PRICE   |
|-----------|---|------------|----------------|---------|
| UNIVERSAL | CNC machined plate holder made in ultraresistant plastic material             | Black      | 000.003.001    | € 26,90 |
| UNIVERSAL | CNC machined plate holder made in ultraresistant plastic material - AUSTRIACA | Black      | 000.003B.001   | € 26,90 |
| UNIVERSAL | Triangular plate  | Galvanized | 000.003.STAFFA | € 26,90 |



R-TECH

en

39

INPLAF

R-TECH

COZ COMPOSITI

FANTIE RACING

50

ME

**Albert Cabestany**  
*Team Beta Factory Trial*





Completely solid block CNC with spacer anti-seize.  
*Interamente ricavate dal pieno. Con boccola antigrippaggio.*

| BRAND     | NOTES   | COLOR | CODE         | PRICE   |
|-----------|---|-------|--------------|---------|
| UNIVERSAL | Brake lever with spacer anti-seize. Ajp-Grimeca-Bractek pump  | Grey  | 1000.001.000 | € 26,90 |
| UNIVERSAL | Brake lever with spacer anti-seize. Ajp-Grimeca-Bractek pump  | Blue  | 1000.001.002 | € 26,90 |
| UNIVERSAL | Brake lever with spacer anti-seize. Ajp-Grimeca-Bractek pump  | Red   | 1000.001.004 | € 26,90 |
| UNIVERSAL | Clutch lever with spacer anti-seize. Ajp-Grimeca-Bractek pump | Grey  | 1000.002.000 | € 26,90 |
| UNIVERSAL | Clutch lever with spacer anti-seize. Ajp-Grimeca-Bractek pump | Blue  | 1000.002.002 | € 26,90 |
| UNIVERSAL | Clutch lever with spacer anti-seize. Ajp-Grimeca-Bractek pump | Red   | 1000.002.004 | € 26,90 |



**GECO** CNC 3D LEVER / LEVE CNC 3D



**It bends but doesn't break!**  
*Si piegano ma non si spezzano!*

Completely solid block CNC - 3d working.  
 Same bending as the oem ajp lever, complete with spacer anti-seize.  
*Interamente ricavate dal pieno con lavorazione in 3D*  
*Stesse curvature della leva originale. Con boccola vite antigrippaggio.*

| BRAND     | NOTES  | COLOR  | CODE         | PRICE   |
|-----------|--|--------|--------------|---------|
| UNIVERSAL | Brake lever - Ajp-Grimeca-Bractek pump - Same bending as the original one  | Grey   | 1000.003.000 | € 37,90 |
| UNIVERSAL | Brake lever - Ajp-Grimeca-Bractek pump - Same bending as the original one  | Black  | 1000.003.001 | € 37,90 |
| UNIVERSAL | Brake lever - Ajp-Grimeca-Bractek pump - Same bending as the original one  | Orange | 1000.003.003 | € 37,90 |
| UNIVERSAL | Brake lever - Ajp-Grimeca-Bractek pump - Same bending as the original one  | Blue   | 1000.003.002 | € 37,90 |
| UNIVERSAL | Brake lever - Ajp-Grimeca-Bractek pump - Same bending as the original one  | Red    | 1000.003.004 | € 37,90 |
| UNIVERSAL | Clutch lever - Ajp-Grimeca-Bractek pump - Same bending as the original one | Grey   | 1000.004.000 | € 37,90 |
| UNIVERSAL | Clutch lever - Ajp-Grimeca-Bractek pump - Same bending as the original one | Black  | 1000.004.001 | € 37,90 |
| UNIVERSAL | Clutch lever - Ajp-Grimeca-Bractek pump - Same bending as the original one | Blue   | 1000.004.002 | € 37,90 |
| UNIVERSAL | Clutch lever - Ajp-Grimeca-Bractek pump - Same bending as the original one | Orange | 1000.004.003 | € 37,90 |
| UNIVERSAL | Clutch lever - Ajp-Grimeca-Bractek pump - Same bending as the original one | Red    | 1000.004.004 | € 37,90 |

## GECO LEVERS REGULATION BOLTS / VITI REGOLAZIONE LEVE



Brake clutch lever regulator kit (4 pcs)

*Kit viti per la regolazione del gioco di leve freno e frizione*

| BRAND     | NOTES  | COLOR | CODE          | PRICE   |
|-----------|--|-------|---------------|---------|
| UNIVERSAL | Trial lever regulation bolts ajp-bk pump 2pz.      | Black | 1000.005.001  | € 20,90 |
| UNIVERSAL | Trial lever regulation bolts ajp-bk pump 2pz.      | Blue  | 1000.005.002  | € 20,90 |
| UNIVERSAL | Trial lever regulation bolts ajp-bk pump 2pz.      | Red   | 1000.005.004  | € 20,90 |
| UNIVERSAL | Allows to adjust the clearance of trial levers 2PZ | Black | 1000.005B.001 | € 20,90 |
| UNIVERSAL | Allows to adjust the clearance of trial levers 2PZ | Blue  | 1000.005B.002 | € 20,90 |
| UNIVERSAL | Allows to adjust the clearance of trial levers 2PZ | Red   | 1000.005B.004 | € 20,90 |
| UNIVERSAL | Trial lever regulation bolts grimeca pump 4pz.     | Black | 1000.006.001  | € 38,90 |
| UNIVERSAL | Trial lever regulation bolts grimeca pump 4pz.     | Red   | 1000.006.004  | € 38,90 |

## GECO REAR FENDER SCREWS / VITI PARAFANGO POSTERIORE



Ergal screws, for a weight reduction and excellent durability.

*Viti in ergal per una consistente riduzione di peso unita ad un'ottima resistenza.*

| BRAND   | MODEL | ENGINE    | YEAR        | NOTES   | COLOR | CODE         | PRICE   |
|---------|-------|-----------|-------------|---|-------|--------------|---------|
| BETA    | EVO   | 125 > 300 | 2013 > 2023 | Rear fender screws - Trial - 5 pcs M6 - lightweight | Black | 1200.022.010 | € 36,90 |
| MONTESA | 4RT   | 250 > 280 | 2005 > 2023 | Rear fender screws - Trial - 5 pcs M6 - lightweight | Black | 1100.022.010 | € 36,90 |

## GECO TRIAL RESERVOIR COVERS / COPERCHI POMPE TRIAL



| BRAND     | MODEL  | YEAR | DESCRIPTION                       | COLOR  | CODE          | PRICE   |
|-----------|--------|------|-----------------------------------|--------|---------------|---------|
| UNIVERSAL | -      | -    | Ajp (big)                         | Red    | 1000.042.004  | € 26,90 |
| UNIVERSAL | -      | -    | Ajp (small)                       | Red    | 1000.042E.004 | € 26,90 |
| UNIVERSAL | 2013 > |      | Grimeca clutch                    | Black  | 1000.042D.001 | € 26,90 |
| UNIVERSAL | 2013 > |      | Grimeca clutch                    | Red    | 1000.042D.004 | € 26,90 |
| UNIVERSAL | 2014 > |      | Braktec clutch                    | Red    | 1000.042C.002 | € 26,90 |
| UNIVERSAL | 2014 > |      | Braktec clutch                    | Black  | 1000.042C.001 | € 26,90 |
| UNIVERSAL | 2014 > |      | Braktec clutch                    | Orange | 1000.042C.003 | € 26,90 |
| UNIVERSAL | 2014 > |      | Braktec clutch                    | Red    | 1000.042C.004 | € 26,90 |
| UNIVERSAL | 2014 > |      | Braktec clutch                    | Green  | 1000.042C.005 | € 26,90 |
| UNIVERSAL | 2014 > |      | Braktec brake                     | Black  | 1000.042G.001 | € 26,90 |
| UNIVERSAL | 2014 > |      | Braktec brake                     | Blue   | 1000.042G.002 | € 26,90 |
| UNIVERSAL | 2014 > |      | Braktec brake                     | Orange | 1000.042G.003 | € 26,90 |
| UNIVERSAL | 2014 > |      | Braktec brake                     | Red    | 1000.042G.004 | € 26,90 |
| UNIVERSAL | 2014 > |      | Braktec brake                     | Green  | 1000.042G.005 | € 26,90 |
| UNIVERSAL | > 2012 |      | Reservoir covers - Grimeca clutch | Black  | 1000.042A.001 | € 26,90 |
| UNIVERSAL | > 2012 |      | Reservoir covers - Grimeca clutch | Red    | 1000.042A.004 | € 26,90 |
| UNIVERSAL | > 2014 |      | Reservoir covers - Grimeca brake  | Black  | 1000.042F.001 | € 26,90 |
| UNIVERSAL | > 2014 |      | Reservoir covers - Grimeca brake  | Red    | 1000.042F.004 | € 26,90 |

## GECO TRIAL BAR CLAMP / SEMICOLLARINO TRIAL



Elegant design and lightness.  
For Ajp, Grimeca and Braktec pump.



*Design raffinato e leggerezza.  
Interasse dei fori 32 mm.  
Per pompe Ajp, Grimeca e Braktec*

| BRAND     | COLOR  | CODE         | PRICE   |
|-----------|--------|--------------|---------|
| UNIVERSAL | Black  | 1000.044.001 | € 32,90 |
| UNIVERSAL | Blue   | 1000.044.002 | € 32,90 |
| UNIVERSAL | Orange | 1000.044.003 | € 32,90 |
| UNIVERSAL | Red    | 1000.044.004 | € 32,90 |
| UNIVERSAL | Green  | 1000.044.005 | € 32,90 |

## GECO TRIAL ENGINE OIL PLUG / TAPPO OLIO TRIAL



| BRAND   | MODEL   | ENGINE    | YEAR        | NOTES                               | COLOR  | CODE          | PRICE  |
|---------|---------|-----------|-------------|-------------------------------------|--------|---------------|--------|
| GAS-GAS | TXT/PRO | 125 > 300 | 2011 > 2019 | Trial engine oil plug               | Black  | 1600.020.001  | € 9,90 |
|         |         |           |             |                                     | Red    | 1600.020.004  | € 9,90 |
| BETA    | EVO     | 125 > 300 | 2010 > 2023 | Trial engine oil plug               | Black  | 1200.020.001  | € 9,90 |
|         |         |           |             |                                     | Red    | 1200.020.004  | € 9,90 |
| MONTESA | 4RT     | 250 > 280 | 2005 > 2023 | Trial engine oil plug               | Orange | 1100.020.003  | € 9,90 |
|         |         |           |             |                                     | Red    | 1100.020.004  | € 9,90 |
| MONTESA | 4RT     | 250 > 280 | 2005 > 2023 | Trial engine oil plug with dipstick | Orange | 1100.020A.003 | € 9,90 |
|         |         |           |             |                                     | Red    | 1100.020A.004 | € 9,90 |

## GECO TRIAL SHOCK LINK / LEVERAGGIO TRIAL



Made in ergal 7075.

Stronger than the original one with interchangeable plastic slide.

*Più robusto dell'originale con slitta in plastica intercambiabile per la massima protezione dagli urti.*

**Comprensivi di cuscinetti e parapolvere, prodotto pronto per il montaggio.**

| BRAND   | MODEL    | ENGINE    | YEAR        | NOTES  | COLOR     | CODE          | PRICE   |
|---------|----------|-----------|-------------|--|-----------|---------------|---------|
| GAS-GAS | TXT/PRO  | 125 > 300 | 2001 > 2011 | Trial shock link with anti shock slider (couple) | Champagne | 1600.048A.000 | € 86,90 |
|         |          |           | 2013 > 2023 |  | Champagne | 1600.048.000  | € 86,90 |
| BETA    | EVO      | 125 > 300 | 2011 > 2023 | Trial shock link with anti shock slider (couple) | Champagne | 1200.048.000  | € 86,90 |
| MONTESA | COTA 4RT | 250 > 280 | 2005 > 2020 | Trial shock link with anti shock slider          | Champagne | 1100.048.000  | € 86,90 |
| GAS-GAS | TXT/PRO  | 125 > 300 | 2001 > 2011 | Trial shock link slider replacement (couple)     | Black     | 1600.048R.000 | € 30,90 |
|         |          |           | 2013 > 2020 | Trial shock link slider replacement (couple)     | Black     | 1200.048R.000 | € 30,90 |
| BETA    | EVO      | 125 > 300 | 2011 > 2020 | Trial shock link slider replacement (couple)     | Black     | 1200.048R.000 | € 30,90 |
| MONTESA | COTA 4RT | 250 > 280 | 2005 > 2020 | rial shock link slider replacement               | Black     | 1100.048R.000 | € 30,90 |

## GECO SKID ENGINE PLATE / PARAMOTORE TRIAL "HILL HOLDER"



Solid block CNC made - Aluminum made - With harpoons

Used in the Trial World Championship by Adam Raga.

*Ricavata dal pieno In alluminio con arpioni - Blocca la moto sull'ostacolo evitando lo scivolamento indietro*

*Aumenta il controllo e la stabilità in condizioni difficili*

*Utilizzata nel mondiale Trial da Adam Raga.*



| BRAND          | MODEL   | ENGINE    | YEAR        | DESCRIPTION | COLOR | CODE                | PRICE    |
|----------------|---------|-----------|-------------|-------------|-------|---------------------|----------|
| <b>GAS-GAS</b> | TXT/PRO | 125 > 300 | 2011 > 2022 |             | Grey  | <b>1600.030.000</b> | € 183,90 |
| <b>BETA</b>    | EVO     | 125 > 300 | 2011 > 2023 |             | Grey  | <b>1200.030.000</b> | € 183,90 |
| <b>SHERCO</b>  | ST      | 125 > 320 | 2016 > 2023 |             | Grey  | <b>1500.030.000</b> | € 183,90 |
| <b>MONTESA</b> | 4RT     | 250 > 280 | 2005 > 2023 |             | Grey  | <b>1100.030.000</b> | € 183,90 |
| <b>OSSA</b>    | TR      | 280       | 2011 > 2023 |             | Grey  | <b>1700.030.000</b> | € 183,90 |
| <b>SCORPA</b>  | SCORPA  | 125 > 300 | 2016 > 2023 |             | Red   | <b>1500.030.000</b> | € 183,90 |

## GECO SKID ENGINE PLATE / PARAMOTORE TRIAL



CNC machinery made stronger than oem one.

*Piastra paramotore per moto da trial rifinita a CNC. Più robusta dell'originale*

| BRAND          | MODEL   | ENGINE    | YEAR        | DESCRIPTION | COLOR | CODE                | PRICE    |
|----------------|---------|-----------|-------------|-------------|-------|---------------------|----------|
| <b>BETA</b>    | EVO     | 125 > 300 | 2012 > 2023 |             | Grey  | <b>1200.031.000</b> | € 134,90 |
| <b>MONTESA</b> | 4RT     | 250 > 280 | 2005 > 2023 |             | Grey  | <b>1100.031.000</b> | € 134,90 |
| <b>SCORPA</b>  | SR      | 125 > 300 | 2011 > 2014 |             | Grey  | <b>1800.031.000</b> | € 134,90 |
| <b>OSSA</b>    | TR      | 280       | 2011 > 2023 |             | Grey  | <b>1700.031.000</b> | € 134,90 |
| <b>GAS GAS</b> | TXT-PRO | 125 > 300 | 2011 > 2022 |             | Grey  | <b>1600.031.000</b> | € 134,90 |
| <b>SHERCO</b>  | ST      | 125 > 320 | 2016 > 2023 |             | Grey  | <b>1500.031.000</b> | € 134,90 |



CNC machinery made  
Ultralight

*Lavorata a CNC  
Ultraleggera*

**Complete with:**  
upper clamp  
lower clamp  
axle  
ergal screws  
handlebar supports diam. 28

**Comprehensive di:**  
*piastra superiore  
piastra inferiore  
perno  
viti in acciaio  
supporto manubrio diam. 28*

| BRAND          | MODEL    | ENGINE    | YEAR        | DESCRIPTION    | COLOR | CODE                 | PRICE    |
|----------------|----------|-----------|-------------|----------------|-------|----------------------|----------|
| <b>GAS-GAS</b> | TXT/PRO  | 125 > 300 | 2011 > 2015 |                | Black | <b>1600.060.001</b>  | € 383,90 |
|                |          |           |             |                | Red   | <b>1600.060.004</b>  | € 383,90 |
|                | TXT      | 125 > 300 | 2011 > 2023 | For TECH forks | Black | <b>1600.060A.001</b> | € 383,90 |
|                |          |           |             | For TECH forks | Red   | <b>1600.060A.004</b> | € 383,90 |
| <b>BETA</b>    | EVO      | 125 > 300 | 2011 > 2023 |                | Black | <b>1200.060.001</b>  | € 383,90 |
|                |          |           |             |                | Red   | <b>1200.060.004</b>  | € 383,90 |
|                | EVO      | 125 > 300 | 2011 > 2023 | For TECH forks | Black | <b>1200.060A.001</b> | € 383,90 |
|                |          |           |             | For TECH forks | Red   | <b>1200.060A.004</b> | € 383,90 |
| <b>MONTESA</b> | COTA 4RT | 250 > 280 | 2005 > 2023 |                | Black | <b>1100.060.001</b>  | € 383,90 |
|                |          |           |             |                | Red   | <b>1100.060.004</b>  | € 383,90 |

## GECO FOOTPEGS / PEDANE TRIAL



3d working

52mm width

Replaceable inox steel tips

Spacer and spring included

They don't hold the mud

Lavorazione in 3D

Maggiorate 52mm di larghezza

Punte in acciaio inox sostituibili, per una maggiore durata

Comprensive di bussola e molla in acciaio inox

Studiate per scaricare meglio il fango

| BRAND     | COLOR                                      | CODE         | PRICE    |
|-----------|--|--------------|----------|
| UNIVERSAL | Grey                                       | 1000.050.000 | € 121,90 |
| UNIVERSAL | Black                                      | 1000.050.001 | € 121,90 |
| UNIVERSAL | Orange                                     | 1000.050.003 | € 121,90 |
| UNIVERSAL | Red  | 1000.050.004 | € 121,90 |
| UNIVERSAL | Replacement steel tips and spring - 20 pcs | 000.051.000  | € 28,90  |

## GECO TRIAL AXLE BLOCKS / REGISTRI CATENA TRIAL



Inner hole 17mm

Minimum draft 16mm and 34.5mm max.

**Used in the Trial World Championship by Adam Raga.**

Foro interno diametro 17mm.

Tiraggio minimo 16mm e massimo 34.5mm.

**Utilizzati nel mondiale Trial da Adam Raga.**

| BRAND     | MODEL   | ENGINE    | YEAR        | DESCRIPTION  | COLOR  | CODE          | PRICE    |
|-----------|---------|-----------|-------------|--|--------|---------------|----------|
| UNIVERSAL |         |           |             | CNC Trial axle blocks                                | Blue   | 1000.010.002  | € 35,90  |
| UNIVERSAL |         |           |             | CNC Trial axle blocks                                | Orange | 1000.010.003  | € 35,90  |
| UNIVERSAL |         |           |             | CNC Trial axle blocks                                | Red    | 1000.010.004  | € 35,90  |
| UNIVERSAL |         |           |             | CNC Trial axle blocks                                | Black  | 1000.010.010  | € 35,90  |
| GAS-GAS   | TXT/PRO | 125 > 300 | 2014 > 2023 | Chain registers kit with axle, spacers and nut wheel | Black  | 1600.010K.000 | € 107,90 |
| OSSA      | TR      | 280W      | 2011 > 2017 | CNC Trial axle blocks                                | Green  | 1700.010.005  | € 35,90  |



Footpedal keychain CNC made as real footpedals  
 Portachiavi a forma di pedana ricavati dal pieno CNC come le vere pedane

| COLOR  | CODE               | PRICE   |
|--------|--------------------|---------|
| Blue   | <b>000.500.002</b> | € 15,90 |
| Orange | <b>000.500.003</b> | € 15,90 |
| Red    | <b>000.500.004</b> | € 15,90 |
| Green  | <b>000.500.005</b> | € 15,90 |
| Yellow | <b>000.500.006</b> | € 15,90 |
| Purple | <b>000.500.008</b> | € 15,90 |





Nata nel 2000 dalla passione dei propri titolari per tutto ciò che ruota attorno alle moto, Bolt progetta, produce e distribuisce kit di fissaggio aftermarket. Ogni confezione e prodotto è accuratamente studiato analizzando l'originale con l'obiettivo di migliorarne le caratteristiche, replicarne fedelmente le dimensioni e fornire ai clienti Bolt soluzioni pratiche, utili ed economiche. Bolt esamina ogni moto ogni anno per verificare ed implementare ogni articolo con gli aggiornamenti necessari e farne un prodotto indispensabile per ogni appassionato.

|                                  |          |
|----------------------------------|----------|
| PRO PACK                         | pag. 355 |
| TRACK PACK                       | pag. 358 |
| Kit viti fissaggio plastiche     | pag. 361 |
| Viti corona                      | pag. 365 |
| Dadi ruota ATV                   | pag. 366 |
| Rosette cambio olio              | pag. 366 |
| Registri catena rapidi           | pag. 367 |
| Kit viti freno                   | pag. 369 |
| Viti registro catena             | pag. 370 |
| Set guarnizioni/viteria marmitta | pag. 370 |
| Vite fissaggio sella serbatoio   | pag. 370 |

**ITALY DISTRIBUTION ONLY**

**CRF PRO PACK**

Il Pro-pack CR-CRF è composto da oltre 200 pezzi e contiene: viti M5, M6 e M8 a testa flangiata per il fissaggio di telaietto posteriore, parasteli, convogliatori, fiancattine, tabella portanumero, parafanghi, sella. Inoltre rosette, boccole, dadi autobloccanti, viti registro catena e molto altro.

Tutti i componenti replicano fedelmente gli originali per dimensioni e caratteristiche.

Aggiornato alle versioni 2015.



| MARCA         | MODELLO              | CILINDRATA         | ANNO                       | DESCRIZIONE     | CODICE           | PREZZO  |
|---------------|----------------------|--------------------|----------------------------|-----------------|------------------|---------|
| Replica HONDA | CRF / CRF/RX<br>CRFX | 250-450<br>250-450 | 2002 > 2023<br>2004 > 2023 | PRO PACK CR-CRF | <b>2008CRFPP</b> | € 63,95 |

**YZ-YZF PRO PACK**

Il Pro Pack YZ-YZF fornisce tutto il necessario per sostituire la viteria originale dei modelli cross ed enduro di casa Yamaha.

Contiene le viti per il fissaggio del telaietto posteriore, di tutte le plastiche, della sella e di molto altro ancora.

Adatto ai modelli dal 2002 al 2015.

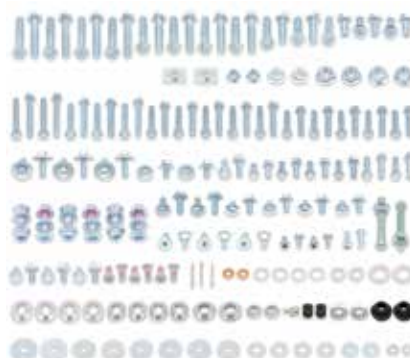

| MARCA          | MODELLO                 | CILINDRATA                         | ANNO   | DESCRIZIONE          | CODICE          | PREZZO  |
|----------------|-------------------------|------------------------------------|--|----------------------|-----------------|---------|
| Replica YAMAHA | YZ<br>YZF<br>WRF<br>WRF | 125-250<br>250 > 450<br>250<br>450 | 2002 > 2023<br>2002 > 2023<br>2003 > 2023<br>2003 > 2023 | PRO PACK YZ-YZF      | <b>BMHYZPP</b>  | € 63,95 |
|                | YZ                      | 125 2t                             | 2002 > 2023  | PRO PACK YZ 2 tempi  | <b>YZPP-125</b> | € 73,95 |
|                | YZ / YZ-X               | 250 2t                             | 2002 > 2023  | PRO PACK YZ 2 tempi  | <b>YZPP-250</b> | € 73,95 |
|                | YZF / WRF / YZ-FX       | 250-500 4t                         | 2014 > 2023  | PRO PACK YZF 4 tempi | <b>YZPP-14</b>  | € 73,95 |
|                | WRF                     | 250                                | 2015 > 2023  |                      |                 |         |
|                | WRF                     | 450                                | 2016 > 2023  |                      |                 |         |

**KTM PRO PACK**

Il Pro-pack KTM è composto da oltre 180 pezzi e contiene: viti M6 e M8 a testa flangiata per il fissaggio di telaietto posteriore, parasteli, convogliatori, fiancattine, tabella portanumero, parafanghi, sella. Inoltre rosette, boccole, dadi autobloccanti, viti registro catena e molto altro.

Tutti i componenti replicano fedelmente gli originali per dimensioni e caratteristiche.



| MARCA       | MODELLO            | CILINDRATA                     | ANNO                                      | DESCRIZIONE  | CODICE   | PREZZO                        |
|-------------|--------------------|--------------------------------|---|--------------|--|-------------------------------|
| Replica KTM | SX<br>SX<br>SX-SXF | 50-65<br>85 > 150<br>200 > 300 | 2003 > 2023<br>2003 > 2023<br>2000 > 2023 | PRO PACK KTM | <b>EUPP-50/65</b><br><b>EUPP-85/150</b><br><b>EUPP-200/300</b> | € 73,95<br>€ 73,95<br>€ 73,95 |

**ITALY DISTRIBUTION ONLY**

**KX-KXF PRO PACK**

Il Pro Pack KX-KXF fornisce tutto il necessario per sostituire la viteria originale dei modelli Kawasaki.

Include il dado autobloccante per il perno ruota che consente di eliminare la cupiglia di sicurezza oltre alle viti per il fissaggio del telaio posteriore, di tutte le plastiche, della sella e di molto altro ancora.

Adatto ai modelli dal 2003 al 2015.



| MARCA            | MODELLO | CILINDRATA | ANNO        | DESCRIZIONE     | CODICE         | PREZZO  |
|------------------|---------|------------|-------------|-----------------|----------------|---------|
| Replica KAWASAKI | KX      | 125-250    | 2003 > 2008 | PRO PACK KX-KXF | <b>BMHKXPP</b> | € 63,95 |
|                  | KXF     | 250-450    | 2004 > 2023 |                 |                |         |
|                  | KLXR    | 450        | 2007 > 2023 |                 |                |         |

**RM-RMZ PRO PACK**

Il Pro Pack RM-RMZ fornisce tutto il necessario per sostituire la viteria originale delle Suzuki da fuoristrada.

Contiene le viti per il fissaggio del telaio posteriore, di tutte le plastiche, della sella e di molto altro ancora.

Adatto ai modelli dal 2001 al 2015.



| MARCA          | MODELLO | CILINDRATA | ANNO        | DESCRIZIONE     | CODICE         | PREZZO  |
|----------------|---------|------------|-------------|-----------------|----------------|---------|
| Replica SUZUKI | RM      | 125-250    | 2001 > 2011 | PRO PACK RM-RMZ | <b>BMHRMPP</b> | € 63,95 |
|                | RMZ     | 250-450    | 2004 > 2023 |                 |                |         |
|                | RMXZ    | 450        | 2010 > 2023 |                 |                |         |

**HUSKY PRO PACK**

Il Pro Pack HUSKPP fornisce tutto il necessario per sostituire la viteria originale delle Husqvarna da fuoristrada.

Contiene le viti per il fissaggio del telaio posteriore, di tutte le plastiche, della sella e di molto altro ancora.

Adatto ai modelli dal 2014 al 2022.

| MARCA             | MODELLO                      | CILINDRATA | ANNO        | DESCRIZIONE    | CODICE        | PREZZO  |
|-------------------|------------------------------|------------|-------------|----------------|---------------|---------|
| Replica HUSQVARNA | TC / TE / TX / FC<br>FE / FX | 50 > 500   | 2014 > 2023 | PRO PACK HUSKY | <b>HUSKPP</b> | € 73,95 |

**ITALY DISTRIBUTION ONLY**

**JAPANESE PRO PACK**

Il Japanese Pro-pack è composto da viteria metrica universale che replica i componenti più comuni utilizzati sulle moto da fuoristrada giapponesi. Include viti corona e viti registri catena. Non include componenti in alluminio. Tutti i componenti eguagliano o migliorano lo standard qualitativo degli originali.

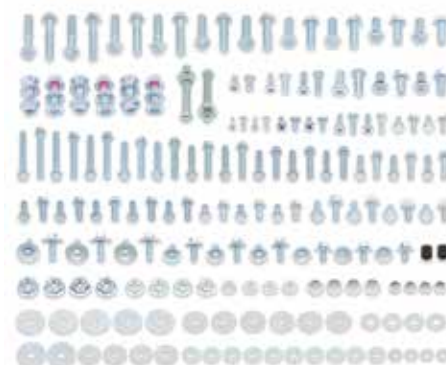

| MARCA      | DESCRIZIONE                             | CODICE | PREZZO  |
|------------|---|--------|---------|
| Universale | PRO PACK universale per moto giapponesi | 2004PP | € 49,95 |

**EURO PRO PACK**

Dedicato ai modelli più recenti Ktm ed Husaberg ma adatto anche ai modelli di casa Husqvarna e Gas Gas, il kit Euro Pro pack è composto da più di 140 pezzi e consente ad ogni appassionato la sostituzione della viteria originale con componentistica superiore in quanto a finiture e resistenza. Include viti flangiate M6 e M8, le viti dedicate ai convogliatori ed al fissaggio di tutte le plastiche, rosette concave, cupiglie, boccole, viti corona, viti M5 flangiate e molto altro. Aggiornato alle versioni 2015.



| MARCA      | DESCRIZIONE                          | CODICE   | PREZZO  |
|------------|--------------------------------------|----------|---------|
| Universale | PRO PACK universale per moto europee | 2004EUPP | € 63,95 |

**SPORT BIKE PRO PACK**

Ideale per le esigenze di piloti e meccanici che necessitano di un kit viti per moto sportive stradali giapponesi. Contiene oltre 250 componenti di qualità replica dei modelli più diffusi. Composto da rivetti e fissaggi in nylon, viti flangiate, viti a testa bombata, viti a brugola, rosette, dadi autobloccanti e molto altro ancora.

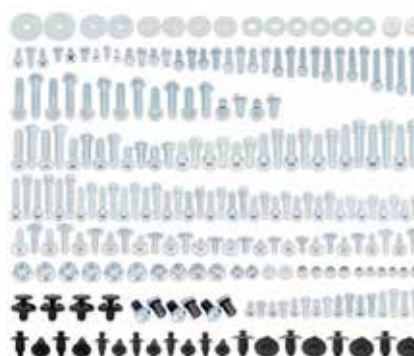

| MARCA      | DESCRIZIONE                           | CODICE   | PREZZO  |
|------------|---------------------------------------|----------|---------|
| Universale | PRO PACK universale per moto stradali | 2006SBPP | € 54,95 |

**ITALY DISTRIBUTION ONLY**

**CRF TRACK PACK**

**€ 105,95\*** PREZZO DI VENDITA AL PUBBLICO PER SINGOLA CONFEZIONE €18.65

Ogni Track-pack CRF è composto da 56 pezzi. Contiene viti M5, M6 e M8 a testa flangiata. Tra queste le viti per il fissaggio del telaio posteriore, viti parasteli, viti per il fissaggio di fiancattine, tabella portanumero, parafango anteriore e posteriore, viti fissaggio sella. Include anche rosette, boccole e dadi autobloccanti. Aggiornato alle versioni 2015.



| MARCA         | MODELLO    | CILINDRATA | ANNO        | DESCRIZIONE                         | CODICE          | PREZZO   |
|---------------|------------|------------|-------------|-------------------------------------|-----------------|----------|
| Replica HONDA | CRF/CRF-RX | 250-450    | 2002 > 2020 | CRF TRACK PACK - Espositore da 6 pz | <b>20086CRF</b> | € 105,95 |

**JAPANESE TRACK PACK**

**€ 83,95\*** PREZZO DI VENDITA AL PUBBLICO PER SINGOLA CONFEZIONE €18.65

Il Japanese Track Pack è un kit unico per praticità e versatilità. È composto da 54 pezzi indispensabili in campo gara per provvedere alla sostituzione od allo smarrimento del componente originale. Indicato per Kawasaki KX-KXF, Suzuki RM -Rmz e Yamaha YZ-YZF. Aggiornato alle versioni 2015.



| MARCA      | DESCRIZIONE   | CODICE          | PREZZO  |
|------------|---|-----------------|---------|
| Universale | TRACK PACK universale per moto giapponesi. Espositore da 6 pz | <b>20036JTP</b> | € 83,95 |

**ITALY DISTRIBUTION ONLY****YZF TRACK PACK**

Questo kit di 49 pezzi è un must nella cassetta degli attrezzi di tutti i piloti YZ / YZF.

Il Track Pack contiene la viteia sostituita più frequentemente sui modelli cross ed enduro Yamaha.

Questo kit comprende: bulloni testa flangiata M6 e M8 Yamaha style, viti generiche, viti parasteli forcella, viti radiatore, viti fissaggio cruna catana e fascia scorricatena, dadi fissaggio parafango posteriore, dadi flangiati e altro ancora. Progettato per i modelli YZ, YZF e WRF dal 2000 al 2015.

**€ 105,95\*** PREZZO DI VENDITA AL PUBBLICO PER SINGOLA CONFEZIONE €18.65



| MARCA          | MODELLO    | CILINDRATA | ANNO        | DESCRIZIONE                         | CODICE           | PREZZO   |
|----------------|------------|------------|-------------|-------------------------------------|------------------|----------|
| Replica YAMAHA | YZ/YZF/WRF | 125 > 450  | 2000 > 2022 | YZF TRACK PACK - Espositore da 6 pz | <b>20146YZTP</b> | € 105,95 |

**KXF TRACK PACK**

Questo kit di 48 pz contiene l'essenziale per risolvere le piccole emergenze che puo creare la rottura di un dado o bullone in campo gara.

Il kit contiene: viti generiche testa flangiata M6 e M8, viti radiatore, viti parasteli forcella, viti telaietto, bulloni della pompa del freno, dadi fissaggio parafango posteriore, dadi flangiati ribassati e molto altro ancora!

Progettato per modelli KX e KXF dal 2000 al 2015.

**€ 105,95\*** PREZZO DI VENDITA AL PUBBLICO PER SINGOLA CONFEZIONE €18.65



| MARCA            | DESCRIZIONE                       | CODICE                              | PREZZO                    |
|------------------|-----------------------------------|-------------------------------------|---------------------------|
| Replica KAWASAKI | KX/KXF/KLXR 125 > 450 2000 > 2018 | KXF TRACK PACK - Espositore da 6 pz | <b>20146KXTP</b> € 105,95 |

**ITALY DISTRIBUTION ONLY**

**EURO TRACK PACK**

Dedicato ai modelli più recenti di Ktm ed Husaberg ma adatto anche ai modelli di casa Husqvarna e Gas Gas. Il pratico kit Euro track pack è composto da 50 pezzi e consente la sostituzione in campo gara della viteria originale con componentistica superiore in fatto di finiture e di resistenza. Include viti flangiate M5, M6 ed M8. Tra queste le viti per fissaggio dei convogliatori e di tutte le plastiche, rosette concave, cupiglie, boccole e viti M5 flangiate. Aggiornato alle versioni 2014.

6TP-HSK  
**€ 105,95\***

PREZZO DI VENDITA AL PUBBLICO PER SINGOLA CONFEZIONE €18.65

20046EU  
**€ 105,95\***

PREZZO DI VENDITA AL PUBBLICO PER SINGOLA CONFEZIONE €22.65



| MARCA      | DESCRIZIONE  | CODICE  | PREZZO   |
|------------|--|---------|----------|
| Universale | TRACK PACK universale per moto europee. Espositore da 6 pz | 20046EU | € 105,95 |
| Husqvarna  | Husqvarna TRACK PACK - 50cc - 501cc dal 2014 al 2022       | 6TP-HSK | € 105,95 |

**ATV TRACK PACK**

Realizzato per le esigenze di piloti e meccanici che necessitano di un kit viti universale per Quad ed Atv.

Composto da 98 componenti realizzati in qualità replica dei modelli giapponesi più diffusi. Contiene tra l'altro rivetti, viti flangiate, viti a testa bombata, viti a brugola, cupiglie, rosette, dadi autobloccanti e molto altro ancora.

**€ 131,95\***

PREZZO DI VENDITA AL PUBBLICO PER SINGOLA CONFEZIONE €31.15



| MARCA      | DESCRIZIONE  | CODICE   | PREZZO   |
|------------|--|----------|----------|
| Universale | TRACK PACK universale per ATV/Quad. Espositore da 6 pz | 20076ATP | € 131,95 |

**ITALY DISTRIBUTION ONLY**

**REPLICA HONDA**

I kit viti per fissaggio plastiche Bolt sono realizzati con componenti di qualità superiore agli originali in quanto a resistenza e finiture. Disponibili in versioni specifiche per ogni modello di moto, contengono le boccole necessarie al fissaggio delle plastiche e le relative viti.

**Alcuni articoli di questo paragrafo verranno sostituiti e raggruppati in un unico prodotto con un nuovo codice**



Codice HON0007124

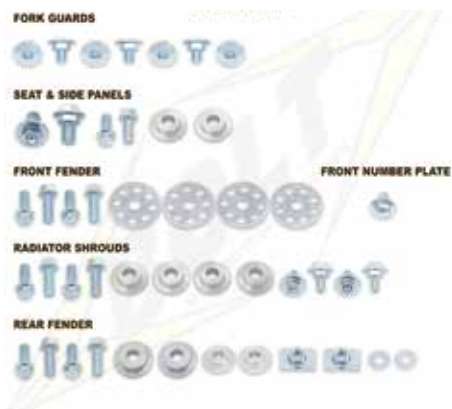

Codice HON0409024



Codice HON0609020



Codice HON0911024

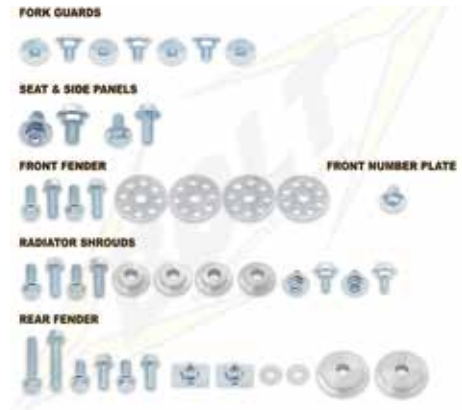

Codice HON0508004

| MARCA         | MODELLO    | CILINDRATA | ANNO        | CODICE | PREZZO | CODICE NUOVO | PREZZO  |
|---------------|------------|------------|-------------|--------|--------|--------------|---------|
| Replica HONDA | CR         | 125-250    | 2000 > 2007 |        |        | HON0007124   | € 22,95 |
|               | CRF        | 450        | 2002 > 2004 |        |        |              |         |
|               | CRF        | 150        | 2007 > 2023 |        |        | HON-0716150  | € 20,95 |
|               | CRFX       | 250        | 2004 > 2017 |        |        | HON-PFK1     | € 26,95 |
|               | CRFX       | 450        | 2005 > 2018 |        |        |              |         |
|               | CRF        | 450        | 2005 > 2008 |        |        |              |         |
|               | CRF        | 250        | 2004 > 2009 |        |        |              |         |
|               | CRF-CRF RX | 250        | 2010 > 2021 |        |        | HON-PFK2     | € 23,95 |
|               | CRF-CRF RX | 450        | 2009 > 2020 |        |        |              |         |
|               | CRFX       | 450        | 2017 > 2020 |        |        |              |         |
|               | CRF        | 250        | 2014 > 2017 |        |        | HON1300004   | € 23,95 |
|               | CRF        | 450        | 2013 > 2016 |        |        |              |         |

**ITALY DISTRIBUTION ONLY**

**REPLICA YAMAHA**



Codice YAM0211120

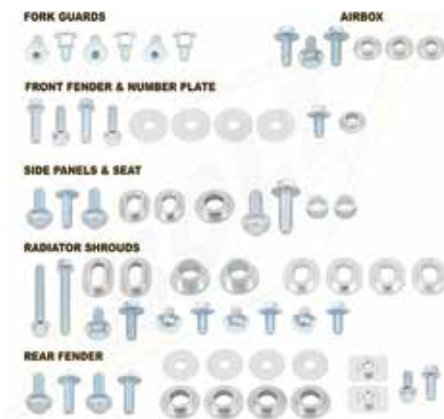

Codice YAM1400024



Codice YAM1010020



Codice YAM0610024

| MARCA          | MODELLO | CILINDRATA  | ANNO        | CODICE            | PREZZO  | CODICE NUOVO      | PREZZO  |
|----------------|---------|-------------|-------------|-------------------|---------|-------------------|---------|
| Replica YAMAHA | YZ      | 85          | 2002 > 2023 | <b>YAM-021785</b> | € 20,95 |                   |         |
|                | YZ      | 125-250     | 2002 > 2021 |                   |         | <b>YAM-PFK1</b>   | € 27,95 |
|                | YZF     | 250-450     | 2003 > 2009 |                   |         |                   |         |
|                | WRF     | 250         | 2003 > 2013 |                   |         |                   |         |
|                | WRF     | 450         | 2003 > 2011 |                   |         |                   |         |
|                | YZF     | 250-450     | 2006 > 2009 |                   |         | <b>YAM0610024</b> | € 34,90 |
|                | WRF     | 250         | 2007 > 2014 |                   |         |                   |         |
|                | WRF     | 450         | 2007 > 2011 |                   |         |                   |         |
|                | YZF     | 250         | 2010 > 2013 | <b>YAM1010020</b> | € 27,95 |                   |         |
|                | WRF     | 450         | 2012 > 2014 |                   |         |                   |         |
|                | YZF     | 250         | 2014 > 2018 | <b>YAM1400024</b> | € 45,95 |                   |         |
|                | YZF     | 450         | 2014 > 2017 |                   |         |                   |         |
|                | WRF     | 250         | 2015 > 2019 |                   |         |                   |         |
|                | WRF     | 450         | 2015 > 2018 |                   |         |                   |         |
|                | YZF     | 250         | 2019 > 2023 | <b>YAM1800004</b> | € 45,95 |                   |         |
|                | YZF     | 450         | 2018 > 2022 |                   |         |                   |         |
|                | YZFX    | 250         | 2021 > 2023 |                   |         |                   |         |
| YZFX           | 450     | 2020 > 2023 |             |                   |         |                   |         |
| WRF            | 250     | 2020 > 2023 |             |                   |         |                   |         |
| WRF            | 450     | 2019 > 2022 |             |                   |         |                   |         |

**ITALY DISTRIBUTION ONLY**

**REPLICA KAWASAKI**

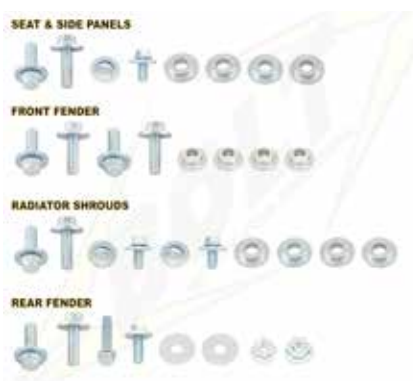

Codice KAW-1200024

| MARCA            | MODELLO | CILINDRATA | ANNO        | CODICE             | PREZZO  |
|------------------|---------|------------|-------------|--------------------|---------|
| Replica KAWASAKI | KX      | 65         | 2000 > 2023 | <b>KAW-001765</b>  | € 20,95 |
|                  | KX      | 85         | 2014 > 2023 | <b>KAW-141785</b>  | € 20,95 |
|                  | KX      | 125-250    | 2003 > 2007 | <b>KAW-1200024</b> | € 20,95 |
|                  | KXF     | 250        | 2004 > 2016 |                    |         |
|                  | KXF     | 450        | 2004 > 2015 |                    |         |
|                  | KXLR    | 450        | 2007 > 2016 |                    |         |

**REPLICA SUZUKI**

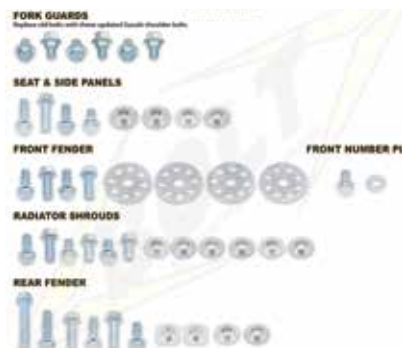

Codice SUZ0108120

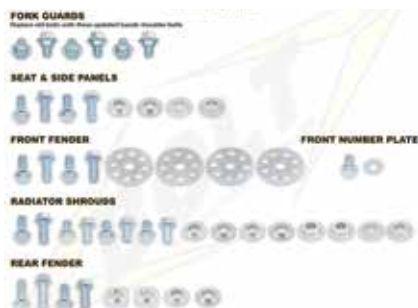

Codice SUZ0710020

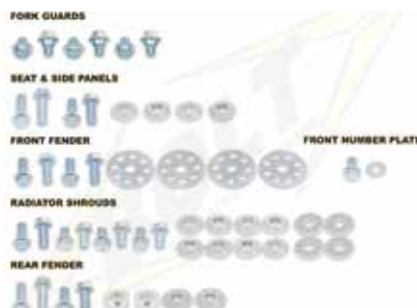

Codice SUZ081004

| MARCA          | MODELLO | CILINDRATA | ANNO        | CODICE            | PREZZO  | CODICE NUOVO   | PREZZO  |
|----------------|---------|------------|-------------|-------------------|---------|----------------|---------|
| Replica SUZUKI | RM      | 125-250    | 2001 > 2008 | <b>SUZ0108120</b> | € 20,95 |                |         |
|                | RMZ     | 250        | 2007 > 2009 |                   |         | <b>SU-PFK1</b> | € 20,95 |
|                | RMZ     | 450        | 2005 > 2007 |                   |         |                |         |
|                | RMZ     | 250        | 2010 > 2018 | <b>SUZ0810004</b> | € 20,95 |                |         |
|                | RMZ     | 450        | 2008 > 2017 |                   |         |                |         |
|                | RMZX    | 450        | 2010 > 2017 |                   |         |                |         |
|                | RMZ     | 250        | 2019 > 2023 | <b>SUZ1800004</b> | € 22,95 |                |         |
|                | RMZ     | 450        | 2018 > 2023 |                   |         |                |         |

**ITALY DISTRIBUTION ONLY**

**REPLICA KTM**

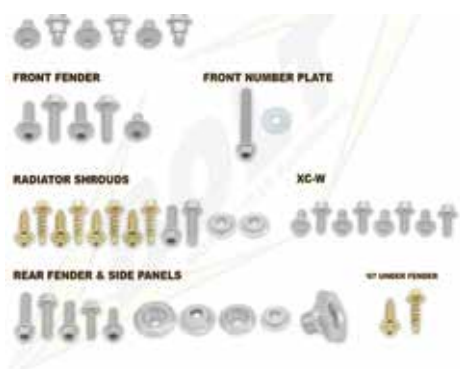

Codice KTM0710SX0810XC



Codice KTM0810EXC



Codice KTM-112SXC12EXC

| MARCA       | MODELLO           | CILINDRATA                    | ANNO        | CODICE                | PREZZO  | CODICE NUOVO    | PREZZO  |
|-------------|-------------------|-------------------------------|-------------|-----------------------|---------|-----------------|---------|
| Replica KTM | SX                | 50                            | 2002 > 2023 | <b>KTM-021750SX</b>   | € 20,95 |                 |         |
|             | SX                | 65                            | 2016 > 2023 | <b>KTM-1665SX</b>     | € 20,95 |                 |         |
|             | SX                | 85                            | 2013 > 2017 | <b>KTM-131785SX</b>   | € 20,95 |                 |         |
|             | SX / SX-F         | 125 > 530                     | 2003 > 2016 |                       |         | <b>KTM-PFK1</b> | € 26,95 |
|             | XC / XC-F         | 125 > 530                     | 2003 > 2016 |                       |         |                 |         |
|             | XCF-W / XC-W      | 125 > 530                     | 2003 > 2016 |                       |         |                 |         |
|             | EXC / EXC-F / MXC | 125 > 530                     | 2003 > 2016 |                       |         |                 |         |
|             | SX                | 125-250-250F-350F-450         | 2016 > 2018 | <b>KTM-16SXC17EXC</b> | € 20,95 |                 |         |
|             | SX                | 250                           | 2017 > 2018 |                       |         |                 |         |
|             | SXF               | 250-350-450                   | 2016 > 2018 |                       |         |                 |         |
| Replica KTM | XC                | 250F-450F-500F                | 2016 > 2018 | <b>KTM-16SXC17EXC</b> | € 20,95 |                 |         |
|             | XC-W              | 125-200-250-300               | 2016 > 2018 |                       |         |                 |         |
|             | EXC               | 125-250-250F-300-350F-450-500 | 2017 > 2019 |                       |         |                 |         |

**REPLICA HUSQVARNA**

| MARCA             | MODELLO     | CILINDRATA          | ANNO        | CODICE                | PREZZO  | CODICE NUOVO     | PREZZO  |
|-------------------|-------------|---------------------|-------------|-----------------------|---------|------------------|---------|
| Replica HUSQVARNA | TC / TX     | 125                 | 2016 > 2018 | <b>KTM-16SXC17EXC</b> | € 20,95 |                  |         |
|                   | TC          | 250                 | 2017-2018   |                       |         |                  |         |
|                   | FC-FS       | 250-350-450         | 2016 > 2018 |                       |         |                  |         |
|                   | TE/FE       | 250-300-350-450-500 | 2017-2018   |                       |         |                  |         |
|                   | FC/FX/TC/TX | 50 > 500            | 2014 > 2022 |                       |         | <b>HSKY-PFK1</b> | € 20,95 |
|                   | FE/TE       | 50 > 500            | 2014 > 2023 |                       |         |                  |         |
|                   | FE          | 501                 | 2017 > 2023 | <b>E-KTMF4-1620</b>   | € 20,95 |                  |         |

**REPLICA HUSABERG**

| MARCA            | MODELLO | CILINDRATA              | ANNO        | CODICE | PREZZO | CODICE NUOVO     | PREZZO  |
|------------------|---------|-------------------------|-------------|--------|--------|------------------|---------|
| Replica HUSABERG | TE-FE   | 125-250-300-350-450-501 | 2014 > 2023 |        |        | <b>HSKY-PFK1</b> | € 20,95 |

**ITALY DISTRIBUTION ONLY**

Confezione da 6 pezzi contenente viti e dadi autobloccant M8 in acciaio 10.9.  
 Su ogni vite è applicato del frenafili di resistenza media per una maggiore sicurezza e tenuta.  
 Incluso nella confezione anche un inserto esagonale da 8mm zincato da applicare nella corrispondente sede sulla testa della vite per facilitare il serraggio e la rimozione.  
 Disponibili zincate bianche o nere.

**Codice 2008HSB**



**Codice 2008HSEU**



**Codice 2008HSS**

| MARCA                            | DESCRIZIONE  | COLORE | CODICE             | PREZZO  |
|----------------------------------|--|--------|--------------------|---------|
| UNIVERSALE                       | Viti corona universali per moto giapponesi zincate | Nero   | <b>2008HSB</b>     | € 10.95 |
| UNIVERSALE                       | Viti corona universali per moto giapponesi zincate | Silver | <b>2008HSS</b>     | € 10.95 |
| REPLICA KTM, HUSQVARNA, HUSABERG | Viti corona replica KTM zincate                    | Silver | <b>2008HSEU</b>    | € 10.95 |
| REPLICA HONDA                    | Viti corona replica HONDA zincate                  | Silver | <b>2008-HS.CRF</b> | € 10.95 |

**ITALY DISTRIBUTION ONLY**

Concepito per eliminare il problema dell'allentamento dei dadi ruota, questo kit include 8 dadi flangiati ed 8 adattatori conici. Indicato per l'applicazione sui cerchi ruota dei più diffusi quad giapponesi in commercio, si adatta a sedi piatte o svasate. Disponibili in versione zincata silver o nera.



**Codice 2005LUGB**



**Codice 2005LUGS**

| MARCA      | DESCRIZIONE        | COLORE  | CODICE          | PREZZO |
|------------|--------------------|---------|-----------------|--------|
| Universale | Kit dadi ruota ATV | Nero    | <b>2005LUGB</b> | € 9,95 |
| Universale | Kit dadi ruota ATV | Zincato | <b>2005LUGS</b> | € 9,95 |

**ROSETTE CAMBIO OLIO**

Rosette in rame ed alluminio per la sostituzione dopo il cambio olio realizzate in varie dimensioni . Disponibile anche un kit specifico replica per Honda CRF-CRFX.



**Codice DPWM6M8H**

3 pz M6x11 mm in rame  
6 pz M8x15mm in alluminio

**Codice DPWM1014510**

**Codice DPWM101810**

**Codice DPWM122010**

**Codice DPWM1422310**

**Codice DPWM61110**

**Codice DPWM81510**

| MARCA      | MOD.   | CILINDRATA  | ANNO                         | DESCRIZIONE                                 | MATERIALE      | CODICE                 | PREZZO |
|------------|--------|-------------|------------------------------|---|----------------|------------------------|--------|
| HONDA      | CRF    | 250-450     | 2002 > 2020                  | Rosette assortite cambio olio CRF-CRFX      | Rame-Alluminio | <b>DPWM6M8H</b>        | € 3.95 |
|            | CRF-RX | 250         | 2015 > 2023                  | O-ring e rosette cambio olio                | Rame-Alluminio | <b>OILCHG-CRF</b>      | € 6.95 |
|            | CRFX   | 250-450     | 2005 > 2017                  | Rosette assortite cambio olio CRF-CRFX      | Rame-Alluminio |                        |        |
|            | CRF    | 150         | 2007 > 2023                  | O-ring e rosette cambio olio                | Rame-Alluminio |                        |        |
|            | CRF    | 250         | 2004 > 2023                  | O-ring e rosette cambio olio                | Rame-Alluminio |                        |        |
|            | CRF-RX | 250         | 2004 > 2023                  | O-ring e rosette cambio olio                | Rame-Alluminio |                        |        |
| CRF        | 450    | 2002 > 2016 | O-ring e rosette cambio olio | Rame-Alluminio                              |                |                        |        |
| CRF-RX     | 450    | 2004 > 2018 | O-ring e rosette cambio olio | Rame-Alluminio                              |                |                        |        |
| KTM        | SX-SXF | 125 > 525   | 2000 > 2020                  | Rosette in rame                             |                | <b>DPW.KTM</b>         | € 3.95 |
| YAMAHA     | YZF    | 250         | 2015 > 2023                  | O-ring e rosette cambio olio                | Rame-Alluminio | <b>OILCHG-YZF</b>      | € 6.95 |
|            | YZF    | 450         | 2010 > 2023                  | O-ring e rosette cambio olio                | Rame-Alluminio |                        |        |
|            | WRF    | 250         | 2015 > 2023                  | O-ring e rosette cambio olio                | Rame-Alluminio |                        |        |
|            | WRF    | 450         | 2016 > 2023                  | O-ring e rosette cambio olio                | Rame-Alluminio |                        |        |
| KAWASAKI   | KXF    | 250         | 2004 > 2023                  | O-ring e rosette cambio olio                | Rame-Alluminio | <b>OILCHG-KXF2</b>     | € 6.95 |
|            | KXF    | 450         | 2016 > 2023                  | O-ring e rosette cambio olio                | Rame-Alluminio | <b>OILCHG-KXF4.16+</b> | € 6.95 |
| UNIVERSALI |        |             |                              | Conf. 10 pz rosette cambio olio M10x14,5 mm | Alluminio      | <b>DPWM1014510</b>     | € 3.95 |
|            |        |             |                              | Conf. 10 pz rosette cambio olio M10x18 mm   | Alluminio      | <b>DPWM101810</b>      | € 3.95 |
|            |        |             |                              | Conf. 10 pz rosette cambio olio M12x20 mm   | Alluminio      | <b>DPWM122010</b>      | € 3.95 |
|            |        |             |                              | Conf. 10 pz rosette cambio olio M14x22,3 mm | Alluminio      | <b>DPWM1422310</b>     | € 3.95 |
|            |        |             |                              | Conf. 10 pz rosette cambio olio M6x11 mm    | Rame           | <b>DPWM61110</b>       | € 3.95 |
|            |        |             |                              | Conf. 10 pz rosette cambio olio M8x15 mm    | Alluminio      | <b>DPWM81510</b>       | € 3.95 |

**ITALY DISTRIBUTION ONLY**

Registri catena rapidi ricavati dal pieno in lega di alluminio 6061, rimangono in posizione senza cadere durante il cambio ruota. I registri Bolt sono gli unici che richiedono una sola chiave da 10 mm per la regolazione della tensione catena. Sono dotati di tacche per la regolazione e l'allineamento millimetrico della ruota posteriore. Anodizzati in vari colori hanno un lubrificante pre-applicato sulla parte filettata per favorirne il montaggio.

**REPLICA HONDA**

| MOD.   | CIL.    | ANNO        | COLORE | CODICE              | PREZZO  |
|--------|---------|-------------|--------|---------------------|---------|
| CR     | 125-250 | 2000 > 2007 | Rosso  | <b>2009CHADCRRD</b> | € 49,95 |
| CRF/   | 250-450 | 2002 > 2020 |        |                     |         |
| CRF-RX |         |             |        |                     |         |
| CRFX   | 250-450 | 2004 > 2019 |        |                     |         |

**REPLICA KAWASAKI**

| MOD. | CIL.    | ANNO        | COLORE | CODICE              | PREZZO  |
|------|---------|-------------|--------|---------------------|---------|
| KX   | 125-250 | 2003 > 2008 | Rosso  | <b>2009CHADKXRD</b> | € 62,95 |
| KXF  | 250-450 | 2003 > 2020 |        |                     |         |
| KLXR | 450     | 2007 > 2016 |        |                     |         |

**REPLICA YAMAHA**

| MOD. | CIL.    | ANNO        | COLORE | CODICE                | PREZZO  |
|------|---------|-------------|--------|-----------------------|---------|
| YZ   | 125-250 | 2004 > 2020 | Nero   | <b>2009CHADYZBK</b>   | € 49,95 |
| YZF  | 250-450 | 2002 > 2008 |        |                       |         |
| WRF  | 250     | 2002 > 2020 |        |                       |         |
| WRF  | 450     | 2002 > 2020 |        |                       |         |
| YZF  | 250     | 2009 > 2011 | Nero   | <b>2009CHADYZ09BK</b> | € 62,95 |
| YZF  | 450     | 2009        |        |                       |         |
| YZF  | 450     | 2010 > 2020 | Nero   | <b>2010CHADYZ4BK</b>  | € 49,95 |
| YZF  | 250     | 2012 > 2020 |        |                       |         |

**REPLICA SUZUKI**

| MOD. | CIL.    | ANNO        | COLORE | CODICE               | PREZZO  |
|------|---------|-------------|--------|----------------------|---------|
| RMZ  | 250-450 | 2004 > 2020 | Rosso  | <b>2009CHADRMZRD</b> | € 62,95 |
| RMZX | 450     | 2010 > 2020 |        |                      |         |

**ITALY DISTRIBUTION ONLY**

**REPLICA KTM**



| MOD.       | CILINDRATA                    | ANNO        | COLORE  | CODICE               | PREZZO  |
|------------|-------------------------------|-------------|---------|----------------------|---------|
| SX-EXC     | 125-144-250-250F-350F-450-505 | 2005 > 2012 | Arancio | <b>2009CHADKTMOR</b> | € 54,95 |
| LC4        | 640-690                       | 2005 > 2017 |         |                      |         |
| EXC / EXCF | 125-250-250F-350F-450         | 2013 > 2020 | Arancio | <b>2014CHADKTMOR</b> | € 54,95 |



**ACCEDI AL VIDEO**



## ITALY DISTRIBUTION ONLY

## REPLICA HONDA

Kit dadi e viti a testa flangiata per dischi freno anteriore o posteriore Honda CR - CRF.

Confezione composta da 6 viti zincate M6x19 e 6 dadi autobloccanti .



| MOD.   | CILINDRATA | ANNO        | CODICE          | PREZZO |
|--------|------------|-------------|-----------------|--------|
| CR     | 125-250    | 1995 > 2007 | <b>2009HRTR</b> | € 7,95 |
| CRF    | 250        | 2004 > 2023 |                 |        |
| CRF    | 450        | 2002 > 2023 |                 |        |
| CRFX   | 250        | 2004 > 2017 |                 |        |
| CRFX   | 450        | 2005 > 2023 |                 |        |
| CRF-RX | 250        | 2019 > 2023 |                 |        |
| CRF-RX | 450        | 2017 > 2023 |                 |        |
| CRF-L  | 450        | 2019 > 2023 |                 |        |

REPLICA  
KAWASAKI

Kit viti a testa bombata con sottotesta cilindrico non filettato per dischi freno anteriore e posteriore per Suzuki RM-RMZ e Kawasaki KX -KXF.

La confezione contiene 4 viti zincate M6x13 per disco anteriore e 4 viti zincate M8x15 mm per disco posteriore. Su ogni vite è applicato del frenafiletto di resistenza media per una maggiore sicurezza e tenuta.



| MOD. | CILINDRATA | ANNO        | CODICE           | PREZZO |
|------|------------|-------------|------------------|--------|
| KX   | 65         | 2000 > 2023 | <b>2009SKRTR</b> | € 7,95 |
| KX   | 85-100     | 2001 > 2023 |                  |        |
| KX   | 125-250    | 2003 > 2007 |                  |        |
| KXF  | 250-450    | 2004 > 2023 |                  |        |
| KLR  | 650        | 1997 > 2018 | <b>KLRT650</b>   | € 7,95 |

REPLICA  
SUZUKI

| MOD. | CILINDRATA | ANNO        | CODICE            | PREZZO |
|------|------------|-------------|-------------------|--------|
| RM   | 65         | 2000 > 2012 | <b>2009SKRTR</b>  | € 7,95 |
| RM   | 80         | 1990 > 2001 | <b>SRTR8085</b>   | € 7,95 |
| RM   | 85         | 2002 > 2023 |                   |        |
| RM   | 125-250    | 2001 > 2008 | <b>SRTR125250</b> | € 7,95 |
| RMZ  | 250        | 2004 > 2023 | <b>2009SKRTR</b>  | € 7,95 |
| RMZ  | 450        | 2005 > 2023 |                   |        |
| DRZ  | 400        | All Years   | <b>DRZ400RTR</b>  | € 7,95 |

## REPLICA YAMAHA

Kit viti per dischi freno anteriore e posteriore per Yamaha YZ-YZF. La confezione è composta da 6 viti zincate M6x12 a testa svasata per disco anteriore e 6 viti zincate a testa flangiata M6x16 mm per disco posteriore.

Su ogni vite è applicato del frenafiletto di resistenza media per una maggiore sicurezza e tenuta.



| MOD.  | CILINDRATA | ANNO        | CODICE          | PREZZO |
|-------|------------|-------------|-----------------|--------|
| YZ    | 80         | 1993 > 2001 | <b>2009YRTR</b> | € 7,95 |
| YZ    | 85         | 2002 > 2023 |                 |        |
| YZ    | 125-250    | 1989 > 2023 |                 |        |
| YZ-X  | 125        | 2020 > 2023 |                 |        |
| YZ-X  | 250        | 2016 > 2023 |                 |        |
| YZF   | 250        | 2001 > 2023 |                 |        |
| YZF-X | 250        | 2015 > 2020 |                 |        |
| YZF   | 400        | 1998-1999   |                 |        |
| YZF   | 426        | 2000 > 2002 |                 |        |
| YZF   | 450        | 2003 > 2023 |                 |        |
| YZF-X | 450        | 2016 > 2023 |                 |        |
| WR    | 250 (2t)   | 1991 > 1997 |                 |        |
| WR    | 500 (2t)   | 1992-1993   |                 |        |
| WRF   | 250-450    | 2001 > 2023 |                 |        |

## REPLICA KTM

Kit viti a testa flangiata per dischi freno anteriore e posteriore KTM. Confezione da 12 viti M6x13.

Su ogni vite è applicato del frenafiletto di resistenza media per una maggiore sicurezza e tenuta.



| MOD.   | CILINDRATA | ANNO        | CODICE            | PREZZO |
|--------|------------|-------------|-------------------|--------|
| SX-EXC | 50 > 530   | 2001 > 2023 | <b>2009KTRMTR</b> | € 7,95 |

**ITALY DISTRIBUTION ONLY**

Viti M8 Classe resistenza 8.8 con testa ridotta per chiave esagonale da 10mm e relativo dado flangiato per chiave da 12mm. Confezione da 2 pezzi.



| MARCA      | DESCRIZIONE                       | COLORE  | CODICE         | PREZZO |
|------------|-----------------------------------|---------|----------------|--------|
| Universale | Viti registro catena 8.8 M8x50 MM | Zincato | <b>2006-CH</b> | € 4.95 |

**DADO RUOTA POSTERIORE**

Dado M22 classe di resistenza 8.8 per il bloccaggio del perno ruota posteriore completo di relativa rosetta di sicurezza. Sostituisce il dado originale KXF con copiglia.



| MARCA      | DESCRIZIONE                           | COLORE  | CODICE       | PREZZO |
|------------|---------------------------------------|---------|--------------|--------|
| Universale | Dado perno ruota post con rosetta M22 | Zincato | <b>AXN22</b> | € 4.95 |

**VITE FISSAGGIO SELLA SERBATOIO**

Vite fissaggio sella serbatoio alleggerita per moto giapponesi in alluminio anodizzato.

| MARCA      | DESCRIZIONE  | COLORE | CODICE       | PREZZO  |
|------------|--|--------|--------------|---------|
| UNIVERSALE | Vite fissaggio sella serbatoio per moto giapponesi | Rosso  | <b>BMHSB</b> | € 23.90 |



**SET GUARNIZIONI/VITERIA MARMITTA**

Contiene set guarnizioni in viton marmitta/cilindro, manicotto di accoppiamento marmitta/silenziatore e molle



Codice YZ.EX.250CC



Codice EU.EX.MNTS



Codice EU.EX.200-300CC

| MARCA          | MOD. | CIL.         | ANNO        | DESCRIZIONE          | CODICE                 | PREZZO  |
|----------------|------|--------------|-------------|----------------------|------------------------|---------|
| Replica YAMAHA | YZ   | 125          | 2001 > 2023 | Kit viteria marmitta | <b>YZ.EX.125CC</b>     | € 22.95 |
|                | YZ-X | 125          | 2021 > 2023 | Kit viteria marmitta |                        |         |
| Replica YAMAHA | YZ   | 250          | 2001 > 2023 | Kit viteria marmitta | <b>YZ.EX.250CC</b>     | € 22.95 |
|                | YZ-X | 250          | 2021 > 2020 | Kit viteria marmitta |                        |         |
| Replica KTM    | SX   | 50-60-85     | 2002 > 2023 | Kit viteria marmitta | <b>EU.EX.MNTS</b>      | € 20.95 |
|                | XC-W | 150-250-300  | 1998 > 2019 | Kit viteria marmitta |                        |         |
|                |      | 105-300 (2t) | 1998 > 2018 | Kit viteria marmitta |                        |         |
| Replica KTM    | SX   | 200          | 2011 > 2013 | Kit viteria marmitta | <b>EU.EX.200-300CC</b> | € 22.95 |
|                | SX   | 250-300      | 1999 > 2023 | Kit viteria marmitta |                        |         |
| Replica KTM    | SX   | 125-150      | 2000 > 2023 | Kit viteria marmitta | <b>EU.EX.105-150CC</b> | € 22.95 |
|                | SX   | 200          | 2000 > 2010 | Kit viteria marmitta |                        |         |
| Replica KTM    | SX   | 65-85        | 2002 > 2023 | Kit viteria marmitta | <b>EU.EX.65-85CC</b>   | € 22.95 |
|                | SX   | 105          | 2004 > 2011 | Kit viteria marmitta |                        |         |

**ITALY DISTRIBUTION ONLY**

Ricavata del pieno in lega di alluminio 6061 con rosetta forata integrata e con gambo filettato in acciaio solidale, dona un look "factory" alla vostra moto .

Disponibile in versione universale per applicazioni sui telai perimetrali di Suzuki RM -RMZ, Kawasaki KX-KXF e Yamaha YZ-YZF-WRF ed in versione specifica per Honda CR-CRF.



| MARCA                | MOD. | CIL.    | ANNO        | DESCRIZIONE                               | COLORE    | CODICE               | PREZZO  |
|----------------------|------|---------|-------------|---|-----------|----------------------|---------|
| Replica HONDA        | CR   | 125-250 | 2000 > 2007 | Vite serbatoio CRF                        | Alluminio | <b>2009GTBH</b>      | € 18,90 |
|                      | CRF  | 250     | 2004 > 2017 | Vite serbatoio CRF                        |           |                      |         |
|                      | CRF  | 450     | 2002 > 2016 | Vite serbatoio CRF                        |           |                      |         |
|                      | CRFX | 250-450 | 2004 > 2018 | Vite serbatoio CRF                        |           |                      |         |
| Japan Universal Bike | =    | =       | =           | Vite serbatoio universale moto giapponesi | Alluminio | <b>2009GTBKXRMZY</b> | € 18,90 |

**ROSETTE ALLEGGERITE**

Queste rosette alleggerite ricavate dal pieno in lega di alluminio 6061 si potevano vedere sino a qualche tempo fa solo sulle moto ufficiali. Disponibili in confezione da 1 pezzo nella versione colorata ed in confezioni da 10 pezzi nelle due versioni anodizzate silver.



Codice 2009AWW



Codice 2009WTWBL



Codice 2009WTWR



Codice 2009WTWY



Codice 2009AWW18



Codice 2009WTWG



Codice 2009WTWS

| DESCRIZIONE                                     | COLORE    | CODICE           | PREZZO |
|---|-----------|------------------|--------|
| Rosette alleggerite D25 mm. Confezione da 10 pz | Alluminio | <b>2009AWW25</b> | € 7,95 |
| Rosette alleggerite D18 mm. Confezione da 10 pz | Alluminio | <b>2009AWW18</b> | € 7,95 |
|   | Rosso     | <b>2009WTWR</b>  | € 4,95 |





Rtech è un marchio di Racetech S.r.l.  
Racetech S.r.l. non è responsabile per qualunque danno provocato dall'uso improprio dei prodotti presenti in questo catalogo.  
Gli articoli replica presenti in questo catalogo non sono prodotti originali e Rtech non ha alcuna connessione con i marchi delle case motociclistiche presenti in questo catalogo e/o con i suoi distributori.  
Tutti i prodotti con marchi registrati, nomi o sigle di identificazione dei motocicli si intendono esclusivamente come un riferimento per l'utilizzo di accessori di nostra produzione.  
Rif. all'art. 1 bis R.D. 21/06/1942 n. 929 e successivi.  
Dopo la pubblicazione (dicembre 2022) Racetech S.r.l. si riserva il diritto di cambiare articoli e prezzi presenti in questo catalogo senza preavviso.

Rtech is a trademark of Racetech S.r.l.  
Racetech S.r.l. is not liable for injuries suffered in the use of the items sited in this catalogue. Replica articles presented in this catalogue are no original products. Rtech has no connection with the brands of motorcycle manufacturers listed in this catalog and/or its distributors.  
All products with trademarks, names or acronyms of identification of motorcycles are considered only as a reference for the use of accessories of our production.  
Rif. art. 1a R.D. 21/06/1942 n. 929 and following.  
After publication date (december 2022) Racetech S.r.l. can change articles and prices presented in this catalogue without notice.



STARTING BLOCK



**PASSION  
RIDES  
HERE**

**PASSION  
RIDES  
HERE**

[WWW.RTECHMX.COM](http://WWW.RTECHMX.COM)



**RACETECH** SRL

Via Armentarezza, 5  
33040 Premariacco (UD)  
Tel. +39 0432 1616700  
[info@rtechmx.com](mailto:info@rtechmx.com)